

**AFTERMARKET
CATALOG** **14**

EXCEEDING EXPECTATIONS IN EVERYTHING WE DO



EXCEEDING CUSTOMER EXPECTATIONS IN EVERYTHING WE DO

Since our humble beginnings in 1953, when we pioneered advances in headlight aiming technology, Hopkins has grown and expanded over the years. The changes in the past several years have been significant. But one focus remains constant ... exceeding customer expectations in everything we do.

As we enter our seventh decade, Hopkins has grown into a sophisticated partner to our retail customers. We are one company, with multiple product categories, multiple consumer brands, and multiple operating locations. To better reflect our true capabilities, our location in Blenheim, Ontario has been named Hopkins Canada. It will remain the home of the Mallory® winter and squeegee brands. But over the course of 2014, we will begin making additional consumer product lines and brands available to better serve Canadian customers from this location. By mid-2014, a separate electronic catalog will be available to Canadian customers that includes the SKUs available from Blenheim.

We believe our growing array of consumer brands and products can help make your life as a buyer simpler and easier. Each of our brands follow a consistent

philosophy, including: leveraging consumer insights to drive product innovation, utilizing our breadth of channel experience to optimize planogram assortments, driving comparable store growth through our step-up products, and delivering end-user value through efficient manufacturing/sourcing strategies. This value creation strategy has helped our retail partners consistently out-pace the growth of the overall market.

Another important facet of this strategy is that every customer has just one primary contact person at Hopkins, from our team of sales professionals, who can facilitate the resources of Hopkins to bear on your business. Of course, our marketing teams are focused around product categories, where you can find the industry's greatest expertise in understanding the consumer and driving innovation through our brands and products.

Below find a chart to organize where our brands are distributed. Please make sure to consult your Hopkins Sales Manager as certain locations do not stock every SKU.



One Company. Multiple Categories. Multiple Brands. Multiple Locations.

Shipping & Distribution

Hopkins® delivers unequalled surge capacity

Hopkins® industry leading brands ship from three main production and distribution locations. Hopkins® also offers direct import for products manufactured over seas.

Outside The United States



Ciudad Juarez
Chihuahua, Mex



Ningbo
Zhejiang, China



Hopkins Canada
Blenheim
Ontario, Canada



Shipping For U.S. Customers



Carson
California

Carson, CA ships these product brands:

Carrand™
AutoSpa®
Pacific Coast™
Rain-X®



Emporia
Kansas

Emporia, KS ships these product brands:

Hopkins Towing Solutions®
SubZero®
Mallory®
GoGear®
Juice™
nVISION®
FloTool®
2x4 Basics®



Miami
Oklahoma

Miami, OK ships these product brands:

FloTool®
2x4 Basics®

CONTENTS

Page

New Products

4

Vehicle Cleaning

8

AutoSpa

10

Everyday Cleaning

20

Rain-X

32

Interior Auto Accessories

38

Floor Mats

40

Storage & Organization

46

Folding Sunshades

50

Pop-Up Sunshades

52

Merchandising

54

Snow & Ice Tools

56

Ice Scrapers

58

Snowbrushes

60

Snowbrooms

62

Accessories

66

Merchandising

68

Fluid Handling

70

Lift

72

Remove

74

Drain

76

Fill

78

Transfer/Recycle

81

Filter

82

Absorb

84

Floor Squeegees

85

Merchandising

88

Safety Accessories

92

Booster Cables

94

Back-Up Safety

96

Animal Alert

99

Tire Safety

100

2X4 Basics

102

Outdoor DIY Kits

104

DIY Organization Kits

106

Towing Solutions

108

Index

110



For more than a century, Mallory® has designed and manufactured innovative DIY products. Over the years Mallory developed a leading position in Canada for snow and ice tools

Their innovative design helped create the automotive window squeegee where they have the #1 position in North America

Hopkins Welcomes Mallory to Our Growing Family of Brands

The Hopkins toolbox just got bigger! Mallory, the leading snow & ice tool provider in Canada, expands the range of products we can offer drivers across North America

Mallory's innovative automotive squeegee range gives Hopkins the widest assortment of glass care tools available

The Best Just Got Better

Hopkins has the largest selection of winter weather tools in the world

- This means that we have the greatest insights into winter weather, the best knowledge about what assortment is right for each channel and customer, and an unmatched capacity to respond to in-season winter storms
- A single partner who can help you become the most effective and efficient retailer of snow and ice tools and glass care products ever



Hopkins ...
Better Than Ever



9271X
8" Squeegee with 39" Extension



PAGE
32



9425CDX
Liquid-Filled 8" Spray Squeegee



PAGE
32



9438X
Compact 8" Squeegee



PAGE
32



9272X
Premium 8" Squeegee w/20" Handle Gas Station Squeegee



PAGE
32



45137X
Swiper™ Drying Mitt



PAGE
33



45544X
Triple Blade Glass Tool



PAGE
33

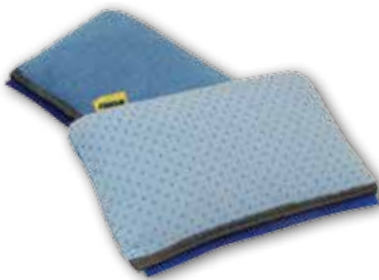

45619X
3-in-1 Window Blade



PAGE
33



45116X
2-Sided Microfiber Defogger Sponge



PAGE
33



45078X
Microfiber Window Mate



PAGE
33



Leverage Rain-X® brand equity to promote and cross-sell in your planogram



The Rain-X trademarks are licensed property owned by Illinois Tool Works, Inc.



45122X
2-Sided Bug & Tar Sponge



PAGE
33



90063
50 ft. Quick Connect
Car Wash Hose



PAGE
20



90043
Bullet Nose Nozzle



PAGE
20



94108VA
94109VA
3 Gallon Specialty
Car Wash Bucket Kits



PAGE
20



Introducing GoGear[®] Heavy-Duty Floor Mats

Multi-Point Locking™
Secures Mat Firmly In Place

Long-Lasting Protection
With Double Layer Heel Guard

Exact Fit
Using Easy Trim Guides

**ULTIMATE
PROTECTION**

Engineered to address the needs of
Truck, SUV and Crossover owners

- GoGear floor mats are engineered with the fit, durability and security sought by Truck, SUV and Crossover owners at a fraction of the cost of custom mats. This innovation will help convert your shoppers into satisfied customers.
- Replace your slowest selling SKUs with GoGear, make some noise, and watch your sales soar!

Multiple Parts
Full-Size and Mid-Size
Heavy-Duty Floor Mat Sets



PAGE
44



79080
16-Set Heavy-Duty
Floor Mat Metal Rack Display



PAGE
55



SP120916
Tiger Eye
Premium Folding Sunshade



PAGE
51

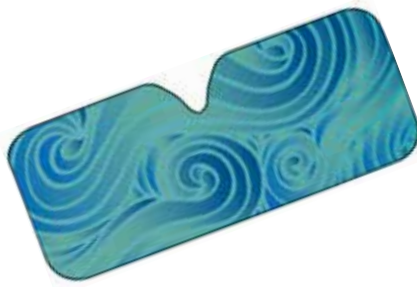

SP120912
Pacific Vibe
Premium Folding Sunshade



PAGE
51



SP240612
Pacific Vibe
Pop-Up Sunshade



PAGE
52



18520
Power Series 26" Snowbrush



PAGE
60



12550
Boot Tray



PAGE
66



10835MI
Drain Container
Replacement Caps



PAGE
77



10836MI
Drain Container
Replacement Plugs



PAGE
77



10202
FloTool
High Performance
Absorbent
3 oz. Trial Size Bag



PAGE
84



Multiple Parts
Mallory Floor Squeegees



PAGE
86





Hopkins® has become the cleaning solutions leader through our understanding and insight into core consumer needs.

The guiding development principle is centered on innovation, bringing over 30 years of cleaning solutions to the marketplace.

We deliver on this promise by understanding the consumer’s need for innovation, design, functionality and quality. This understanding is partnered with an emphasis and commitment to quality assurance.

Our long-term success has marked us as the industry leader in the vehicle cleaning solutions category. These core ideas have laid the foundation for our growth and we are continually adding to this extensive list of innovations.

We are changing the way cleaning tools are used by understanding the consumers need for innovation, design, functionality & quality, while creating breakthrough ideas to build value for every one of our customers.

Branding Strategies That Maximize Your Planogram Potential



- AutoSpa™ is the premium accessory market leader
- Complements all premium chemicals, and brings innovations that elevate the cleaning experience



- Carrand™ is the everyday vehicle cleaning leader
- Most complete product range, offering solutions across every category segment



- The most trusted name in glass care
- Innovative specialty solutions that create new everyday and incremental opportunities



- Mallory developed the market leading position in the automotive window squeegee category where we have the #1 position in North America
- Mallory’s innovative automotive squeegee range gives us the widest assortment of glass care tools available to service all of your shoppers needs



AUTOSPA™

LUXURY CAR CARE

Made for automotive enthusiasts who want nothing but the best when caring for their vehicles, AutoSpa Luxury Car Care Accessories prolong that “fresh from the show room” feel through superior design, quality, and value.

Through the years automotive materials and finishes have changed. Consumers are increasingly aware and wary of what they apply to their vehicles and how they take care of them.

AutoSpa Luxury Microfiber MAX materials take car washing to a whole new level of finish. Industry firsts include Luxury coral fleece, premium polyester mesh, and no-snag satin edging to deliver a premium look from the shelf and superior performance for the end user.

Whatever your car care task - washing, drying, polishing, or detailing - nothing says you're in good hands like AutoSpa.



POWERED CAR CARE



PROFESSIONAL LONG POLES

Luxury Car Care for The Enthusiast In All Of Us

Offering The Ultimate In Features and
Performance Creates Step-Up
Profit Opportunities



PROFESSIONAL HAND TOOLS



PREMIUM SOFT GOODS

Auto-Vac Bagless Vacuum™

- Powerful Suction Cleans Fast
- Custom Accessories with Cord Storage
- Compact Lightweight Design

Random Orbital Polishers

- Low Vibration Heavy Duty Motor
- Integrated Multi-Grip™ for Reaching and Less Fatigue
- 3-Layer Buffing Wheel with Visible Moisture Barrier



Tools
Included

94005AS
Auto-Vac 120v Bagless Vacuum

4 pcs.

OPEN STOCK	TRAY PACK	CLIP STRIP	OFF SHELF	FLOOR DISPLAY	PALLET
------------	-----------	------------	-----------	---------------	--------

 94005AS

- Heavy-Duty 560 watt - 120v motor ETL approved
- Professional in-line air flow design
- Includes carpet, console, crevice and blower tools with handy on-board storage



NEW DESIGN
94001AS
10" Random Orbital Polisher with Bonus Bonnets

1 pcs.

OPEN STOCK	TRAY PACK	CLIP STRIP	OFF SHELF	FLOOR DISPLAY	PALLET
------------	-----------	------------	-----------	---------------	--------

 94001AS

- Heavy-Duty 3600 rpm-120v motor UL approved
- 3-layer foam pad with moisture barrier
- Includes foam applicator bonnet & microfiber removal bonnet



94000AS
6" Random Orbital Polisher with Bonus Bonnets

2 pcs.

OPEN STOCK	TRAY PACK	CLIP STRIP	OFF SHELF	FLOOR DISPLAY	PALLET
------------	-----------	------------	-----------	---------------	--------

 94000AS

- Heavy-Duty 3500 rpm-120v motor UL approved
- 3-layer foam pad with moisture barrier
- Includes foam applicator bonnet & microfiber removal bonnet



97371AS
2-Sided Bonnet Brush

72 pcs.

OPEN STOCK	TRAY PACK	CLIP STRIP	OFF SHELF	FLOOR DISPLAY	PALLET
------------	-----------	------------	-----------	---------------	--------

 97371AS

- 2-in-1 Bonnet cleaning tool
- Restores bonnets to new
- Works on cotton, microfiber & wool bonnets



44%

MORE AIR FLOW*

**More Air Flow...
More Cleaning Power!**

Air Flow CFM (cubic feet per minute) Comparison*

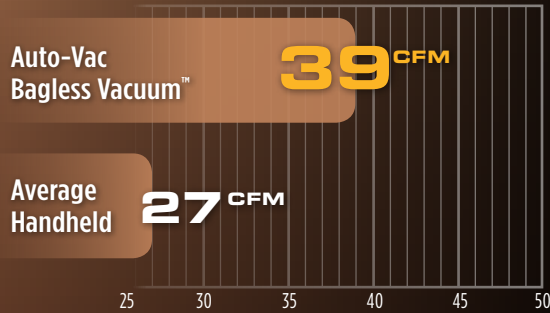

* Independently Verified



Minimal resistance design allows air to flow more freely for more cleaning power

STEP UP FROM COTTON



COTTON

**IRREGULAR SURFACE
UNEVEN APPLICATION**

PROFESSIONAL

FOAM

**SMOOTH SURFACE
SMOOTH, EVEN APPLICATION**



Multiple Parts 1pk Synthetic Wool Polishing Bonnet

48 pcs.

OPEN STOCK TRAY PACK CLIP STRIP OFF SHELF FLOOR DISPLAY PALLET

See Below

- Elastic edge keeps bonnet snug
- Extra soft for buffing & finish polishing
- Excellent for final buffing to shine

40405AS - 9-10" Wool Bonnet

40404AS - 7-8" Wool Bonnet

40403AS - 5-6" Wool Bonnet



Multiple Parts 2pk Microfiber Polishing Bonnet

48 pcs.

OPEN STOCK TRAY PACK CLIP STRIP OFF SHELF FLOOR DISPLAY PALLET

See Below

- Elastic edge keeps bonnet snug
- Premium soft microfiber for removing & polishing
- Excellent for waxes and polishes

40408AS - 9-10" Microfiber Bonnet

40407AS - 7-8" Microfiber Bonnet

40406AS - 5-6" Microfiber Bonnet



Multiple Parts 1pk Foam Application Bonnet

48 pcs.

OPEN STOCK TRAY PACK CLIP STRIP OFF SHELF FLOOR DISPLAY PALLET

See Below

- Elastic edge keeps bonnet snug
- Smooth for professional even application
- Excellent for waxes, polishes and compounds

40411AS - 9-10" Foam Bonnet

40410AS - 7-8" Foam Bonnet

40409AS - 5-6" Foam Bonnet



Multiple Parts Cotton Terry Application Bonnet

6/48 pcs.

OPEN STOCK TRAY PACK CLIP STRIP OFF SHELF FLOOR DISPLAY PALLET

See Below

- Elastic edge keeps bonnet snug
- Soft for applying & removing
- Excellent for waxes, polishes

45401AS - 9-10" 6pk Cotton Bonnet

40402AS - 9-10" 2pk Cotton Bonnet

40401AS - 7-8" 2pk Cotton Bonnet

40400AS - 5-6" 2pk Cotton Bonnet



**Integrated Grip Assists
Extends Reach, Reduces Fatigue**



**Built-In Kick-Stand
Prevents Pad Contamination**



**Bonnet Brush
Restores Bonnets to New**

PREMIUM VEHICLE CLEANING

Professional Flow-Thru And Dip Brushes

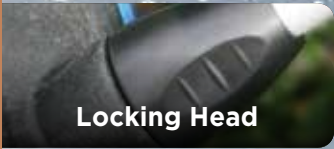

Locking Head



ABS Components



Hardened Aluminum

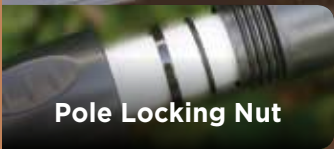

Pole Locking Nut

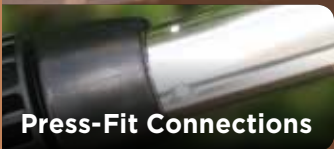

Press-Fit Connections



Slide Water Control



Extends to
68" ▶▶▶▶

93072 **FLOW-THRU™**
10" Quad Head Wash Brush with
68" Extension Pole

6
pcs.

OPEN
STOCK

93072

12
pcs.

FLOOR
DISPLAY

93072D

- All-sided quad brush cleans all surfaces easily and quickly
- Telescoping pole with no-spin locking head
- Variable slide water control with hose swivel

The premium accessory market leader helps create step up opportunities to maximize your planogram profits



93097 FLOW-THRU™
10" Bi-Level Wash Brush
with 68" Extension Pole

6
 pcs.
 OPEN STOCK
 93097

12
 pcs.
 FLOOR DISPLAY
 93097D

- 10" super soft bi-level brush head with fan spray rinse
- Telescoping pole with no-spin locking head
- Variable slide water control with hose swivel



NEW DESIGN

93303
Microfiber Chenille Wash Mop
with 48" Extension Pole

6
 pcs.
 OPEN STOCK
 93303

12
 pcs.
 FLOOR DISPLAY
 93303D

- Extra absorbent long chenille microfiber wash bonnet
- Telescoping pole
- Washglove can be removed from pole for professional hand car wash

Bucketless Car Wash Solutions



On-board soap-mixing chamber



Integrated on/off control

The Hopkins Bucketless Car Wash Solutions continue to gain marketplace momentum by making it easier than ever to clean passenger and family vehicles. Using our patented on-board soap mixing system with integrated on/off soap control; the bucketless car wash solutions family is the fastest route to a clean vehicle anywhere.

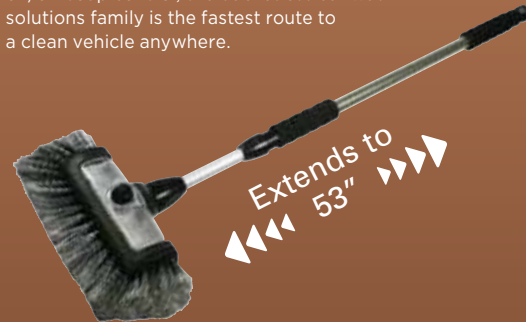

NEW DESIGN

93977 FLOW-THRU™
Power Wash 10" Quad Soap Mixing Brush
with 53" Flow-Thru Extension Pole

6
 pcs.
 OPEN STOCK
 93977

12
 pcs.
 FLOOR DISPLAY
 93977D

- All-sided quad brush cleans all surfaces easily and quickly
- Telescoping pole with no-spin locking head
- On/Off control allows for minimal water usage



93984 FLOW-THRU™
10" Suds-N-Go Bi-Level Wash Brush
with 68" Extension Pole

6
 pcs.
 OPEN STOCK
 93984

12
 pcs.
 FLOOR DISPLAY
 93984D

- 10" soap bi-level brush head with rubber bumpers
- Telescoping pole with no-spin locking head
- Variable slide water control with hose swivel

Hand Tool Innovations Get a Grip on Cleaning Quality Inside & Out

GRIP TECH™

AutoSpa® Professional Hand Brushes with patented Grip-Tech™ technology bring high tech design to the hand brush segment



92025 **GRIP TECH™**
Deluxe Body Brush

24
pcs.

OPEN STOCK

TRAY PACK

CLIP STRIP

92025

- Soft bristles clean wheels, fender and body
- Side protective bumper
- Soft rubber handle for comfort and function



92036 **GRIP TECH™**
Deluxe Tire & Bumper Brush

24
pcs.

16
pcs.

OPEN STOCK

TRAY PACK

CLIP STRIP

92036

92036D

- Stiff bristles clean bumper, grill and tire
- Soft rubber handle for comfort & function
- Side protective bumper



92014 **GRIP TECH™**
Deluxe Contoured Tire Brush

36
pcs.

OPEN STOCK

TRAY PACK

CLIP STRIP

92014

- Contours to tire shape
- Soft rubber handle for comfort & function
- Can attach to any standard pole

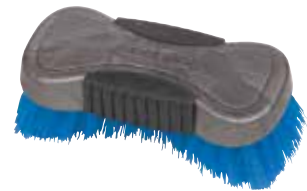

92011 **GRIP TECH™**
Deluxe Tire Brush

36
pcs.

OPEN STOCK

TRAY PACK

CLIP STRIP

92011

- Stiff bristles designed for tires
- Soft rubber handle for comfort & function
- Contours to tire shape



92012 **GRIP TECH™**
Deluxe Wheel & Brake Dust Brush

36
pcs.

24
pcs.

OPEN STOCK

TRAY PACK

CLIP STRIP

92012

92012D

- Strong scour pad action removes brake dust from wheel
- Outer soft bristle to clean wheels while protecting the new wheel finish
- Soft rubber handle for comfort & function



92010 **GRIP TECH™**
Deluxe Double Loop Wheel Brush

36
pcs.

24
pcs.

OPEN STOCK

TRAY PACK

CLIP STRIP

92010

92010D

- Patented mount design holds bristles
- Soft rubber handle for comfort & function
- Two separate durable bristle loops for complete cleaning



92018 **GRIP TECH™**
Deluxe Interior Brush

36
pcs.

OPEN STOCK

TRAY PACK

CLIP STRIP

92018

- Super stiff bristles to remove dirt from carpet or upholstery
- Flared bristles for hard to reach areas
- Soft rubber handle for comfort and function

Professional Specialty Cleaning Tools



97373AS Bend & Wash™ Wheel Cleaner

24
pcs.

OPEN STOCK TRAY PACK CLIP STRIP

97373AS

- 2-in-1 premium microfiber
- Built-In Bend & Wash™ Core for hard to reach areas
- Bendable & safe on all surfaces



Multiple Parts 2-in-1 Electrostatic Detail Brush

48/36
pcs.

OPEN STOCK TRAY PACK CLIP STRIP

92049, 92052

- Electrostatic charge picks up dust
 - Vent duster brush
- 92049 - Detail Brush, 48 pcs.
92052 - with air brush, 36 pcs.



97372AS MICROFIBER MAX Inside Shine Interior Duster

24
pcs.

OPEN STOCK TRAY PACK CLIP STRIP

97372AS

- Pulls dust from interior surfaces
- Lint free interior dusting
- Keep in car, take anywhere



92004 Deluxe Detail Brush Set

72
pcs.

OPEN STOCK TRAY PACK CLIP STRIP

92004

- Soft nylon brush for hard to reach areas
- Tough brass for cleaning battery terminals and spark plugs
- Stainless steel for body and bumper rust



92034 **GRIP TECH** Deluxe Dust Pan & Broom

36
pcs.

OPEN STOCK TRAY PACK CLIP STRIP

92034

- Wide basin dust pan with rubber edge
- Super stiff bristles for easy cleaning
- Soft rubber handle for comfort and function



97370AS MICROFIBER MAX Body Shine Dusting Wand

24
pcs.

OPEN STOCK TRAY PACK CLIP STRIP

97370AS

- 20" extended reach
- Push Microfiber strands grab & hold surface dust
- Washable and completely reusable
- Cleans car without water & safe on all auto finishes

Premium Materials Take Car Care To a Whole New Level of Finish

MICROFIBER MAX™

Luxury Chenille Fibers

build suds for a professional wash

Plush Deep Pile Fibers

lift and carry away dirt & debris

Poly-Mesh™ Netting

removes bugs, tar and surface deposits

Luxury Satin Edging

will not snag on wipers, trim or emblems



40305
Sheepskin Wash Mitt

24 pcs.

OPEN STOCK TRAY PACK CLIP STRIP
40305

- 92% Sheepskin (Mitt); 8% Polypropylene (Cuff)
- Super deep genuine sheepskin lifts dirt from surface
- Perfect polishing mitt when used dry
- Elastic cuff keeps mitt snug



45133
Microfiber Chenille Wash Pad

24 pcs.

OPEN STOCK TRAY PACK CLIP STRIP
45133

- Professional detailing
- Easy to grab and wash
- Microfiber super suds maker holds more soap & water



45135
Suds-N-Scrub Microfiber 2-in-1 Chenille Wash Pad

24 pcs.

OPEN STOCK TRAY PACK CLIP STRIP
45135

- Professional detailing
- Easy to grab and wash
- Microfiber scrub netting safely cleans tough spots & debris



45602AS **MICROFIBER MAX™**
Total Clean All Over Body Mitt

12 pcs.

OPEN STOCK TRAY PACK CLIP STRIP
45602AS

- 4-in-1 Waterproof wash mitt
- Suds-Maker luxury chenille fibers
- Scratch & lint free professional wash
- Elastic cuff keeps mitt snug



45610AS **MICROFIBER MAX™**
Suds-N-Scrub Body Wash Mitt

12 pcs.

OPEN STOCK TRAY PACK CLIP STRIP
45610AS

- 2-in-1 Suds-N-Scrub Body Wash Mitt
- Dual layer fibers make lots of suds
- Scratch & lint free professional wash
- Foam lined for added absorbency



45604AS **MICROFIBER MAX™**
Premium Body Sponge

12 pcs.

OPEN STOCK TRAY PACK CLIP STRIP
45604AS

- 2-Sided scrub & wash design
- Plush deep pile fibers for a professional wash
- Poly-Mesh™ netting gently scrubs
- Heavy-duty foam sponge core

Premium Detailing Accessories

Soft, Absorbent, Versatile...

45625AS 6pk Spa-Soft Detailing Towels

12
pcs.

OPEN STOCK

TRAY PACK

CLIP STRIP

45625AS

- 100% polyester microfiber is ultra plush and has a luxury feel from the shelf (12" x 16")
- Premium HYDRO-MAX™ treatment makes these towels super absorbent compared to competitors
- Color band edging helps prevent cross contamination of chemicals
- Perfect for washing, drying, polishing, detailing



SPA-SOFT ADVANTAGE

Absorbs Fast

Spa-Soft with HYDRO-MAX™

Competitors

Slow to Absorb

2x Faster Absorption



40059AS MICROFIBER MAX™ Supreme Drying Towel

24
pcs.

OPEN STOCK

TRAY PACK

CLIP STRIP

40059AS

- Super large 5.5 sq. ft. size dries more area faster (22" x 36")
- Scratch, lint & streak free microfiber
- Holds 7 times its weight in water & cleans as it dries
- No Snag Satin Edging

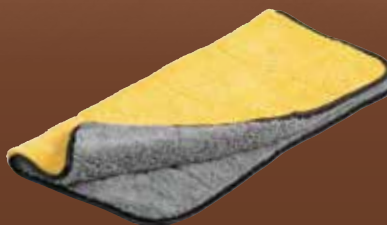

45606AS MICROFIBER MAX™ Soft Touch Detailing Towel

12
pcs.

OPEN STOCK

TRAY PACK

CLIP STRIP

45606AS

- 2-Sided towel for interior & exterior dusting, polishing & detailing (16" x 16")
- Plush deep pile luxury fibers
- Scratch & lint free detailing
- No chemicals needed

GLASS | BODY | WHEEL



45630AS MICROFIBER MAX™ Specialty Detailing Set

12
pcs.

OPEN STOCK

TRAY PACK

CLIP STRIP

45630AS

- **Glass Towel:** 2-Sided Clean & Dry
- **Body Towel:** 2-Sided Dry & Polish
- **Wheel Towel:** 2-Sided Scrub & Wash
- No Snag Satin Edging (14" x 14")

Multiple Parts Premium Chamois

24
pcs.

OPEN STOCK

TRAY PACK

CLIP STRIP

SEE BELOW



- 100% all natural sheepskin chamois
- Superior tanning for extra absorbency
- Quickly dries any surface.

- 40200AS - 2 sq. ft.
- 40201AS - 2.5 sq. ft.
- 40202AS - 3 sq. ft.
- 40203AS - 3.5 sq. ft.
- 40204AS - 4 sq. ft.
- 40205AS - 4.5 sq. ft.
- 40206AS - 5 sq. ft.



Scrub

Wash



Clean

Dry

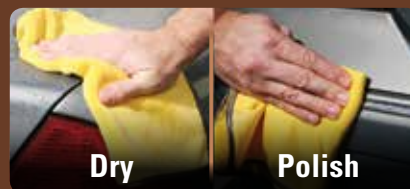

Dry

Polish

PREMIUM VEHICLE CLEANING



WATER MANAGEMENT

Core Item Solutions that Provide Innovation & Profit Potential

Quickly Connect All Your Car Wash Cleaning Devices

Universal connector system allows for easy switching between nozzles, brushes and other flow-through tools

NEW 90063 50 ft. Quick Connect Car Wash Hose With Two Connect Adapters

4 pcs.
OPEN STOCK 90063 TRAY PACK OFF SHELF

- Heavy duty 3-ply kink resistant hose
- Water saving auto shut-off feature
- Universal household hose bib swivel connector



Easy to use ...



Thread universal adapter onto cleaning device



Pull back quick-connect coupler and attach to universal adapter



Disconnect devices by pulling back on quick-connect and disengage from adapter



94102N 3 gal. (12 qt.) Specialty Car Wash Bucket

36 pcs.
OPEN STOCK 94102N TRAY PACK OFF SHELF

- Exclusive design made of high impact plastic
- Accommodates up to 10" wash brush head
- Ergonomic handle with integrated towel rest

94109VA - (6 pc. Bucket) Includes: 3 ea. Terry Towel; 1 ea. 2-in-1 Chenille Mitt; 1 ea. Nylon Bug Sponge & 1 ea. 3 gal. Bucket

94108VA - (10 pc. Bucket) Includes: 3 ea. Microfiber Towel; 2 ea. Microfiber Applicator Pad; 1 ea. Microfiber Wheel Detailer; 1 ea. Microfiber Wash Mitt; 1 ea. Lug Nut Brush; 1 ea. Gripper Handle; 1 ea. 3 gal. Bucket



Integrated Wash Board



Wide Mouth Design



NEW Wash Bucket Kits



90051 Fire Hose Nozzle with On/Off

48 pcs. 24 pcs.
OPEN STOCK 90051 TRAY PACK 90051D OFF SHELF SIDE KICK FLOOR DISPLAY

- Jet sprays over 40 Feet
- Adjustable from jet to rinse
- Easy on/off water control



NEW 90043 Bullet Nose Nozzle

100 pcs.
OPEN STOCK 90043 TRAY PACK OFF SHELF SIDE KICK FLOOR DISPLAY

- Heavy duty metal core
- Instant on/off action
- Over-molded for added grip and control



90016 Insulated Trigger Nozzle

60 pcs.
OPEN STOCK 90016 TRAY PACK OFF SHELF SIDE KICK FLOOR DISPLAY

- Industrial grade nozzle
- Protects hands from hot and cold water
- Threaded tip protective cap





90049
Fire Hose Nozzle

48 pcs.	24 pcs.			
OPEN STOCK	TRAY PACK	OFF SHELF	SIDE KICK	FLOOR DISPLAY
90049	90049D			

- Jet sprays over 40 Feet
- Adjustable from jet to rinse



90042
8-Way Spray Nozzle

60 pcs.				
OPEN STOCK	TRAY PACK	OFF SHELF	SIDE KICK	FLOOR DISPLAY
90042				

- Spray patterns from mist to jet
- Full insulated trigger grip
- Protects hands from hot and cold water



90015
Insulated Trigger Nozzle

100 pcs.				
OPEN STOCK	TRAY PACK	OFF SHELF	SIDE KICK	FLOOR DISPLAY
90015				

- Soft insulated cushion grip
- Protects hands from hot and cold water
- Threaded tip protective cap

Patented Soap-Mixing Technology for Auto & Home



92215
Wash-Jet™ Power Wand

6 pcs.				12 pcs.
OPEN STOCK	TRAY PACK	OFF SHELF	SIDE KICK	FLOOR DISPLAY
92215				92215D

- Easily fills with any car wash soap
- Mixes soap & water automatically - no bucket needed
- Molded rubber protective spray tip, trigger lock & hose swivel control

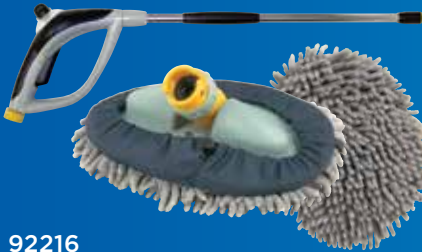

92216
Wash-Jet™ Power Wand with Microfiber Wash Pad

6 pcs.				12 pcs.
OPEN STOCK	TRAY PACK	OFF SHELF	SIDE KICK	FLOOR DISPLAY
92216				92216D

- Easily fills with any car wash soap
- Mixes soap & water automatically - no bucket needed
- Pivoting microfiber wash pad

Blast Away Dirt, Grime & Debris

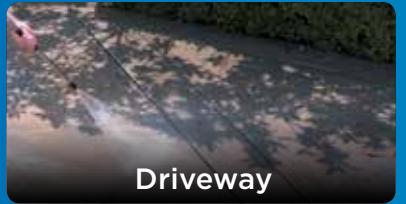

90005
Metal Trigger Nozzle

100 pcs.				
OPEN STOCK	TRAY PACK	OFF SHELF	SIDE KICK	FLOOR DISPLAY
90005				

- Threaded end for attachments
- Provides on/off and adjustable spray
- All metal construction



92217
Wash-Jet™ Power Wand with 3-Way Adjustable Nozzle

6 pcs.				12 pcs.
OPEN STOCK	TRAY PACK	OFF SHELF	SIDE KICK	FLOOR DISPLAY
92217				92217D

- Easily fills with any car wash soap
- Mixes soap & water automatically - no bucket needed
- 3-Way adjustable nozzle



LONG POLE LEADER

Innovative Long Pole Wash Solutions



Hopkins® is the market leader in the ever-growing long pole wash category. Our patented designs have innovative features that cannot be found on any competitor's product. Thirty years of car care experience in packaging, brush fibers, spray patterns, and pole configurations give customers virtually unlimited choices for their car care needs.

RELENTLESS INNOVATION...



Locking Head



ABS Components



Hardened Aluminum

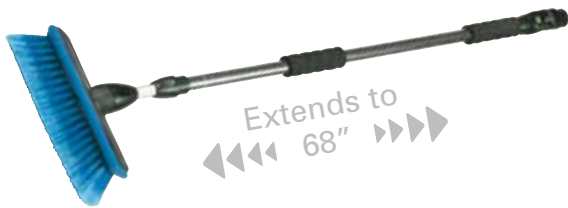

Extends to
68" ▶▶▶▶

93089 **FLOW-THRU** 10" Wash Brush with 68" Extension Pole

6 pcs.

OPEN STOCK
93089

TRAY PACK

OFF SHELF

SIDE KICK

12 pcs.

FLOOR DISPLAY
93089D

- Super soft brush with fan spray rinse and rubber bumper
- Telescoping pole with No-spin locking head
- Variable-Slide water control with hose swivel



Extends to
65" ▶▶▶▶

Multiple Parts **FLOW-THRU** 8" Wash Brush with Extension Pole

6 pcs.

OPEN STOCK

TRAY PACK

OFF SHELF

SIDE KICK

12 pcs.

FLOOR DISPLAY

See Below

SEE PAGE 34

- Super soft brush with fan spray rinse and rubber bumpers
 - Telescoping pole with On/Off water control
- 92022S - 8" Wash Brush with 40" Extension Pole
93052 - 8" Wash Brush with 65" Extension Pole
93055 - 8" Wash Brush with 28" Pole



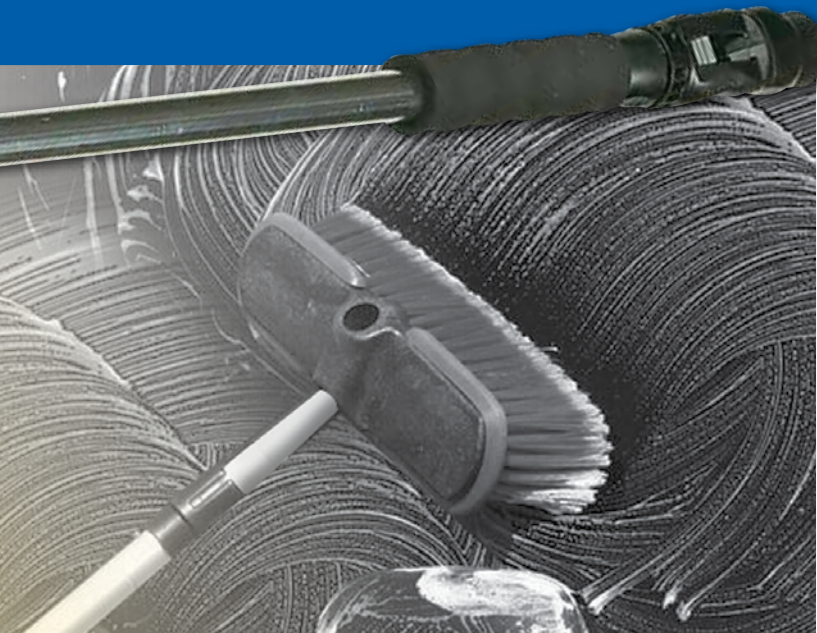

93060
8" Bi-Level Wash Brush with 48" Pole

6 pcs.

OPEN STOCK

93060

TRAY PACK

OFF SHELF

SIDE KICK

12 pcs.

FLOOR DISPLAY

93060D

- Super soft bi-level wash brush
- Super strong all metal pole
- Plastic molded grip

...YIELDS SUPERIOR PRODUCTS



93062
10" Wash Brush with 65" Extension Pole

8 pcs.

OPEN STOCK

93062

TRAY PACK

OFF SHELF

SIDE KICK

12 pcs.

FLOOR DISPLAY

93062D

- Super soft brush with rubber bumpers
- Telescoping pole
- Foam grips for extra control



Multiple Parts
Wash Brush with 48" Handle

6 pcs.

OPEN STOCK

93058, 93053

TRAY PACK

OFF SHELF

SIDE KICK

12 pcs.

FLOOR DISPLAY

SEE PAGE 34

- Super soft brush with rubber bumper
 - Super strong all metal pole with plastic molded grip
- 93058** - 10" Wash Brush
93053 - 8" Wash Brush





HAND TOOL INNOVATIONS

Setting the Standard for Cleaning Quality Inside and Out



Over-Molded Grip

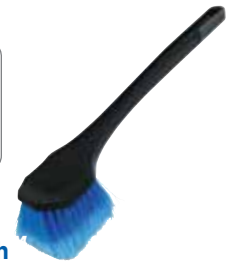

Multiple Parts 20" Body Brush

36 pcs.

OPEN STOCK

TRAY PACK

OFF SHELF

93039, 94039

- Extra long handle for wheel and body
- Super soft bristles
- Comfort molded handle

93039 - 20" Body Brush

94039 - with over-molded grip



Over-Molded Grip



Multiple Parts Body Brush

24 pcs.

OPEN STOCK

16 pcs.

TRAY PACK

OFF SHELF

93025, 94025

93025D

- Soft bristles clean wheel, bumper & body
- Comfort molded handle

93025 - Body Brush

94025 - with over-molded grip



Over-Molded Grip



Multiple Parts Tire & Bumper Brush

72 pcs.

OPEN STOCK

16 pcs.

TRAY PACK

OFF SHELF

93036, 94036

93036D

- Stiff bristles clean bumper, grill and tire
- Comfort molded handle

93036 - Tire and Bumper Brush

94036 - with over-molded grip



Over-Molded Grip



Multiple Parts Interior Brush

72 pcs.

OPEN STOCK

TRAY PACK

OFF SHELF

93018, 94018

- Durable scrubbing bristles
- Stiff carpet brush
- Easy grip handle

93018 - Interior Brush

94018 - with over-molded grip



94037 Plunge & Scrub Spoke Brush

72 pcs.

OPEN STOCK

TRAY PACK

OFF SHELF

94037

- All sided cleaning
- Safe with most wheel finishes
- Comfort molded handle



92017 2-in-1 Microfiber Wheel Detailer

36 pcs.

OPEN STOCK

24 pcs.

TRAY PACK

OFF SHELF

92017

92017D

- Super soft microfiber detailer with side scrubbing panels
- Comfort molded handle
- Safe on all types of wheels



Over-Molded Grip



Multiple Parts Wheel Brush

72 pcs.

OPEN STOCK

TRAY PACK

OFF SHELF

93012, 94012

- Non-scratch soft bristles
- Safe with most wheel finishes
- Comfort molded handle

93012 - Wheel Brush

94012 - with over-molded grip



Contoured Bristles



93027 Contour Tire Brush

36 pcs.

OPEN STOCK

TRAY PACK

OFF SHELF

93027

- Super stiff bristles designed for tires
- Contours to tire shape
- Comfort molded handle

93047 Tire Shine Applicator

36 pcs.

OPEN STOCK

TRAY PACK

OFF SHELF

93047

- Quickly and easily applies tire dressing
- Contours to tire shape
- Comfort molded handle





92016
Deluxe Tire & Bumper Brush

24 pcs.

OPEN STOCK
92016

TRAY PACK

OFF SHELF

- Super tough brass bristles
- Cleans white/black wall tires & corrosion
- Thumb and finger position for extra scrubbing pressure



92046
Interior/Exterior Detail Brush

48 pcs.

OPEN STOCK
92046

TRAY PACK

24 pcs.

OFF SHELF
92046WR

- Soft bristles are perfect for dusting vents and dash and hard to get areas
- TPR tip removes dirt and grime from seams



93112
Lint & Hair Removal Brush

24 pcs.

OPEN STOCK
93112

TRAY PACK

OFF SHELF

- Electrostatic bristles attract hair & fur like a magnet
- Removes hair, lint, & fuzz from upholstery and carpets
- 100% natural rubber bristles - will not scratch or scuff



92047
Finger Loop Scrub Brush

48 pcs.

OPEN STOCK
92047

TRAY PACK

12 pcs.

OFF SHELF
92047WR

- Durable easy clean curved bristles clean fingernails and crevices
- TPR rubber sure grip



92019
Deluxe Lug Nut Brush

24 pcs.

OPEN STOCK
92019

TRAY PACK

12 pcs.

OFF SHELF
92019WR

- Patented design cleans all sides of lug nut quickly and easily
- Works on all detailing areas of wheel, lug nut-stem-rim
- Fits all lug nut sizes



93043
Vent Brush

144 pcs.

OPEN STOCK
93043

TRAY PACK

24 pcs.

OFF SHELF
93043WR

- Removes dust and dirt from hard to reach areas
- Stiff natural fibers



93019
Detail Brush Set

48 pcs.

OPEN STOCK
93019

TRAY PACK

OFF SHELF

- 2-Sided vent louver detailer
- Dust & crevice brush
- Vent and seam detailer



93044
2-in-1 Detail Brush

48 pcs.

OPEN STOCK
93044

TRAY PACK

OFF SHELF

- Dash dusting fibers
- Vent and detail brush
- Perfect for vents & seams



93034
Dust Pan & Broom

72 pcs.

OPEN STOCK
93034

TRAY PACK

OFF SHELF

- Plastic pan and broom set
- Assorted colors



93028
Whisk Broom, 10" with Label

72 pcs.

OPEN STOCK
93028

TRAY PACK

OFF SHELF

- Use in home or truck
- Natural fibers
- Metal hanger loop



Multiple Parts
Contour Tire Wipe

24 pcs.

OPEN STOCK
92043, 92143

TRAY PACK

12 pcs.

OFF SHELF
92043WR

- Handle keeps hands away from chemicals
- Contoured handle shapes foam to the tire surface

92043 - Contour Tire Wipe

92143 - Contour Tire Wipe, 2 pcs.





EVERYDAY SOFT GOODS SOLUTIONS

Setting the Cleaning Standard



Formulations

- Professional grade performance microfiber
- Over 30 materials and combinations for every cleaning task



Functionality

- Superior ergonomics and ease of use
- Class leading consumer insights



Side scrub netting

40310 Microfiber 3-in-1 Waterproof Wheel & Body Wash Mitt

24
pcs.

OPEN
STOCK
40310

TRAY
PACK

OFF
SHELF

- Waterproof lining keeps hands dry and clean
- 2-sided for separate body and wheel cleaning
- Side microfiber scrub netting safely cleans tough spots & debris



40309 Microfiber Long Chenille Wash Mitt

24
pcs.

OPEN
STOCK
40309

TRAY
PACK

OFF
SHELF

- Long microfiber super suds maker holds more soap & water
- Cleans like a mop without snagging on crevices
- Elastic cuff keeps mitt snug



45320 Microfiber Sudsmaker Long Chenille Wash Mitt

24
pcs.

OPEN
STOCK
45320

TRAY
PACK

OFF
SHELF

- Looks and feels like chenille yet performs like microfiber
- Convenient side for scrubbing
- Two mitts in one



40307 Microfiber Wash Mitt

24
pcs.

OPEN
STOCK
40307

TRAY
PACK

OFF
SHELF

- Suds maker super absorbent microfiber
- Lint, streak and scratch free cleaning
- Sponge lined for extra absorbency



40302 Chenille Wash Mitt

24
pcs.

OPEN
STOCK
40302

TRAY
PACK

OFF
SHELF

- Super suds deep pile chenille perfect for any surface
- Elastic cuff keeps mitt snug
- Plastic molded grip



40304 Chenille 2-in-1 Wash Mitt

24
pcs.

OPEN
STOCK
40304

TRAY
PACK

OFF
SHELF

- Super suds deep pile chenille perfect for any surface
- Elastic cuff keeps mitt snug
- Bug scrub netting



40306 Wool Wash Mitt

24
pcs.

OPEN
STOCK
40306

TRAY
PACK

OFF
SHELF

- Synthetic wool is extra soft and dense
- Great suds maker
- Elastic cuff keeps mitt snug



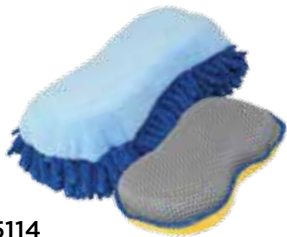

45114
Microfiber Sponge with Added Scrub

9 pcs.
 OPEN STOCK TRAY PACK OFF SHELF
 45114

- Large microfiber chenille pad for washing
- Two products in one
- Microfiber dog bone sponge has scrubbing mesh for bug and tar removal



40112
Microfiber 2-in-1 Long Chenille Sponge

24 pcs. 12 pcs.
 OPEN STOCK TRAY PACK OFF SHELF
 40112 40112PDQ

- Long microfiber super suds maker holds more soap and water
- Scrub side removes bug and tar from windows and mirrors
- Super absorbent sponge

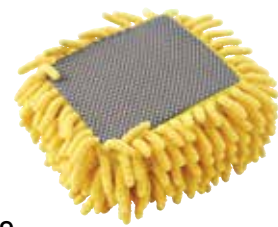

45119
Suds-N-Scrub Microfiber 2-in-1 Compact Wash Sponge

24 pcs.
 OPEN STOCK TRAY PACK OFF SHELF
 45119

- Extra long microfiber
- Compact size fits easily into palm
- Great suds maker



40110
Microfiber Bone Sponge

12 pcs.
 OPEN STOCK TRAY PACK OFF SHELF
 40110

- Sudsmaker super absorbent microfiber material
- Lint, streak and scratch free cleaning
- Super absorbent sponge



Multiple Parts Bone Sponge

12 pcs. 12 pcs.
 OPEN STOCK TRAY PACK OFF SHELF
 40102 40102D

- Extra absorbent and durable
- Bone shape is easy to hold
- Extra large sponge



40107
Chenille Sponge

12 pcs.
 OPEN STOCK TRAY PACK OFF SHELF
 40107

- Super suds deep pile chenille perfect for any surface
- Super absorbent sponge
- Safe on all surfaces



40106
Nylon Bug Sponge

12 pcs.
 OPEN STOCK TRAY PACK OFF SHELF
 40106

- Sponge with stiff netting safely scrubs bugs and tar from windows and mirrors
- Compact size fits easily into palm
- Extra absorbent

SPECIALTY SOLUTIONS LEADER

Material Selections and Innovations for Every Cleaning Tasks



40313
Microfiber 2-in-1 Wheel Detailer Wash Mitt

48 pcs.
 OPEN STOCK TRAY PACK OFF SHELF
 40313

- 2-in-1 microfiber detailer safely cleans painted and clear coated wheels
- 2-Sided microfiber pockets give cleaning power to fingers
- Microfiber reinforced scrub panel quickly cleans away brake dust and road grime



40314
2-Sided Microfiber Screen & Display Cleaner

24 pcs.
 OPEN STOCK TRAY PACK OFF SHELF
 40314

- 2-Sided for dash dusting and window and mirror defogging
- Pockets hold mitt to fingers to reach along window edges
- Suede for window with mirror and terry microfiber for dusting



45211
Deluxe Microfiber
Large Drying Towel (22" x 30")

24 pcs.
 OPEN STOCK TRAY PACK OFF SHELF
 45211

- Professional weave creates more drying sides and edges
- Super large, dries more area faster
- Lint & Streak free drying
- Cleans as it dries
- Safe on all surfaces



40061
3pk Microfiber Towels (16" x 16")

48 pcs. 25 pcs.
 OPEN STOCK TRAY PACK OFF SHELF
 40061 40061D

- Superior polishing, drying & detailing towel
 - Extra durable and lint free
 - Use for any car care task
- 40061 - 3pk Microfiber Towel (16" x 16")
 40061D - with tray pack, 25 pcs.



45070
Wash & Dry Microfiber Cloth (16" x 16")

12 pcs.
 OPEN STOCK TRAY PACK OFF SHELF
 45070

- Cleans without chemicals
- Absorbs 8 times its weight in water



Multiple Parts
Multi-Pack Microfiber Towels (14" x 14")

48/24 12 pcs.
 OPEN STOCK TRAY PACK OFF SHELF
 40062, 40062D 45067

- Superior polishing, drying & detailing towel
 - Extra durable and lint free
 - Use for any car care task
- 40062 - 8pk Towels, 48 pcs.
 45067 - 12pk Blue & Orange Towels, 24 pcs.



45062
2pk Microfiber Cloth (12" x 16")

12 pcs.
 OPEN STOCK TRAY PACK OFF SHELF
 45062

- Works like a magnet to attract & hold dust
- Great for dusting, windows and polishing
- Microfiber technology!



45069
Polishing & Wax Removal Cloth (16" x 16")

12 pcs.
 OPEN STOCK TRAY PACK OFF SHELF
 45069

- Removes streaks, haze, dust and wax residue

Optimizing Microfiber Value & Versatility

CLEAN • DRY • POLISH

ALL-IN ONE



45163
3pk Detailing Towels- Clean, Dry & Polish

24 pcs.
 OPEN STOCK TRAY PACK OFF SHELF
 45163

- **CLEANS:** Damp towel removes stain and residue
- **DRIES:** Super absorbent microfiber traps and holds water
- **POLISHES:** Safely and effectively removes wax and polish



45063
Microfiber Cloth (16" x 16")

12 pcs.
 OPEN STOCK TRAY PACK OFF SHELF
 45063

- Works like a magnet to attract & hold dust
- Great for dusting, windows and polishing
- Microfiber technology!



45066
Window & Dusting Cloth (12" x 16")

12 pcs.
 OPEN STOCK TRAY PACK OFF SHELF
 45066

- Lifts and locks dust within fabric
- Use wet or dry

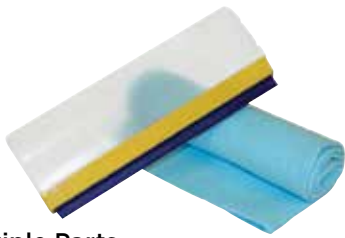

Multiple Parts
Evaporator PVA Drying Towel with Wipeout Blade Canister (3 sq. ft.)

24 pcs.
 OPEN STOCK TRAY PACK OFF SHELF
 40209, 40208

- Durable PVA towel with center mesh absorbs water like a sponge
 - Wipeout silicone blade removes water from body and window
 - Faster and better way to dry your car, truck, SUV or RV
- 40209** - with wipeout blade canister
40208 - Drying Towel



Multiple Parts
Synthetic Chamois

48 pcs.
 OPEN STOCK TRAY PACK OFF SHELF
 40211, 40210

- Streak and spot free drying
 - Requires less effort to dry all surfaces
 - Extra durable, easy to wring out and re-use
- 40211** - 3.5 sq. ft.
40210 - 2.5 sq. ft.



45010
Microfiber Max Drying Towel

36 pcs. **30** pcs.
 OPEN STOCK TRAY PACK OFF SHELF
 45010 45010D

- Textured design creates more drying surface
 - Lint & streak free drying
 - Super large (5 sq ft) dries large area fast
 - Cleans as it dries / Safe on all surfaces
- 45010** - Microfiber Max Drying Towel
45010D - with tray pack , 30 pcs.



40064
2pk Microfiber Glass Towels (12"x 16")

48 pcs.
 OPEN STOCK TRAY PACK OFF SHELF
 40064

- Use wet or dry for chemical free cleaning
- Keep inside car from fogging and removing smudge marks from dash
- Cleans without chemicals



40125
Microfiber Suede Towel (16"x 16")

48 pcs.
 OPEN STOCK TRAY PACK OFF SHELF
 40125

- Superior polishing towel easily removes wax and polish
- Removes haze and wax residue
- Safe on all surfaces



**First in Feature...
 Applicator Technology**

Patented ergonomic handle and fastening system changes the way wax, polish, and protectant are applied.

- 50% faster than hand waxing alone
- Keeps hands clean
- Universal, works on all applicator pads

Retail profits boost
30%
 where the gripper is placed.



45214
The Gripper™ 5pk Applicator Set with Reusable Canister (5")

6 pcs.
 OPEN STOCK TRAY PACK OFF SHELF
 45214

- Multi-purpose applicator pads with No mess handle
- 3 Microfiber applicators, 2 Terry applicators
- Ideal for interior and exterior uses



40123
The Gripper™ 2pk Microfiber Applicator Set (5")

24 pcs. **24** pcs.
 OPEN STOCK TRAY PACK OFF SHELF
 40123 40123D

- The Gripper handle holds tight to pad with fastening hooks
 - No-mess application of interior protectants and more
 - Completely reusable handle
- 40123** - 2pk Microfiber Applicator Set
40123D - with tray pack, 24 pcs.





40122
The Gripper™ 3pk Terry Applicator Set (5")

24
 pcs.

OPEN STOCK

40122

24
 pcs.

TRAY PACK

40122D

OFF SHELF

- The Gripper handle holds tight to pad with fastening hooks
- No mess application of wax and polish
- Completely reusable handle

40122 - 2pk Terry Applicator Set

40122D - with tray pack, 24 pcs.



Multiple Parts
Terry 5" Applicator Pads

48
 pcs.

OPEN STOCK

40118, 40119

TRAY PACK

40118, 40119

OFF SHELF

- Lint free, extra soft terry cloth
- Great for applying wax, polish and more
- Refills for The Gripper packs

40118 - 2pk Terry Applicator Pads

40119 - 4pk Terry Applicator Pads



40120
2pk Microfiber 5" Applicator Pads

48
 pcs.

OPEN STOCK

40120

TRAY PACK

40120

OFF SHELF

- Lint free and streak free
- Holds more protectant, polish and wax
- Extra absorbent and soft



POLISHING & DETAILING

Core and Essential Solutions for Complete Auto Care



Diaper Soft

Wax removal and exterior polishing



Cotton Terry

Cleaning & Drying



Cotton Flannel

Super soft polishing inside & out



Cotton Shop

Absorbing & clean up



40052
3pk Flannel Cloth (14" x 24")

48
 pcs.

OPEN STOCK

40052

TRAY PACK

40052

OFF SHELF

- Provides the ultimate high gloss shine
- Ultra soft and safe for all clear coats



Multiple Parts (11"x17")
Diaper Soft Polishing Cloths

See Below

OPEN STOCK

See Below

See Below

TRAY PACK

See Below

OFF SHELF

- Super soft for wax removal and polishing any surface
- Completely washable and reusable

40065 - 3pk rolled

40067 - 6pk rolled

40069 - 10pk bagged

40065D - with tray pack, 36 pcs.

40067D - with tray pack, 25 pcs.



Multiple Parts
Cotton Terry Towels (14" x 17")

See Below

OPEN STOCK

See Below

30
 pcs.

TRAY PACK

40050D

OFF SHELF

- Dries and details
- Completely washable and reusable
- Hemmed for extra durability

40050 - 3pk rolled

40051 - 12pk bagged

45054 - 4pk bagged



Multiple Parts
Shop Towels (13" x 14")

48
 pcs.

OPEN STOCK

See Right

36/20
 pcs.

TRAY PACK

See Right

OFF SHELF

- Completely washable and reusable
- Perfect general purpose shop towel
- Soft and absorbent for hands, tools and more

40046 - 5pk rolled

40047 - 10pk rolled

40048 - 25pk bagged

40046D - with tray pack, 36 pcs.

40047D - with tray pack, 20 pcs.

40071
1/2lb Bag of Rags

24
 pcs.

OPEN STOCK

40071

TRAY PACK

40071

OFF SHELF

- Soft, washable and absorbent
- Perfect for all purpose clean up
- Perfect for auto, home, marine & shop use





DUST & DRY PRODUCTS

Dust & Dry to a Showroom Shine...

- Industry leading West Coast dusting technology
- Cleans and shines in one simple step
- Premium soft cotton fibers



Quickly Lifts Dust from All Vehicle Areas



- Patent Pending hybrid drying blade design
- Dries and details in one device
- Speeds drying, minimizes drips and eliminates water spots



- The easiest way to dry your car, truck, or SUV!
- Spot, lint, and streak-free drying



Multiple Parts Pacific Coast Professional Car Duster

24 pcs.

OPEN STOCK TRAY PACK OFF SHELF

93008PC, 93007

- Specially treated fibers lift dust and dirt, will not scratch paint
 - Long handle for added reach
 - Storage bag included
- 93008PC - with Wood Handle
93007 - with Plastic Handle



93006 Pacific Coast Dash Duster

24 pcs.

OPEN STOCK TRAY PACK OFF SHELF

93006

- Specially treated fibers lift dust and dirt, will not scratch paint
- Use for auto, home and more
- Safe on all surfaces



45617AS Pacific Coast Bead-Blade™

16 pcs.

OPEN STOCK TRAY PACK OFF SHELF

45617AS

- Patented 2-Sided hybrid drying blade
- Complete vehicle drying, minimizes drips and eliminates water spots



45218 Pacific Coast Drying Towel™

6 pcs.

OPEN STOCK TRAY PACK OFF SHELF

45218

- Premium synthetic towel in reusable canister
- The easiest way to dry your vehicle
- Also great for household, marine and drying pets





#1 Name In Glass Care ... Everywhere

Innovative Glass Care Accessories Make Each Cleaning Task Easier

... are designed to handle all glass, mirror, and optical cleaning jobs for your car, truck, SUV or RV. Compact and convenient; use them at home, on the go, on their own - or with your favorite Rain-X® cleaning liquids for a truly flawless result. With solutions for washing, drying, dusting, polishing, and defogging; the Rain-X® Glass Cleaning and Care Accessory line —

Lets You See Clearly ... inside & out!

The Most Trusted Name In Glass Care



Images of Rain-X® chemicals are used with permission of Illinois Tool Works, Inc. and are not sold or distributed by Hopkins Mfg.

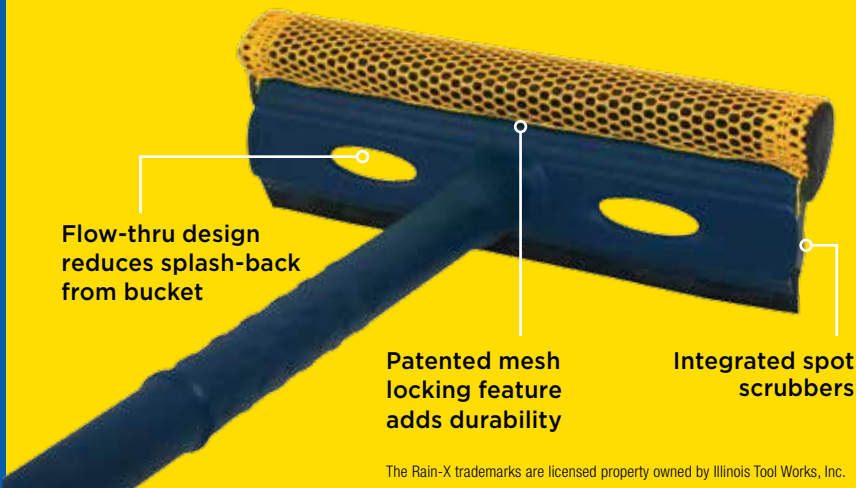

The Rain-X trademarks are licensed property owned by Illinois Tool Works, Inc.



9271X
8" Squeegee
with 39" Extension

6 pcs.

OPEN STOCK TRAY PACK OFF SHELF

9271X

- Flow-thru design reduces splash-back from bucket
- Integrated spot scrubbers
- Patented mesh locking feature adds durability



9425CDX
Liquid-Filled
8" Spray Squeegee

12 pcs.

12 pcs.

OPEN STOCK TRAY PACK

9425CDX 9425CDX

- Tough scrub netting
- Side mount scrubber
- Refillable, easy pump spray



9438X
Compact 8" Squeegee

8 pcs.

8 pcs.

OPEN STOCK TRAY PACK

9438X 9438X

- Handle extends to 15" and collapses to store
- Compact design stores anywhere
- Double scrubbing action



9272X
Premium 8" Squeegee w/20" Handle Gas Station Squeegee

6 pcs.

OPEN STOCK TRAY PACK OFF SHELF

9272X

- Patented "double-wrap" scrub assist netting
- Patented mesh locking system has greater pull prolonging product life
- Exclusive Water-Shed™ head design minimizes splash back and reduces fatigue



Swiper

Drying Mitt™

- Built-in soft squeegee blades
- Plush microfiber for detailing, drying, & polishing
- Safe on all surfaces Auto, Truck, SUV, RV & Home

45137X Swiper Drying Mitt™



See The Swiper
Drying Mitt™
in Action



45544X Triple Blade Glass Tool

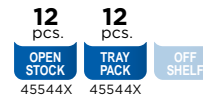

- Removes bugs and debris
- Swipes clean wiper blades
- Lifts labels & decals. Works on all glass, mirror, and optical cleaning jobs

Integrated
Scrubbing Dots

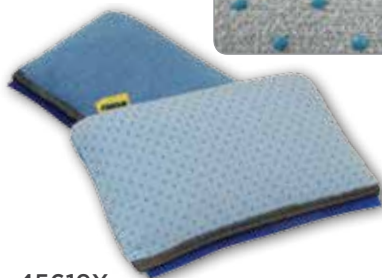

45619X 3-in-1 Window Blade



- Premium terry microfiber removes fingerprints and window haze
- Soft suede microfiber cleaning with scrub dots
- Sof-Tools™ flexible squeegee quickly removes morning mist and dries all exterior windows. Works on all glass and mirror surfaces



45116X 2-Sided Microfiber Defogger Sponge

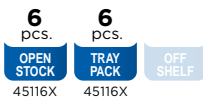

- Compact microfiber sponge is ideal for quick dash cleaning and window defogging
- Gray terry microfiber quickly cleans glass screen & optical surfaces
- Yellow soft suede microfiber removes fingerprints and window haze
- Square shape reaches tight corners and mirror surfaces



45078X Microfiber Window Mate

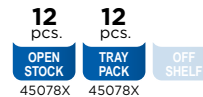

- Defogs and cleans glass & mirror surfaces
- Premium microfiber chenille
- Works on all glass, mirror, and optical cleaning jobs



45122X 2-Sided Bug & Tar Sponge



- Gray, heavy mesh is ideal for body, bumper, and wheel scrubbing
- Blue mesh works great on glass, headlights, and optics



Leverage Rain-X® brand equity to promote and cross-sell in your planogram



Quality Since 1900

For more than a century, Mallory has designed and manufactured innovative DIY products. Over the years Mallory developed the market leading position in the automotive window squeegee category where we have the #1 position in North America.

Mallory's innovative automotive squeegee range gives Hopkins the widest assortment of glass care tools available to service all of your shoppers needs.

Widest Assortment of Squeegees And Glass Care Tools Available



9025CDF Window Wash Spray Squeegee

12 pcs.

OPEN STOCK

TRAY PACK

OFF SHELF

9025CDF

- Refillable, easy pump spray
- Side mount scraper



9038 8" Compact Squeegee with Folding Handle

48 pcs.

OPEN STOCK

TRAY PACK

OFF SHELF

9038

- Handle extends to use and collapses to store
- Compact design stores anywhere
- Double scrubbing action



806NY 6" red plastic head with 9" handle

6 pcs.

OPEN STOCK

TRAY PACK

OFF SHELF

806NY

- Heavy-Duty plastic handle with rubber blade
- Foam with scrub netting



9020A "Misty" Squeegee 6" acrylic plastic squeegee with netting

12 pcs.

OPEN STOCK

TRAY PACK

OFF SHELF

9020A

- Heavy-Duty plastic handle with rubber blade
- Foam with scrub netting



Multiple Parts Squeegee Bucket with Steel Bracket (Black)

See Below

OPEN STOCK

TRAY PACK

OFF SHELF

- Sturdy molded plastic
- Ideal for service station island



885 - 2 Gallon Squeegee Bucket with Bracket, 1 pc.



94101 - 1 Gallon Squeegee Bucket with Bracket, 18 pcs.



Multiple Parts 10" Professional Metal Squeegee w/ Ext. Pole

See Below

OPEN STOCK

TRAY PACK

OFF SHELF

- Rust resistant, EPDM pliable blade, bug scrub netting
- Plastic side guards protects glass
- Adjustable handle

Brand	Part #	Description
Mallory	4-10NY-E	Professional 10" squeegee head with 49"- 7.5' aluminum telescopic handle (unassembled), 4pk
Carrand	9500	10" squeegee with 48"- 7' extendable handle (assembled), 6pk



Multiple Parts 8" Professional Metal Squeegee w/ Ext. Pole

See Below

OPEN STOCK

TRAY PACK

OFF SHELF

- Rust resistant, EPDM pliable blade, bug scrub netting
- Plastic side guards protects glass
- Adjustable handle

Brand	Part #	Description
Mallory	8NYE-48	Pro 8" squeegee head w/ 48" aluminum telescopic handle, 12pk
Carrand	9049	Deluxe 8" squeegee w/ 42" ext. handle (steel), 24pk
Carrand	9045R	8" squeegee w/ 42" ext. handle (steel), 24pk





Multiple Parts
Deluxe 8" Metal Professional Head with Wood Handle, assembled

See Below
 OPEN STOCK TRAY PACK OFF SHELF

- Rust resistant, EPDM pliable blade, bug scrub netting
- Plastic side guards protects glass

Brand	Part #	Description
Mallory	8NY-16A	Pro 8" squeegee head with 15" handle, red, 24pk
Mallory	8NY-24A	Pro 8" squeegee head w/24" handle, red, 12pk
Mallory	24-808NY-30A	Pro 8" squeegee head w/30" handle, red, 24pk
Carrand	9056	Deluxe 8" squeegee with 12" handle, black, 24pk
Carrand	9057	Deluxe 8" squeegee with 20" handle, black, 24pk
Carrand	9031R	8" squeegee with 12" handle, red, 24pk
Carrand	9032R	8" squeegee with 20" handle, red, 24pk



Multiple Parts
Deluxe Plastic Professional Squeegee with Extendable Handle, assembled

See Below
 OPEN STOCK TRAY PACK OFF SHELF

- EPDM Blade, nylon net, heavy-duty sponge
- Adjustable handle

Brand	Part #	Description
Mallory	WSE-39A	Pro 8" squeegee head with 24"- 39" aluminum ext. handle, 8pk
Carrand	9046	8" plastic head with 27"-42" steel ext. handle, 24pk



Multiple Parts
Deluxe 10" Metal Professional Head with Wood Handle, assembled

See Below
 OPEN STOCK TRAY PACK OFF SHELF

- Rust resistant, pliable blade, bug scrub netting
- Plastic side guards protects glass

Brand	Part #	Description
Mallory	10NY-24A	Pro 10" squeegee head with 20" handle, red, 12pk
Carrand	9058	Deluxe 10" squeegee with 20" handle, black, 24pk
Carrand	9037R	10" squeegee with 20" handle, red, 24pk



Multiple Parts
Deluxe Plastic Professional Squeegee with Solid Plastic Handle, assembled

See Below
 OPEN STOCK TRAY PACK OFF SHELF

- EPDM Blade, nylon net, heavy-duty sponge
- Perma-net locking system; Double wrap netting

Brand	Part #	Description
Mallory	WS1524A	Pro 8" squeegee head with 15" handle, 24pk
Mallory	WS2024A	Pro 8" squeegee head with 20" handle, 24pk
Carrand	9266	8" squeegee head with 15" handle, 24pk
Carrand	9267	8" squeegee head with 20" handle, 24pk

UNASSEMBLED SQUEEGEE

Deluxe Metal Professional

Brand	Part #	Description
Mallory	12-8NY-48	Professional 8" squeegee / 48" hardwood handle, 24pk
Mallory	4-10NY-E	Professional 10" squeegee / 7' aluminum telescopic handle, 4pk
Carrand	9053	8" Deluxe steel head / 20" Wood Handle, black, 12pk
Carrand	9039R	10" Deluxe metal head / 20" Wood Handle, red, 12pk
Carrand	9010R	8" metal head / 20" Wood Handle, red, 12pk
Carrand	9014R	8" metal head / 12" Wood Handle, red, 12pk



Deluxe Plastic Professional

Mallory	WS1524U	8" professional head, 15" plastic handle, 24pk
Mallory	WS2024U	8" head, 20" plastic handle, 24pk
Mallory	WS4224U	8" head, 42" aluminum handle, 24pk
Carrand	9262	8" head / 15" plastic handle, 12pk
Carrand	9262B	"Professional Squeegee in a Bag", 8" head / 15" plastic handle in sealed bag, 12pk
Carrand	9263	8" plastic head / 20" plastic handle, 12pk





BULK SQUEEGEES

Unassembled Squeegee Parts

BULK SQUEEGEE HEADS

Metal (Steel) Professional

Mallory	12-808NY	8" professional squeegee head
Mallory	12-810NY	10" professional squeegee head
Carrand	9050	8" deluxe squeegee head
Carrand	9051	10" deluxe squeegee head
Carrand	9000R	8" metal head
Carrand	9033R	10" metal head



Plastic Professional

Mallory	WSH24	8" professional plastic head, black
Carrand	9260	8" plastic head, black

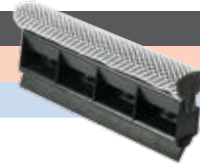

BULK SQUEEGEE HANDLES

Brand	Part #	Description
Mallory	110	12" professional threaded hardwood handle
Mallory	111	20" professional threaded hardwood handle
Mallory	112U	30" professional threaded hardwood handle
Mallory	148	48" professional hardwood handle
Carrand	9008BLK	20" wood handle, black
Carrand	9003R	12" Wood Handle, Red
Carrand	9005R	20" Wood Handle Red
Carrand	9007R	32" Wood Handle Red
Mallory	WS1524	15" professional solid, heavy-duty, plastic handle, black
Mallory	WS2024	20" professional solid, heavy-duty, plastic handle, black
Mallory	WS4212	42" professional heavy-duty, aluminum handle
Carrand	9217Blk	15" Plastic Handle, Black
Carrand	9221Blk	20" Plastic Handle, Black



FIBERGLASS, METAL, WOOD HANDLES - BULK

Carrand	92508	Fiberglass Ext. Pole w/ Metal Tip - 4-8 ft. (non flow-thru)
Carrand	92509	Fiberglass Ext. Pole w/ Metal Tip - 6-12 ft. (non flow-thru)
Carrand	92510	Fiberglass Pole w/ Metal Tip - 15-16" x 6 ft. (non flow-thru)
Carrand	92511	Fiberglass Ext. Pole w/ Metal Tip - 5-10 ft. (non flow-thru)
Mallory	115-4	Professional 48 1/2" aluminum extended, 2 sections, external lock, combo acme thread and cone adapter, 29" collapsed
Mallory	115-6	Professional 72 3/4" aluminum extended, 2 sections, external lock, combo acme thread and cone adapter, 40 5/8" collapsed
Mallory	115-8	Professional 96" aluminum extended, 2 sections, external lock, combo acme thread and cone adapter, 53" collapsed
Carrand	9501	48"-84" aluminum extension handle
Carrand	9507	53" - 96" Aluminum Ext. Hdle w/ Reinforced Tip
Carrand	9508	27" - 46" Steel Ext. Hdle w/ Reinforced Tip, black powder coat
Carrand	9514	H.D. Alum. Flow-Thru Ext. Hdle w/ Slide water control, up to 67"
Mallory	116	Professional 54" hardwood handle
Mallory	160	Professional 60" threaded hardwood handle - natural finish
Mallory	118-54	Professional 54" threaded aluminum handle w/grip
Carrand	93069	60" Handle (15/16") w/ Metal Tip, acme thread
Carrand	93501	60" handle, 1" Diameter Wood Pole Sanded, Tapered, threaded
Carrand	93502	1 1/8" x 72" Wood Pole w/ Metal Tip, acme thread
Carrand	93504	60" handle, 1" Diameter wood pole with Thread, Laquered





MERCHANDISING MENU

- OPEN STOCK
- TRAY PACK
- OFF SHELF
- SIDE KICK
- FLOOR DISPLAY

TRAY PACK

TRAY PACKS

Part #	Description	# Pcs.
92036D	Deluxe Tire & Bumper Brush	16 pcs.
92012D	Deluxe Wheel & Brake Dust Brush	24 pcs.
92010D	Deluxe Double Loop Wheel Brush	24 pcs.
93025D	Body Brush	16 pcs.
92017D	2-in-1 Microfiber Wheel Detailer	24 pcs.
93036D	Tire & Bumper Brush	16 pcs.
90051D	Fire Hose Nozzle with On/Off	24 pcs.
90049D	Fire Hose Nozzle	24 pcs.
9025CDF	Window Wash Spray Squeegee	12 pcs.
40112D	Microfiber 2-in-1 Long Chenille Sponge	12 pcs.
40062D	8pk Microfiber Towels (14" x 14")	12 pcs.
40061D	3pk Microfiber Towels (16" x 16")	25 pcs.
40123D	2pk Gripper Microfiber Applicator Set	24 pcs.
40122D	3pk Gripper Terry Applicator Set	24 pcs.
40050D	3pk Cotton Terry Towels (14" x 17")	30 pcs.
40065D	3pk Diaper Soft Polishing Cloths (11" x 17")	36 pcs.
40067D	6pk Diaper Soft Polishing Cloths (11" x 17")	25 pcs.
40046D	5pk Shop Towels (13" x 14")	36 pcs.
40047D	10pk Shop Towels (13" x 14")	20 pcs.
45544X	Triple Blade Glass Tool	12 pcs.
45116X	2-Sided Microfiber Defogger Sponge	6 pcs.
45078X	Microfiber Window Mate	12 pcs.
9425CDX	Liquid-Filled 8" Spray Squeegee	12 pcs.
9438X	Compact 8" Squeegee	8 pcs.



OFF SHELF

OFF SHELF

Part #	Description	# Pcs.
92019WR	Lug Nut Brush with Wire Basket	12 pcs.
92046WR	Interior/Exterior Detail Brush with Wire Basket	24 pcs.
93043WR	Vent Brush with Wire Basket	24 pcs.
92047WR	Finger Loop Scrub Brush with Wire Basket	12 pcs.
92043WR	Contour Tire Wipe with Wire Basket	12 pcs.



FLOOR DISPLAY

FLOOR DISPLAY

Part #	Description	# Pcs.
93984D	10" Suds-N-Go Bi-Level Wash Brush with 68" Extension Pole	12 pcs.
93097D	10" Bi-Level Wash Brush with 68" Extension Pole	12 pcs.
93089D	10" Wash Brush with 68" Extension Pole	12 pcs.
93060D	8" Bi-Level Wash Brush with 48" Pole	12 pcs.
93062D	10" Wash Brush with 65" Extension Pole	12 pcs.
93058D	10" Wash Brush with 48" Handle	12 pcs.
92215D	Wash-Jet Power Wand	12 pcs.
92216D	Wash-Jet Power Wand with Microfiber Wash Pad	12 pcs.
92217D	Wash-Jet Power Wand with 3-Way Adjustable Nozzle	12 pcs.
96100	Automotive Appearance Rack Prepack	174 pcs.
93072D	10" All-sided Flow-Thru Wash Brush	12 pcs.
93053D	8" Heavy-duty Wash Brush	12 pcs.
93303D	Microfiber Chenille Wash Mop with 48" Extension Pole	12 pcs.





GO SMARTER

Innovating Life On-The-Go

GoGear® delivers functional solutions that consumers need, from protection against the elements to organizing their mobile life.

Superior Product Performance

Durable, high quality materials and rugged design mean GoGear products provide better performance, fit and organization.

Excellent Value

Built to rigorous standards, GoGear may cost a little more but you are investing in more satisfied customers.



One Size Doesn't Work for All ...

49% of Your Floor Mat Shoppers Agree



Your Market Basket is Leaking

- Universal “Car” mats leak sales to lower and middle price points
- Truck, SUV & Crossover sales are being lost to the direct-to-consumer channel for fit and protection



Create a Truck, SUV & Crossover Shopper Destination

- GoGear® Floor Mats address the three main concerns of these shoppers: Fit, Protection and Security



Achieve a Win/Win

- Capture higher growth
- Plug leaks to lower price points
- Gain more satisfied shoppers
- Grow sales and increase profits



NEW

FULL-SIZE & MID-SIZE

HEAVY-DUTY TRUCK/SUV/CROSSOVER FLOOR MATS

Green hook screams
"I'm different!"



BETTER SHOPABILITY

Packaging speaks to the top priorities of Truck/SUV/Crossover Owners:

BETTER FIT

- Vehicle makes/models listed on packaging guide the consumer to the correct size, for a confident fit
- Achieve an Exact Fit using easy trim guides
- Red packaging is for full-size vehicles, blue is for mid-size

MORE PROTECTION

Packaging shouts interior protection:

- Heavy-Duty
- Ultimate Protection
- Tougher Mats For Tougher Demands

ADDED SECURITY

Multi-Point Locking™ reassures shoppers that the mat will hold securely and stay in place, for superior protection and safety

NEW HEAVY-DUTY TRUCK/SUV/CROSSOVER FLOOR MATS

49% of today's consumers drive Trucks, SUVs or Crossover vehicles. "One-size-fits-all" car mats designed in the 1970s fail to provide the heavy-duty durability, fit, and interior protection demanded by today's consumers.

GoGear® floor mats are engineered for Truck, SUV, and Crossover interiors, meeting tough demands for interior protection.

Available in 3 Colors

Black, Beige and Gray

ANATOMY OF SUPERIOR INTERIOR PROTECTION

1

Easy-Trim Guides

Provides a superior fit when compared to other retail products on the market

2

Double-Layer Heel Guard

provides up to 57% more protection where mats endure the most wear

3

Elevated Footrail

Protects your carpet better from debris

ULTIMATE PROTECTION™

Tougher Mats for Tougher Demands™



Rear Flex Mat™

Lets consumers choose the option that provides the best interior protection for their vehicle



Separate rear twin mats or full-across runner

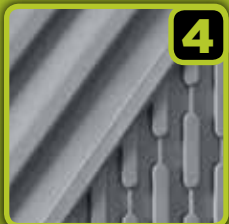

4

Deep Channel Basin

Holds up to 47% more snow, ice, mud and debris than similarly priced floor mats



5

Premium Lockdown

Up to 3X the holding power of the competition, for a safer mat



Spike-style anchors at the top keep your mat from rolling back onto pedals



Cleat-style anchors filling out the rest of the mat prevent forward sliding



A premium **hook & loop** feature built into every GoGear driver side mat for added safety

NEW Full-Size Floor Mats

Truck & SUV



4 Piece Sets Driver side and Passenger side mats with Rear Flex Mat™ (see page 43 for details)

Black Full-Size Floor Mats 4 pc.

4 sets
OPEN STOCK

79000

16 sets
FLOOR DISPLAY

See Page 55

Gray Full-Size Floor Mats 4 pc.

4 sets
OPEN STOCK

79001

16 sets
FLOOR DISPLAY

See Page 55

Beige Full-Size Floor Mats 4 pc.

4 sets
OPEN STOCK

79002

16 sets
FLOOR DISPLAY

See Page 55



2 Piece Sets Driver side and Passenger side mats

Black Full-Size Floor Mats 2 pc.

4 sets
OPEN STOCK

79040

16 sets
FLOOR DISPLAY

See Page 55

Gray Full-Size Floor Mats 2 pc.

4 sets
OPEN STOCK

79041

16 sets
FLOOR DISPLAY

See Page 55

Beige Full-Size Floor Mats 2 pc.

4 sets
OPEN STOCK

79042

16 sets
FLOOR DISPLAY

See Page 55

Full-Size Floor Mats Recommended for ...

BUICK Enclave / CADILLAC Escalade / CHEVROLET Avalanche, Silverado, Suburban, Tahoe, Traverse / DODGE Ram, Durango / FORD Expedition, F-Series / GMC Acadia, Sierra, Yukon / HONDA Ridgeline, Pilot / LINCOLN/MERCURY MKT, Navigator / MAZDA CX-9 / NISSAN Armada, Titan / TOYOTA Land Cruiser, Sequoia, Tundra



NEW Mid-Size Floor Mats

Truck/SUV/Crossover



4 Piece Sets Driver side and Passenger side mats with Rear Flex Mat™ (see page 43 for details)

Black Mid-Size Floor Mats 4 pc.

4 sets
OPEN STOCK
79100

16 sets
FLOOR DISPLAY
See Page 55

Gray Mid-Size Floor Mats 4 pc.

4 sets
OPEN STOCK
79101

16 sets
FLOOR DISPLAY
See Page 55

Beige Mid-Size Floor Mats 4 pc.

4 sets
OPEN STOCK
79102

16 sets
FLOOR DISPLAY
See Page 55



2 Piece Sets Driver side and Passenger side mats

Black Mid-Size Floor Mats 2 pc.

4 sets
OPEN STOCK
79140

16 sets
FLOOR DISPLAY
See Page 55

Gray Mid-Size Floor Mats 2 pc.

4 sets
OPEN STOCK
79141

16 sets
FLOOR DISPLAY
See Page 55

Beige Mid-Size Floor Mats 2 pc.

4 sets
OPEN STOCK
79142

16 sets
FLOOR DISPLAY
See Page 55

Mid-Size Floor Mats Recommended for ...

BUICK Encore / CADILLAC SRX / CHEVROLET Colorado, Equinox / DODGE Dakota, Journey, Nitro / FORD Edge, Escape, Explorer, Ranger, Sport Trac / GMC Canyon, Terrain / HONDA CR-V, Element / NISSAN Cube, Frontier, Pathfinder, Rogue, Xterra / HYUNDAI Santa Fe, Tucson, Veracruz / KIA Borrego, Sorento, Soul, Sportage / LINCOLN/MERCURY Mariner, MKX, Mountaineer / MAZDA CX-5, CX-7, Tribute / MITSUBISHI Endeavor, Outlander / SUBARU Forester, Outback, Tribeca / SUZUKI Equator, Grand Vitara / TOYOTA 4-Runner, Highlander, Scion, RAV4, Tacoma

GOORGANIZED

GoGear continues to take soft-side organization to new heights with designs and features that complement your shoppers' vehicles. Premium features are built right in: Magnetic ClickLock™ closures for easy one handed use, rugged Ny-Max™ accent materials and upscale stitching produce a durable product with luxury vehicle styling.



10" H
9" W
15" D

CENTER-BLA Center Seat Organizer™

3 pcs.

OPEN STOCK TRAY PACK CLIP STRIP SIDE KICK FLOOR DISPLAY

CENTER-BLA

- Removable beverage cooler holds nine 12 ounce cans
- Multiple pockets and divided storage
- Magnetic lid keeps items out of view



14.5" H
12.5" W
7.5" D

TOWER-BLA Tower Organizer™

3 pcs.

OPEN STOCK TRAY PACK CLIP STRIP SIDE KICK FLOOR DISPLAY

TOWER-BLA

- Space-saving two-level storage provides quick and easy access
- Multiple pockets and divided storage
- Magnetic lid keeps items out of view



5" H
11.5" W
11" D

CNSLPLUS-BLA Console Plus Organizer™

3 pcs.

OPEN STOCK TRAY PACK CLIP STRIP SIDE KICK FLOOR DISPLAY

CNSLPLUS-BLA

- Unique mobile phone landing pad
- Multiple pockets and divided storage
- Magnetic lid keeps items out of view



5" H
11.5" W
9.5" D

CMPTPLUS-BLA Compact Plus Organizer™

3 pcs.

OPEN STOCK TRAY PACK CLIP STRIP SIDE KICK FLOOR DISPLAY

CMPTPLUS-BLA

- Magnetic covered storage conceals valuables
- Keep your vehicle clutter free
- Perfect for the value minded customer



5.75" H
9" W
4" D

MINIORG Mini Organizer™

3 pcs.

OPEN STOCK TRAY PACK CLIP STRIP SIDE KICK FLOOR DISPLAY

MINIORG

- Adaptable: Slide into or between seats
- Removable divider to customize your storage areas
- Stores easily under your seat when not in use



14.5" H
14.5" W
1.5" D

BACKPLUS-BLA Back of Seat Plus Organizer™

3 pcs.

OPEN STOCK TRAY PACK CLIP STRIP SIDE KICK FLOOR DISPLAY

BACKPLUS-BLA

- Hangs from any vehicle head rest
- Five large pockets for activities and other necessities
- Great for vehicles with limited space



BACKORG
Back of Seat Organizer™

16.5" H
14.5" W
.25" D

3 pcs.

- OPEN STOCK
- TRAY PACK
- CLIP STRIP
- SIDE KICK
- FLOOR DISPLAY

BACKORG

- Mesh pockets keep items neatly organized and accessible
- Tool straps keep tools handy
- Umbrella holder for wet weather



UNDERORG
Underseat Organizer™

4.5" H
10" W
11" D

3 pcs.

- OPEN STOCK
- TRAY PACK
- CLIP STRIP
- SIDE KICK
- FLOOR DISPLAY

UNDERORG

- Designed to fit underneath most seats
- Convenient straps organize small vehicle tools
- Exterior pockets for visibility and easy access



CARGO-BLA-2
Trunk Organizer

8.5" H
13.5" W
12.5" D

3 pcs.

- OPEN STOCK
- TRAY PACK
- CLIP STRIP
- SIDE KICK
- FLOOR DISPLAY

CARGO-BLA-2

- Keeps smaller trunks or cargo areas organized
- Removable divider for customization
- Sturdy Ny-Max™ material stands up to heavy consumer use

DRAMATIC SHELF IMPACT

Engage consumers with fresh, compelling packaging and vibrant GoGear® branding



TRU-BLA-PDQ
Storagemaster®
Cargo Organizer™

12" H
43" W
9" D

3 pcs.

- OPEN STOCK
- TRAY PACK
- CLIP STRIP
- SIDE KICK
- FLOOR DISPLAY

TRU-BLA-PDQ

- Organize your trunk or cargo area with three segmented compartments
- Sturdy frame, supported by durable steel tubing and heavy-duty netting
- Length adjusts from 37" to 43" and folds out of the way when not in use

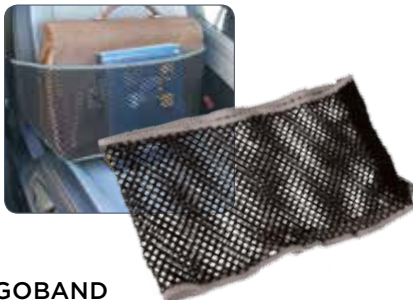

GOBAND
GoBand™ Seat Organizer

6 pcs.

- OPEN STOCK
- TRAY PACK
- CLIP STRIP
- SIDE KICK
- FLOOR DISPLAY

GOBAND

- Quick convenience at your fingertips
- Prevents items from spilling or rolling while driving or stopping suddenly
- Easily slides out of the way for passenger



VENT-05
Vent Pack Organizer

6 pcs.

6 pcs.

18 pcs.

- OPEN STOCK
- TRAY PACK
- CLIP STRIP
- SIDE KICK
- FLOOR DISPLAY

VENT-05

VENT-05 CS

VENT-05 SK

- Durable netting allows you to see inside the organizer
- Adjustable clip fits almost any vent
- Easy to move, simple to use



VENT-10
Vent Pack XL Organizer

6 pcs.

6 pcs.

18 pcs.

- OPEN STOCK
- TRAY PACK
- CLIP STRIP
- SIDE KICK
- FLOOR DISPLAY

VENT-10

VENT-10 CS

VENT-10 SK

- Large enough for a smartphone or MP3 player
- Bonus front pocket sized to fit slim cell phones
- Adjustable clip fits almost any vent

GO TRADITIONAL FOR COMPLEMENTARY SALES

Traditional organizers continue to see strong sales, especially when merchandised alongside new soft-sided organizers. Most feature adjustable drink holders that lock in place, securing everything from coffee mugs to oversized beverages. Choose your style: open storage or closed compartments to best suit your consumers' needs.



9" H
13.5" W
14.5" D

BLA **CHA**
Black Charcoal

SSC-BLA/DLX, SSC-CHA/DLX Bench/Rear Seat Deluxe Console

1
pc.

OPEN STOCK TRAY PACK CLIP STRIP SIDE KICK FLOOR DISPLAY

SSC

- Includes added features: overmolded lid, trash can, retail display box
- Segmented organization areas for CDs, tissue, cell phone, coins
- Two adjustable locking drink holders secure drinks from 6 to 64 oz.



9" H
10.5" W
14.5" D

BLA **CHA**
Black Charcoal

BENCH-BLA, BENCH-CHA Bench Console

1
pc.

OPEN STOCK TRAY PACK CLIP STRIP SIDE KICK FLOOR DISPLAY

BENCH

- Stores CDs and travel items
- Small compartments to dispense tissues, segment coins and hold small items
- Two adjustable locking holders secure drinks from 6 to 64 oz.



6" H
9.5" W
13.5" D

BLA **CHA**
Black Charcoal

SC-BLA, SC-CHA Seat Console

2
pcs.

2
pcs.

OPEN STOCK TRAY PACK CLIP STRIP SIDE KICK FLOOR DISPLAY

SC

SEE PAGE 54

- Designed to mount to floors, humps or seats
- Includes storage for CDs, pens, and coins
- Two adjustable locking drink holders accommodate most size drinks



4.5" H
9.5" W
9.5" D

BLA **CHA**
Black Charcoal

EMIC-BLA, EMIC-CHA Mini Console

3
pcs.

3
pcs.

OPEN STOCK TRAY PACK CLIP STRIP SIDE KICK FLOOR DISPLAY

EMIC SEE PAGE 54

- Designed for efficient organization
- Storage for coins and CDs
- Two adjustable locking drink holders accommodate most size drinks



4" H
8" W
13" D

BLA **CHA**
Black Charcoal

EFF-BLA, EFF-CHA Efficiency Console

5
pcs.

5
pcs.

OPEN STOCK TRAY PACK CLIP STRIP SIDE KICK FLOOR DISPLAY

EFF

SEE PAGE 54

- Economy console stores common travel items
- Storage for coins and CDs
- Two drink holders hold small to medium sized drinks



SMT
Twin Cupholder

- 6 pcs.
- OPEN STOCK
- TRAY PACK
- CLIP STRIP
- SIDE KICK
- FLOOR DISPLAY

- Includes two adjustable drink holders and a convenient personal organizer
- Unit mounts easily and securely to console, armrest or floor
- Console strap included



RETRO-CHA
Retro-Fit Cupholder

- 6 pcs.
- OPEN STOCK
- TRAY PACK
- CLIP STRIP
- SIDE KICK
- FLOOR DISPLAY

- Designed to instantly convert built-in cupholders to adjustable locking drink holders
- Securely holds drinks from 6 to 64 oz.
- Ideal for any vehicle



SEJ
Compact Cupholder

- 6 pcs.
- OPEN STOCK
- TRAY PACK
- CLIP STRIP
- SIDE KICK
- FLOOR DISPLAY

- Ideal for compact spaces
- Single drink holder adjusts to fit drinks from 6 to 32 oz.
- Mounts easily to armrest, console or floor

BONUS CLIP



VSR-20
Visor Organizer™:
20 Discs + Sun Visor

- 6 pcs.
- OPEN STOCK
- TRAY PACK
- CLIP STRIP
- SIDE KICK
- FLOOR DISPLAY

- Unique fold-out sun visor blocks the sun from the left and the front
- Two-sided storage space for 20 discs
- Bonus sunglasses clip included



VSR-10
Visor Organizer™: 10 Discs

- 6 pcs.
- OPEN STOCK
- TRAY PACK
- CLIP STRIP
- SIDE KICK
- FLOOR DISPLAY

- Storage space for 10 discs
- All-purpose pocket and pen holder
- Durable Ny-Max material stands up to the toughest demands



VSR
Visor Organizer™

- 6 pcs.
- OPEN STOCK
- TRAY PACK
- CLIP STRIP
- SIDE KICK
- FLOOR DISPLAY

- Storage space for MP3 Player
- All-purpose pocket and pen holder
- Durable Ny-Max material stands up to the toughest demands



TRASH-BLA
Pop-Up Trash Can™

- 6 pcs.
- OPEN STOCK
- TRAY PACK
- CLIP STRIP
- SIDE KICK
- FLOOR DISPLAY

- Pops up to use, collapses down to store
- Treated liner helps contain spills and cleans easily
- Special tab on bottom keeps can from tipping and rolling

8" H
6" W
6" D



TRASH13-BLA-PDQ
Tall Pop-Up Trash Can™

- 6 pcs.
- OPEN STOCK
- TRAY PACK
- CLIP STRIP
- SIDE KICK
- FLOOR DISPLAY

- Pops up to use, collapses down to store
- Treated liner helps contain spills and cleans easily
- Special tab on bottom keeps can from tipping and rolling

13" H
9.5" W
9.5" D



TRASH10-BLA
Space Saver Trash Can™

- 6 pcs.
- OPEN STOCK
- TRAY PACK
- CLIP STRIP
- SIDE KICK
- FLOOR DISPLAY

- Slim design utilizes vehicle space more efficiently
- Attaches to console, door, gear shift or seat pocket

Side View
10" H
10" W
5" D

GO COOLER

And Heat Up Sales!

GoGear® sunshades feature a basic, advanced, premium performance rating system, making it easier to educate consumers and trade them up to higher quality solutions. Snug-Fit™ neckline design provides better protection, fitting over 95% of vehicles on the market (nearly 20% more than the competition). New designs and packaging in 2014 dramatically boost shelf presence and improve the consumer experience.



BASIC QUALITY LEVEL

2 LAYER

Our basic foam insulator with a reflective coating to deliver basic durability for the economical consumer

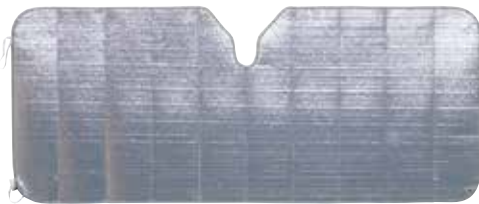

REFLECTIVE SILVER

STANDARD SIZE

6 pcs.
OPEN STOCK
SP120901S
Without Tray

6 pcs.
TRAY PACK
SP120201S
With Tray

JUMBO SIZE

6 pcs.
OPEN STOCK
SP120901J
Without Tray

6 pcs.
TRAY PACK
SP120201J
With Tray



ADVANCED QUALITY LEVEL

3 LAYER

Two reflective layers around an extra thick air insulator provide up to 10 times more rigidity than a basic two layer shade



REFLECTIVE SILVER

STANDARD SIZE

6 pcs.
OPEN STOCK
SP130901S
Without Tray

6 pcs.
TRAY PACK
SP130801S
With Tray

JUMBO SIZE

6 pcs.
OPEN STOCK
SP130901J
Without Tray

6 pcs.
TRAY PACK
SP130801J
With Tray

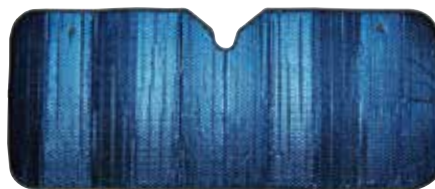

REFLECTIVE BLUE

STANDARD SIZE

6 pcs.
OPEN STOCK
SP130902S
Without Tray

6 pcs.
TRAY PACK
SP130802S
With Tray

JUMBO SIZE

6 pcs.
OPEN STOCK
SP130902J
Without Tray

6 pcs.
TRAY PACK
SP130802J
With Tray



3 LAYER

Features a double thick foam insulator and bonded backer to create up to 25 times more rigidity than a basic 2 layer shade. Each shade has a sewn or print pattern

**PREMIUM
QUALITY LEVEL**

Maximize the Appeal of Your Assortment

Our fresh, innovative and on-trend designs have the widest reach of appeal of any sunshade provider in the market ... which will help you increase your sales

Fashion that consistently out performs the competition



THE PATRIOT Show your True Colors

STANDARD SIZE		JUMBO SIZE	
6 pcs. OPEN STOCK	6 pcs. TRAY PACK	6 pcs. OPEN STOCK	6 pcs. TRAY PACK
SP120920S Without Tray	SP120620S With Tray	SP120920J Without Tray	SP120620J With Tray



SAIL AWAY Inspires the Journey

STANDARD SIZE		JUMBO SIZE	
6 pcs. OPEN STOCK	6 pcs. TRAY PACK	6 pcs. OPEN STOCK	6 pcs. TRAY PACK
SP120903S Without Tray	SP120403S With Tray	SP120903J Without Tray	SP120403J With Tray



NEW

TIGER EYE Natural Beauty

STANDARD SIZE	JUMBO SIZE
6 pcs. TRAY PACK	6 pcs. TRAY PACK
SP120916S With Tray	SP120916J With Tray



CARBON FIBER Contemporary Pattern

STANDARD SIZE		JUMBO SIZE	
6 pcs. OPEN STOCK	6 pcs. TRAY PACK	6 pcs. OPEN STOCK	6 pcs. TRAY PACK
SP120905S Without Tray	SP120605S With Tray	SP120905J Without Tray	SP120605J With Tray



NEW

PACIFIC VIBE Cool Pacific Blue

STANDARD SIZE	JUMBO SIZE
6 pcs. TRAY PACK	6 pcs. TRAY PACK
SP120912S With Tray	SP120912J With Tray



INTERIOR ACCESSORIES

STANDARD SIZE : 57" W x 23" H | JUMBO SIZE : 65" W x 27" H

GO GEAR

POP-UP SHADES

- Ultra compact design minimizes storage space
- Easily pops up to use and folds down to store



NEW

Pacific Vibe - Cool Pacific Blue

STANDARD SIZE

6 pcs.

OPEN STOCK

36 pcs.

FLOOR DISPLAY

SP240612S

SP240612SFD

JUMBO SIZE

6 pcs.

OPEN STOCK

36 pcs.

FLOOR DISPLAY

SP240612J

SP240612JFD



Flower Power - Energetic Playful Design

STANDARD SIZE

6 pcs.

OPEN STOCK

36 pcs.

FLOOR DISPLAY

SP240620S

SP240620SFD

JUMBO SIZE

6 pcs.

OPEN STOCK

36 pcs.

FLOOR DISPLAY

SP240620J

SP240620JFD



Sail Away - Inspires the Journey

STANDARD SIZE

6 pcs.

OPEN STOCK

36 pcs.

FLOOR DISPLAY

SP240603S

SP240603SFD

JUMBO SIZE

6 pcs.

OPEN STOCK

36 pcs.

FLOOR DISPLAY

SP240603J

SP240603JFD



Silver - Simple Neutral Style

STANDARD SIZE

6 pcs.

OPEN STOCK

36 pcs.

FLOOR DISPLAY

SP240401S

SP240401SFD

JUMBO SIZE

6 pcs.

OPEN STOCK

36 pcs.

FLOOR DISPLAY

SP240401J

SP240401JFD

SUPER JUMBO

38" W x 31" H

6 pcs.

OPEN STOCK

SP240401P



SP280804R

Rear Window Shade

6 pcs.

OPEN STOCK

TRAY PACK

CLIP STRIP

SIDE KICK

FLOOR DISPLAY

SP280804R



SP571204

PERSONAL TOWER FAN

The Personal Tower Fan is the only fan designed for today's vehicles. 12V of power directs cool air, even to rear seat passengers who may receive less air. Fits conveniently in any cupholder. Simply adjust the louvers to direct as much or little air flow as desired.



SP571204

- Personal use fan fits any cupholder
- Great for both front and rear seat passengers
- Provides additional comfort and airflow on hot summer days



SP570804 12V Oscillating Fan



SP570804

- Powers from any standard vehicle 12V outlet
- Oscillates 90 degrees to cool the entire vehicle
- Includes clamp and screws for easy attachment to console or dash



SP2603041 Corner QuickCling™



SP2603041

- Press and stick innovation - no suction cups
- Remove and replace easily - no marks or residue
- Filters heat and sun for backseat passengers



SP2605042 QuickCling™ Pop Up Side Shade



SP2605042 SP2605042CS SP2605042SK

- Press and stick innovation - no suction cups
- Remove and replace easily - no marks or residue
- Filters heat and sun for backseat passengers



SP3503041 Pull Down Side Shade



SP3503041

- Attaches to side window using suction cups or held in place by window
- Pulls down to filter sunlight, heat and glare
- Rolls up at the touch of a button



SP2805042 Pop Up Side Shade



SP2805042 SP2805042CS SP2805042SK

- Easy to remove and reuse
- Filters heat and glare for backseat passengers
- Attaches easily to side windows using suction cups (included)



SP4605041 Cling Shade



SP4605041

- Attaches to side window using static energy
- Filters heat and glare safely and easily
- Won't damage windows

MERCHANDISING MENU

- OPEN STOCK
- TRAY PACK
- CLIP STRIP
- SIDE KICK
- FLOOR DISPLAY



TRAY PACKS

Organize your planogram and boost holding power

Part #	Description	Pcs.
1220702013	Euro Mini Console (Charcoal)	3 pcs.
1220702053	Euro Mini Console (Black)	3 pcs.
1220715013	Seat Console (Charcoal)	2 pcs.
1220715053	Seat Console (Black)	2 pcs.
ASH-COIN	Ash Bin with bonus coin holder	6 pcs.
CARGO-BLA	Cargo Organizer	3 pcs.
CARGO-CAR-PDQ	Cargo Carrier	3 pcs.
CMPTORG-BLA-PDQ	Compact Organizer	3 pcs.
EFF-CHA/PDQ	Efficiency Console (Charcoal)	5 pcs.
FULLORG-BLA-PDQ	Full Size Organizer	3 pcs.
OTS2-BLA-PDQ	Over The Seat Organizer	3 pcs.
TRASH-BLA-PDQ	Pop-Up Trash Can	6 pcs.
TRASH13-BLA-PDQ	Tall Pop-Up Trash Can	6 pcs.
TRU-BLA-PDQ	Storagemaster Cargo Organizer	3 pcs.



CLIP STRIPS

Add a clip strip for increased off-shelf sales

Part #	Description	Pcs.
TRASH-BLA-CS	Pop Up Trash Can	6 pcs.
TRASH10-BLA-CS	Space Saver Trash Can	6 pcs.
TRASH13-BLA-CS	Tall Pop Up Trash Can	6 pcs.
VENT-05-CS	GoGear Vent Pack Organizer	6 pcs.
VENT-10-CS	GoGear Vent Pack XL Organizer	6 pcs.
SP2605042CS	QuickCling Side Shade	6 pcs.
SP2603041	Corner QuickCling	6 pcs.
GOBAND	GoBand Organizer	6 pcs.



SIDE KICKS

Add a sidekick during key promotional periods and increase sales by up to 40%

Part #	Description	Pcs.
VENT-05-SK	GoGear Vent Pack Organizer	18 pcs.
VENT-10-SK	GoGear Vent Pack XL Organizer	18 pcs.
SP2605042SK	QuickCling Side Shade	18 pcs.
SP2805042SK	Pop Up Side Shade with Suction Cups	18 pcs.





FLOOR DISPLAYS

GoGear® floor displays increase seasonal sale opportunities

Part #	Description	Pcs.
SP120901FD	Basic Silver Folding Shade (12 Standard & 12 Jumbo)	24 pcs.
SP120901JFD	Basic Silver Jumbo Folding Shade	24 pcs.
SP120901SFD	Basic Silver Standard Folding Shade	24 pcs.
SP130901FD	Advanced Silver Folding Shade (6 Standard & 6 Jumbo)	12 pcs.
SP130901JFD	Advanced Silver Jumbo Folding Shade	12 pcs.
SP130901SFD	Advanced Silver Standard Folding Shade	12 pcs.
SP130902JFD	Advanced Blue Jumbo Folding Shade	12 pcs.
SP130902SFD	Advanced Blue Standard Folding Shade	12 pcs.
SP120912FD	Premium "Pacific Vibe" 12 Standard & 12 Jumbo Folding Shade	24 pcs.
SP120916FD	Premium "Tiger Eye" 12 Standard & 12 Jumbo Folding Shade	24 pcs.
SP120920JFD	Premium Patriot Jumbo Folding Shade	24 pcs.
SP120920SFD	Premium Patriot Standard Folding Shade	24 pcs.
SP120920FD	Premium Patriot 12 Standard & 12 Jumbo Folding Shade	24 pcs.
SP240401JFD	Pop Up "Silver" Jumbo	36 pcs.
SP240401SFD	Pop Up "Silver" Standard	36 pcs.
SP240603JFD	Pop Up "Sail Away" Jumbo	36 pcs.
SP240603SFD	Pop Up "Sail Away" Standard	36 pcs.
SP240612JFD	Pop Up "Pacific Vibe" Jumbo	36 pcs.
SP240612SFD	Pop Up "Pacific Vibe" Standard	36 pcs.
SP240620JFD	Pop Up "Flower Power" Jumbo	36 pcs.
SP240620SFD	Pop Up "Flower Power" Standard	36 pcs.
SP120905FD	Advanced Silver (6 Jumbo), Premium Carbon Fiber (6 Jumbo), Premium Carbon Fiber (18 Standard)	30 pcs.



Floor display shown with gray, black & beige floor mats

79080 16-Set Heavy-Duty Floor Mat Metal Rack Display

Great for key fall and spring promotions, or utilize all year long to emphasize new innovation.

- Free with initial purchase of 16 sets of mats
- Mix and match floor mats (in full case quantities)
- Order floor mats separately

SNOW AND ICE TOOLS



WORLD'S #1 SELLING WINTER CARE BRANDS™ **FOR GOOD REASONS**

UNMATCHED EXPERTISE

Subzero® and Mallory® offer more than 100 years of experience in the winter category, consistently providing consumers with effective solutions to snow & ice removal.

GLOBAL SUPPLY CHAIN

With offices located across the USA, Canada, and Asia you can be assured that you are getting the best quality, most cost effective products on the market.

INNOVATIVE PRODUCT

Subzero and Mallory are committed to continuing the development of the most innovative, high performance wintercare products possible.





13929
Faux Fur Scraper Mitt

12 pcs.
 OPEN STOCK TRAY PACK CLIP STRIP SIDE KICK
 13929

- Elegant faux rabbit fur creates a high perceived consumer value
- Ultra soft polyester lining provides warmth and comfort
- A perfect gift item



Available in Assorted Colors
13920
Premium Ice Scraper Mitt

12 pcs. 12 pcs.
 OPEN STOCK TRAY PACK CLIP STRIP SIDE KICK
 13920 13920CS

- Quilted outer layer for exceptionally soft feel
- Cotton core and fleece lining for extra warmth and comfort
- Durable scraper breaks through the toughest ice



15511
11" Talon™ Ice Scraper

24 pcs.
 OPEN STOCK TRAY PACK CLIP STRIP SIDE KICK
 15511

- Premium soft-touch rubber grip for ultimate comfort
- Patented 2-way, push-pull scraper design for faster removal of ice and frost

RELENTLESS INNOVATION...



Ice Chippers

The addition of aggressive ice chippers to many blades assist in removing tough ice when using the corner. These more robust chippers help prevent blade breakage.



Curved Power Pole™

The Curved Power Pole™ solves the consumer problem of clearing ice while reaching across the windshield. This innovation gives consumers the proper angle of attack to remove ice at a distance.



S24-994
10" MAXX® XS Ice Scraper

24 pcs.
 OPEN STOCK TRAY PACK CLIP STRIP SIDE KICK FLOOR DISPLAY PALLET
 S24-994

- 10" Wide scraper allows for quick and easy ice and frost removal
- Strong ice chippers on top of the blade breaks up the thickest ice
- Contour foam grip provides ultimate comfort and control



13014
10" Ice Chisel® Scraper

12 pcs. 24 pcs. 48 pcs.
 OPEN STOCK TRAY PACK CLIP STRIP SIDE KICK
 13014 13044 13058

- Top performing product
- Patented 2-blades-in-1 design, ice chipping plus frost removal
- Foam grip available in assorted colors



1124F
11" Klondike® Ice Scraper

24 pcs.
 OPEN STOCK TRAY PACK CLIP STRIP SIDE KICK
 1124F

- Flat, compact design for easy storage
- Oversized chippers for superior ice breaking power
- Wide 4" frost clearing blade



16621
11" Ice Crusher™ Scraper

24 pcs.
 OPEN STOCK TRAY PACK CLIP STRIP SIDE KICK
 16621

- Two durable blades - one for frost, one for ice
- Extra wide 4 1/2" blade
- Foam comfort grip



14013
11" Avalanche™ Ice Scraper

24 pcs.
 OPEN STOCK TRAY PACK CLIP STRIP SIDE KICK
 14013

- Aggressive blade breaks through the thickest ice
- Added leverage positions allow application of more pressure to the blade
- Cushioned grip for comfortable scraping



16250
10" Ice Ripper™ Scraper

24 pcs.
 OPEN STOCK TRAY PACK CLIP STRIP SIDE KICK
 16250

- Built-in ice chippers break up tough ice
- Wide blade easily clears away frost
- Cushioned grip for comfortable scraping

...YIELDS SUPERIOR PRODUCTS



Quick-Lock™ Extender

Easily locks into the desired length, extending the usable range with the press of a thumb.



Pivoting Head

Pivoting snowbrooms provide multiple brush head positions allowing quick and effective cleaning, switching from broom to brush with the push of a button.



16211
10" Ice Ripper™ Ergonomic Scraper

24 pcs.
 OPEN STOCK TRAY PACK CLIP STRIP SIDE KICK
 16211

- Ergonomic, rounded handle for greater grip power and comfort
- Thumb "button" allows application of more pressure to the blade



16721
10" Bear Claw® Ice Scraper

24 pcs. 80 pcs.
 OPEN STOCK TRAY PACK CLIP STRIP SIDE KICK
 16721 16738

- Flat, compact design for easy storage
- Most popular OPP scraper
- Wide 4" frost clearing blade

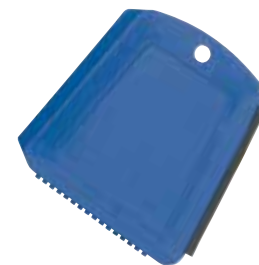

18424
FrostBiter™ Ice Scraper

24 pcs.
 OPEN STOCK TRAY PACK CLIP STRIP SIDE KICK
 18424

- Convenient size — fits in your door pocket or glove box
- 3-in-1 tool — includes scraper, chippers and squeegee
- Great for checkout counter

WORKS SMARTER AND HARDER

The Ultimate Snowbrush Innovation

Power Series Snowbrush™

The SubZero 26" Power Series Snowbrush leverages consumer insights, providing unmatched, effective snow and ice removal. This new mid-sized snowbrush features a new-to-the world reversible DUO Blade and two ergonomically designed grips that improve the user's ability to attack ice or heavy frost from the driver side or passenger side of the vehicle without damaging the bristles.

NEW

18520
Power Series 26" Snowbrush

12
pcs.

OPEN STOCK TRAY PACK CLIP STRIP

18520

- Dual grip zones improve leverage against thick ice
- Reversible blade improves ergonomics from both sides of the vehicle

Includes two "wiper notches" specifically designed to effectively remove icy buildup from wiper blades.



GIANT BRUSH HEAD

Mallory Assorted Colors



999-CT
35" Ultra Maxx®

6
pcs.

OPEN STOCK TRAY PACK CLIP STRIP

999-CT

- Five rows of bristles quickly remove deep snow
- Lightweight aluminum pole for ease of use for all consumers
- Contour foam grip provides ultimate comfort



Extends to
42"

Available in Assorted Colors

13054
42" Ice Chisel®
Telescopic Snowbrush

12
pcs.

12
pcs.

OPEN STOCK TRAY PACK CLIP STRIP SIDE KICK FLOOR DISPLAY PALLET

13054

13059

- Ice Chisel® scraper with 2 blades in 1, ice chipping plus frost removal
- Leverage point for added power and less fatigue
- Extra reach with telescoping steel handle



16620
35" Ice Crusher™ Snowbrush

12
pcs.

OPEN STOCK TRAY PACK CLIP STRIP SIDE KICK FLOOR DISPLAY PALLET

16620

- 35" length with dual comfort grips
- Dual action bristles provide soft protection and interior brushing power
- Separate frost and ice blades



14014
35" Avalanche™ Snowbrush

14 pcs.	TRAY PACK	CLIP STRIP	SIDE KICK	FLOOR DISPLAY	PALLET
OPEN STOCK	14014				

- Aggressive blade breaks through the thickest ice
- Added leverage positions allow application of more pressure to the blade
- Heavy-duty brush provides long reach for large vehicles

Mallory Assorted Colors



996-35
35" MAXX® X35

12 pcs.	TRAY PACK	CLIP STRIP	SIDE KICK	20 pcs.	FLOOR DISPLAY	PALLET
OPEN STOCK	996-35			F20-996-35		

- 35" length allows for long reach while scraping or brushing off snow and ice
- Full brush head easily removes snow from hard to clear areas
- Lightweight aluminum pole allows for easy use for all consumers



13781
35" Blizzard™ Snowbrush

14 pcs.	TRAY PACK	CLIP STRIP	SIDE KICK	18 pcs.	FLOOR DISPLAY	180 pcs.	PALLET
OPEN STOCK	13781			3518FD		35180	

- Heavy-duty brush provides long reach for large vehicles
- Contoured soft cushion grip
- Coated, heavy-duty handle



13024
32" Ice Chisel™ Snowbrush

12 pcs.	TRAY PACK	CLIP STRIP	SIDE KICK	FLOOR DISPLAY	PALLET
OPEN STOCK	13024	13025			

- Heavy-duty brush provides long reach for large vehicles
- Ice Chisel® scraper with 2-blades-in-1, ice chipping plus frost removal
- Strong handle with soft cushion grip

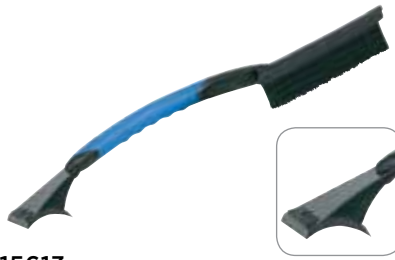

15613
23" Falcon™ Snowbrush

12 pcs.	TRAY PACK	CLIP STRIP	SIDE KICK	FLOOR DISPLAY	110 pcs.	PALLET
OPEN STOCK	15613				23110Q	

- Ergonomic styling with non-slip grips
- Double row bristles remove heavy snow
- Quickly remove ice with patented 2-way, push-pull scraper design



532
26" Cool Snow Tool®

12 pcs.	24 pcs.	TRAY PACK	CLIP STRIP	SIDE KICK	20 pcs.	FLOOR DISPLAY	PALLET
OPEN STOCK	532	S24-532			F20-532		

- Four rows of sturdy bristles provide a thick and full brush for snow removal
- Curved handle provides an ergonomic design
- Foam grip provides ultimate comfort

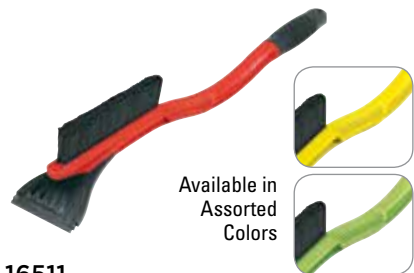

16511
23" Ice Hammer™ Snowbrush

8 pcs.	TRAY PACK	CLIP STRIP	SIDE KICK	FLOOR DISPLAY	160 pcs.	PALLET
OPEN STOCK	16511				16528	

- Unique design allows for longer reach
- Soft-molded grip repels water and withstands UV rays for longer life
- Built-in ice chippers break up tough ice



19621
22" Duo-Grip™ Snowbrush

10 pcs.	TRAY PACK	CLIP STRIP	SIDE KICK	FLOOR DISPLAY	176 pcs.	PALLET
OPEN STOCK	19621				19618	

- Control grip above blade for extra power
- Ice Ripper™ blade clears a wide path every time
- Foam grip for comfort



16024
21" Ice Ripper™ Snowbrush

20 pcs.	TRAY PACK	CLIP STRIP	SIDE KICK	FLOOR DISPLAY	PALLET
OPEN STOCK	16024				

- Durable design encourages step-up sales
- Aggressive scraper blade
- Palm pad for increased leverage

THE CURVE CHANGES EVERYTHING

Crossover Super-Duty Snowbroom™

- Curved pole makes scraping easier
- Pivoting brush sweeps and pushes snow
- Scraper cuts through thick frost and ice

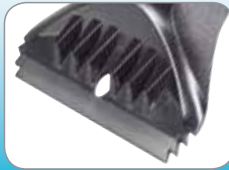

Built-in ice chippers break up tough ice and the wide blade easily clears away any frost

Subzero solved the toughest problem of ice removal ... clearing ice while reaching across the windshield. It took the breakthrough of the Curved Power Pole™ to give consumer the proper angle of attack. It's been called "A Game Changer".

Push the button and the pivoting brush becomes a broom



Mallory Assorted Colors

523 24" Slimline 24

24 pcs.	24 pcs.	24 pcs.			
OPEN STOCK	TRAY PACK	CLIP STRIP	SIDE KICK	FLOOR DISPLAY	PALLET
523	S24-523			F24-523	

- Molded contour grip for comfort
- Durable bristles to sweep snow off your vehicle
- Strong ice scraper provides quick and easy ice/frost removal



19520 22" Super Deluxe™ Snowbrush

	20 pcs.	48 pcs.	168 pcs.
OPEN STOCK	TRAY PACK	CLIP STRIP	SIDE KICK
	19520	2248FD	19518

- World's best selling snowbrush, often copied, but never duplicated
- Includes a wide 4" Bear Claw® Blade
- Perfect for small to medium size passenger vehicles

BRUSH FOR THE PRICE OF A SCRAPER



Mallory Assorted Colors

S18-518 16" SnoWEeV™

	18 pcs.
OPEN STOCK	TRAY PACK
	S18-518

- 16" Compact design stores easily
- Contour design allows for a better grip



203 25" Valu Reach Sweep™ Wood Handle

24 pcs.					
OPEN STOCK	TRAY PACK	CLIP STRIP	SIDE KICK	FLOOR DISPLAY	PALLET
203					

- Constructed with high quality material for long lasting durability
- Strong ice scraper with ice chippers removes ice quickly and easily
- Popular among traditional consumers

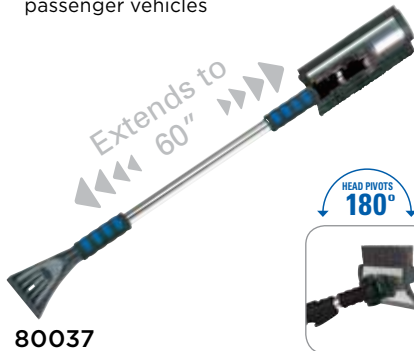

80037 60" Quick Lock™ Pivoting Snowbroom

6 pcs.					
OPEN STOCK	TRAY PACK	CLIP STRIP	SIDE KICK	FLOOR DISPLAY	PALLET
80037					

- Quick Lock extension pole reaches 60"
- Extra wide scraper blade
- Pivoting soft bristle snowbroom and squeegee
- Great for trucks, SUV's & RV's

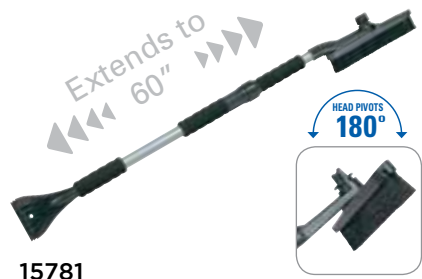

15781 60" Monster™ Swivel Snowbroom

8 pcs.					
OPEN STOCK	TRAY PACK	CLIP STRIP	SIDE KICK	FLOOR DISPLAY	PALLET
15781					

- 60" reach when fully extended
- Super heavy-duty steel tube for extended reach
- Extra wide blade for maximum ice removal

THE CROSSOVER SERIES™



14026
26" Crossover

6 pcs.
 OPEN STOCK TRAY PACK CLIP STRIP SIDE KICK FLOOR DISPLAY PALLET
 14026



Extends to 35"
14035
35" Crossover

6 pcs.
 OPEN STOCK TRAY PACK CLIP STRIP SIDE KICK FLOOR DISPLAY PALLET
 14035



14038
38" Crossover

6 pcs.
 OPEN STOCK TRAY PACK CLIP STRIP SIDE KICK FLOOR DISPLAY PALLET
 14038



Extends to 50"
14039
50" Crossover

6 pcs.
 OPEN STOCK TRAY PACK CLIP STRIP SIDE KICK FLOOR DISPLAY PALLET
 14039

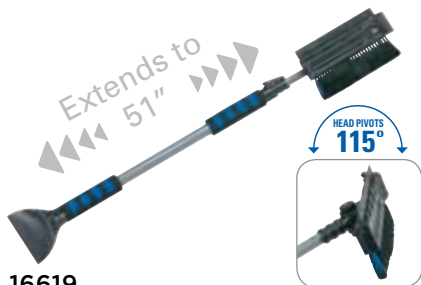

16619
51" Ice Crusher™ Pivoting Snowbroom

6 pcs.
 OPEN STOCK TRAY PACK CLIP STRIP SIDE KICK FLOOR DISPLAY PALLET
 16619

- Most durable product on the market
- Pivoting snowbroom with dual action bristles, squeegee and ice chippers
- Separate frost and ice blades

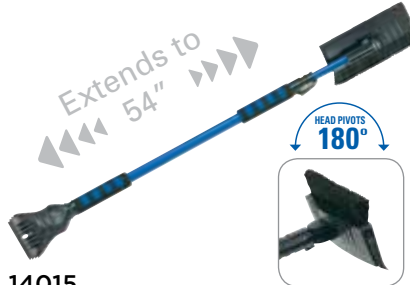

14015
54" Avalanche™ Pivoting Snowbroom

12 pcs.
 OPEN STOCK TRAY PACK CLIP STRIP SIDE KICK FLOOR DISPLAY PALLET
 14015

- Aggressive blade breaks through thick ice
- Added leverage positions for directing more pressure to the blade
- Heavy-duty pivoting broom provides long reach for large vehicles and squeegee

MOVE SNOW LIKE A PRO

Extends to 54"

Available in Assorted Colors

14403
54" Snow Plow

12 pcs.
 OPEN STOCK TRAY PACK CLIP STRIP
 14403

- Foam plow clears heavy snow
- Folds flat for easy storage
- All-in-1 winter snow tool



Available in Assorted Colors

5412PBT
54" Pivoting Snowbroom with 8½" Head

12 pcs.
 OPEN STOCK TRAY PACK CLIP STRIP SIDE KICK FLOOR DISPLAY PALLET
 5412PBT

- New & improved brush head design
- Wide 8½" sweeping area with tall head
- Squeegee clears light frost & water



583-EP
52" Pivot Head Sport Telebroom™

6 pcs. 14 pcs.
 OPEN STOCK TRAY PACK CLIP STRIP SIDE KICK FLOOR DISPLAY PALLET
 583-EP F14-583-EP

- Extends from 34" to 52" for maximum reach
- Pivoting broom head also features a rubber squeegee
- Contour foam grip provides ultimate comfort



Available in Assorted Colors

3512PBT
35" Pivoting Snowbroom with 8½" Head

12 pcs.
 OPEN STOCK TRAY PACK CLIP STRIP SIDE KICK FLOOR DISPLAY PALLET
 3512PBT

- New & improved brush head design
- Wide 8½" sweeping area with tall head
- Squeegee clears light frost & water



580-EP
35\"/>

6 pcs.	15 pcs.
OPEN STOCK	FLOOR DISPLAY
TRAY PACK	PALLET
CLIP STRIP	
SIDE KICK	

- Extends from 26" to 35" to provide a longer reach
- Pivoting broom head also features a rubber squeegee
- Compact design for easy storage



581-E
48\"/>

6 pcs.	12 pcs.
OPEN STOCK	FLOOR DISPLAY
TRAY PACK	PALLET
CLIP STRIP	
SIDE KICK	

- Extends from 30" to 48" for added length and reach
- Twist-lock allows for quick and easy length adjustments
- Easily pushes snow off of roof, hood and front windshield



2610XM
52\"/>

10 pcs.	72 pcs.
OPEN STOCK	FLOOR DISPLAY
TRAY PACK	PALLET
CLIP STRIP	
SIDE KICK	

- Heavy-duty broom for snow clearing power
- Steel extender handle with soft cushion grip
- Extra wide blade with convenient squeegee



2610XB
48\"/>

10 pcs.	20 pcs.	120 pcs.
OPEN STOCK	FLOOR DISPLAY	PALLET
TRAY PACK		
CLIP STRIP		
SIDE KICK		

- Provides up to 100% longer reach when extended
- Wide blade and broom extend to 48"
- Great for larger vehicles



511-E
36\"/>

10 pcs.	16 pcs.
OPEN STOCK	FLOOR DISPLAY
TRAY PACK	PALLET
CLIP STRIP	
SIDE KICK	

- Extends from 23" to 36" to provide a longer reach
- Twist-lock allows for quick and easy length adjustments
- Perfect for small-to-mid-size vehicles



3610XM
36\"/>

10 pcs.	
OPEN STOCK	
TRAY PACK	
CLIP STRIP	
SIDE KICK	

- Heavy-duty broom for snow clearing power
- Steel extender handle with soft cushion grip
- Extra wide blade with convenient squeegee



1210XM
26\"/>

10 pcs.	
OPEN STOCK	
TRAY PACK	
CLIP STRIP	
SIDE KICK	

- Provides up to 100% longer reach when extended
- Wide blade and broom extend to 48"
- Great for larger vehicles

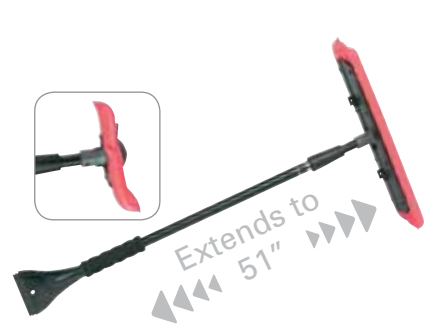

18833
51\"/>

8 pcs.	10 pcs.
OPEN STOCK	FLOOR DISPLAY
TRAY PACK	PALLET
CLIP STRIP	
SIDE KICK	

- Super wide 16+ inch "Push-Pull" foam head clears snow quickly & won't scratch paint
- Telescoping steel handle for extra reach
- Scraper blade on opposite end for quick ice removal



18841
46\"/>

8 pcs.	8 pcs.	10 pcs.
OPEN STOCK	TRAY PACK	FLOOR DISPLAY
		PALLET
CLIP STRIP		
SIDE KICK		

- Super wide 16+ inch "Push-Pull" foam head clears snow quickly & won't scratch paint
- Telescoping steel handle for extra reach



18849
35" Mini Arctic Plow™

8 pcs.

OPEN STOCK TRAY PACK CLIP STRIP SIDE KICK FLOOR DISPLAY PALLET

18849

- Clears deep and heavy snow
- No-scratch material
- Long reach - yet small enough to store in any vehicle

SEE A BETTER ROAD AHEAD



Boost early season sales while also supporting breast cancer awareness. SubZero and Mallory have teamed up to support the National Breast Cancer

Foundation, Inc. ® (NBCF) by offering seven different pink items to help support the NBCF. A portion of all sales will be donated to NBCF in support of their mission; to save lives through increasing breast cancer awareness through education, provide diagnostic breast cancer care services for those in need, and provide nurturing support services.

A DONATION IS MADE FOR EVERY PINK PRODUCT SOLD



NBCF13920
Mitt Scraper

30 pcs.

TRAY PACK

NBCF13920

- Quilted outer layer in vibrant pink
- Cotton core and pink fleece lining for extra warmth and comfort



NBCF14026
26" Crossover Snowbroom

6 pcs.

TRAY PACK

NBCF14026

- 26" curved pink pole makes scraping easier
- Pivoting brush sweeps and pushes snow



577-EPKUS
45" Telescopic Snowbroom

12 pcs.

TRAY PACK

Multiple Quantities.

FLOOR DISPLAY

S12-577-EPKUS See Page 69

- Extends from 28" to 45" for increased reach
- Contour foam grip provides ultimate comfort



886PKUS
31" Pink Snowbrush

30 pcs.

TRAY PACK

Multiple Quantities.

FLOOR DISPLAY

S30-886PKUS See Page 69

- Strong ice scraper to remove frost and heavy ice
- Thick, full brush for easy snow removal
- Lightweight aluminum pole provides ease of use for all consumers



S24-527PKUS
22" Pink Snowbrush

24 pcs.

TRAY PACK

24 pcs.

FLOOR DISPLAY

S24-527PKUS DS58-3BHPKUS

- Effective scraper cuts through frost and heavy ice
- Brush easily clears snow from all areas of the vehicle
- Compact size for effective storage



NBCF16024
21" Ice Ripper™ Snowbrush

20 pcs.

TRAY PACK

NBCF16024

- Durable design with pink handle
- Aggressive scraper blade



994PKUS
10" Pink Ice Scraper

24 pcs.

TRAY PACK

Multiple Quantities.

FLOOR DISPLAY

994PKUS See Page 69

- Easily removes frost and heavy ice
- Easy to store in any vehicle
- Contour foam grip provides ultimate comfort

ULTIMATE SNOW AND ICE PROTECTION

The Heavy-Duty Arctic Guard is the largest windshield cover on the market. It keeps snow and ice off the windshield and side mirrors, eliminating difficult scraping. Adjustable straps provide a perfect fit for all vehicles. Folds into mirror pocket for easy storage.



17529 Heavy-Duty ArcticGuard™ Snow and Ice Windshield Cover 40" H 73" W

6 pcs.
 OPEN STOCK TRAY PACK CLIP STRIP

- Largest windshield cover on market ... fits all vehicles
- Easy to put on and take off
- Easy to use, easier to store



17511 ArcticGuard™ Snow and Ice Windshield Cover 29" H 70" W

6 pcs.
 OPEN STOCK TRAY PACK CLIP STRIP SIDE KICK FLOOR DISPLAY PALLET

- Eliminates difficult windshield scraping
- Folds compact for easy storage
- Packaging footprint is significantly smaller than competitive covers!



12201 Ice Cleats™

6 pcs. 12 pcs.
 OPEN STOCK TRAY PACK CLIP STRIP SIDE KICK FLOOR DISPLAY PALLET

- Aggressive spikes help prevent dangerous slips and falls
- One size fits most shoes
- Durable material for long lasting effectiveness



12501 GripTrax™ Traction Tools

4 pcs.
 OPEN STOCK TRAY PACK CLIP STRIP SIDE KICK FLOOR DISPLAY PALLET

- Place in front or behind tires for traction
- Designed to hold in place, won't fly out
- Works in snow, mud and sand



15295 57 Piece Winter Emergency Kit

4 pcs.
 OPEN STOCK TRAY PACK CLIP STRIP SIDE KICK FLOOR DISPLAY PALLET

- Must have items for winter emergencies
- Great accessory to increase sales
- Features: heavy-duty tow rope, multi-use whistle, LED flashlight and more

GIVE WINTER MESS THE BOOT

NEW

12550 Boot Tray

15" H 30" W 1.15" D

6 pcs.
 OPEN STOCK TRAY PACK CLIP STRIP

- Raised ridges allow footwear to thoroughly drip dry
- Easy to clean up
- Perfect accessory for any vehicle or home



Multiple Parts HotSpot™ Warmers

24 pcs.
 OPEN STOCK TRAY PACK CLIP STRIP SIDE KICK FLOOR DISPLAY PALLET
 See Below

- Up to 10 hours of heat for Hand Warmers and 8 hours for Toe Warmers, activates in seconds
- Reaches temps up to 140 degrees
- 2 warmers per pack

12324 - HotSpot™ Hand Warmers
12360 - HotSpot™ Toe Warmers

EXPECT THE UNEXPECTED

NEW DESIGN

The all-new SubZero Heavy Duty Aluminum Shovel was designed with a compact design for easy storage in any vehicle. This two-in-one shovel also allows you to move the handle into the shovel blade to provide a "scooping" feature great for digging your vehicle out of a snow bank or other tricky situation.



Available in Assorted Colors



17221 Heavy-Duty Aluminum Emergency Shovel

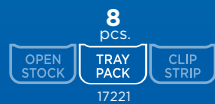

- Heavy-duty aluminum construction holds up to demanding jobs
- Extends to 33" for long reach
- A must have auto safety item in winter



Available in Gray



17211 Auto Emergency Shovel

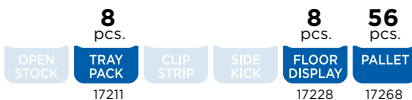

- Extends to 37" for long reach
- 9½" wide shovel head
- Compact for easy storage when closed

MAXIMIZING WINTER WEATHER PROFITS

SNOWSCOPE™



Our proprietary winter weather forecasting system is one of the most effective in-season tools available. It is designed to make sure you have the right inventory in the right place at the right time. Having the right product is just the first step. Only SnowScope™ maximizes your sales opportunity and increases consumer satisfaction. Contact your Hopkins Sales Manager to join this exclusive group.



Maximize your product holding power during heavy snow storms

Part #	Description	# Pcs.
3512PBT	35" Pivoting Snowbroom	12 pcs.
1124F	11" Klondike Ice Scraper	24 pcs.
12201	23" Ice Hammer Snowbrush	8 pcs.
12324	HotSpot Hand Warmers	24 pcs.
12360	HotSpot Toe Warmers	24 pcs.
13014	10" Ice Chisel Scraper	24 pcs.
13025	32" Ice Chisel Snowbrush	12 pcs.
13059	42" Ice Chisel Telescopic Snowbrush	12 pcs.
13781	35" Blizzard Snowbrush	14 pcs.
13920	Premium Ice Scraper Mitt	12 pcs.
14013	11" Avalanche Ice Scraper	24 pcs.
14014	35" Avalanche Snowbrush	14 pcs.
14015	54" Avalanche Pivoting Snowbroom	12 pcs.
14026	26" Crossover	6 pcs.
14035	35" Extendable Crossover	6 pcs.
14038	38" Crossover	6 pcs.
14039	50" Extendable Crossover	6 pcs.
14403	54" Snow Plow	12 pcs.
15275	83 Piece Large Winter Emergency Kit	4 pcs.
15285	36 Piece Small Winter Emergency Kit	4 pcs.
15295	57 Piece Medium Winter Emergency Kit	4 pcs.
15511	11" Talon Ice Scraper	24 pcs.
15613	23" Falcon Snowbrush	12 pcs.
16024	21" Ice Ripper Snowbrush	20 pcs.
16211	10" Ice Ripper Ergonomic Scraper	24 pcs.
16250	10" Ice Ripper Scraper	24 pcs.
16511	23" Ice Hammer Snowbrush	8 pcs.
16619	51" Ice Crusher Pivoting Snowbroom	6 pcs.
16621	11" Ice Crusher Scraper	24 pcs.
16620	35" Ice Crusher Snowbrush	12 pcs.
16721	10" Bear Claw Ice Scraper	24 pcs.
17211	Auto Emergency Shovel	8 pcs.
17511	ArcticGuard Snow and Ice Windshield Cover	6 pcs.
18424	FrostBiter Ice Scraper	24 pcs.
18845	46" Arctic Plow with Grip	8 pcs.
19520	22" Super Deluxe Snowbrush	20 pcs.
5412PBT	54" Pivoting Snowbroom with 8½" Head	12 pcs.
994PKUS	10" Pink Ice Scraper	24 pcs.
S24-527PKUS	22" Pink Snowbrush	24 pcs.
NBCF16024	21" Pink Ice Ripper Snowbrush	6 pcs.
NBCF13920	Pink Mitt Scraper	30 pcs.
NBCF14026	26" Pink Crossover Snowbroom	6 pcs.
S24-532	26" Cool Snow Tool	24 pcs.
S24-523	24" Slimline 24	24 pcs.
S18-518	16" SnowWEeVil	18 pcs.
S12-577-EPKUS	45" Telescopic Snowbroom	12 pcs.
S30-886PKUS	31" Pink Snowbrush	30 pcs.



Drive impulse sales by positioning product in multiple locations throughout the store

Part #	Description	# Pcs.
13920CS	Premium Ice Scraper Mitt	12 pcs.

Create an end-of-aisle profitable shopping experience by featuring these snow & ice tool products

Part #	Description	# Pcs.
12212	Ice Cleats	12 pcs.
13058	10" Ice Chisel Scraper	48 pcs.
16738	10" Bear Claw® Ice Scraper	80 pcs.



Whether it's inside the front entrance or another key traffic location, floor displays create high impact display options

Part #	Description	# Pcs.
2248FD	22" Super Deluxe Snowbrush Floor Display	48 pcs.
2610FD	48" Extender Snowbroom Tee Pee Display	20 pcs.
3248	21" Ice Ripper Snowbrush Floor Display	32 pcs.
	10" Ice Ripper Scraper Floor Display	48 pcs.
3518FD	35" Blizzard Snowbrush Floor Display	18 pcs.
3648	22" Super Deluxe Snowbrush Floor Display	36 pcs.
	10" Bear Claw Floor Display	48 pcs.
5420FD	54" Pivoting Snowbroom with 8 1/2" Head Tee Pee Display	20 pcs.
17228	Auto Emergency Shovel Floor Display	8 pcs.
17297	Auto Emergency Shovel with Bonus Ice Ripper Scraper Floor Display	8 pcs.
18837	Arctic Plow with Scraper Floor Display	10 pcs.
18847	Arctic Plow with Grip Floor Display	10 pcs.
F20-996-35	35" MAXX X35	20 pcs.
F20-532	26" Cool Snow Tool	20 pcs.
F24-523	24" Slimline 24	24 pcs.
F14-583-EP	52" Pivot Head Sport Telebroom	14 pcs.
F15-580-EP	35" Mini Pivot Telebroom	15 pcs.
F12-581-E	48" Sport 8 Utility Broom	12 pcs.
F16-511-E	36" Telebroom	16 pcs.
D8-577-EPKS	45" Pink Telescopic Snowbroom	8 pcs.
D24-886PKUS	31" Pink Snowbrush	24 pcs.
DS58-2BPKUS	48 pcs. 886PKUS, 10 pcs. 577-EPKUS	58 pcs.
DS72-2SPKUS	48 pcs. 886PKUS, 24 pcs. 994PKUS	58 pcs.
DS58-3BHPKUS	24 pcs. 886PKUS, 24 pcs. 527PKUS, 10 pcs. 577-EPKUS	58 pcs.



DWRBRUSH2
2-Tier Spinner Rack

40 - 21" Ice Ripper Snowbrush
36 - 42" Ice Chisel Extendable Snowbrush
10 - 48" Extender Snowbroom
12 - 54" Pivoting Broom with 8 1/2" Head



DWR136
2-Tier Spinner Rack

48 - 10" Bear Claw Ice Scraper
24 - 10" Ice Chisel Scraper
40 - 22" Super Deluxe Snowbrush
24 - 32" Ice Chisel Snowbrush



DWR120
3-Tier Spinner Rack

48 - 10" Ice Ripper Ergonomic Scraper
40 - 22" Super Deluxe Snowbrush
32 - 23" Ice Hammer Snowbrush



EDWR-6
Empty 2-Tier/3-Tier Rolling Spinner Rack

Rolling Spinner Rack / Can be used with either 2 or 3 tiers (Included)



DWR20
Counter Display Spinner Rack

20 - 21" Ice Ripper Snowbrush



DWR48
Counter Display 2-Tier Spinner Rack

48 - 10" Ice Chisel Scraper

Late November and December result in as much as 50% of your seasonal sales. Capture this heavy traffic and create holding power by capitalizing on these high volume promotional vehicles.

Part #	Description	# Pcs.
13055	42" Ice Chisel Telescopic Snowbrush - 1/2 pallet	120 pcs.
16528	23" Ice Hammer Snowbrush - 1/2 pallet	160 pcs.
17268	Auto Emergency Shovel - 1/2 pallet	56 pcs.
19518	22" Super Deluxe Snowbrush - 1/4 pallet	168 pcs.
19618	22" Duo-Grip Snowbrush - 1/2 pallet	176 pcs.
23110Q	23" Falcon Snowbrush - 1/4 pallet	110 pcs.
26120	48" Extender Snowbroom - 1/2 pallet	120 pcs.
2672XM	52" Super Extender Snowbroom - 1/2 pallet	72 pcs.
35180	35" Blizzard Snowbrush - 1/2 pallet	180 pcs.
QP72-1PKUS	886PKUS	72 pcs.
QP58-2BPKUS	48 pcs. 886PKUS, 10 pcs. 577-EPKUS	58 pcs.
QP72-2SPKUS	48 pcs. 886PKUS, 24 pcs. 994PKUS	72 pcs.
QP58-3PKUS	24 pcs. 886PKUS, 24 pcs. 994PKUS, 10 pcs. 577-EPKUS	58 pcs.



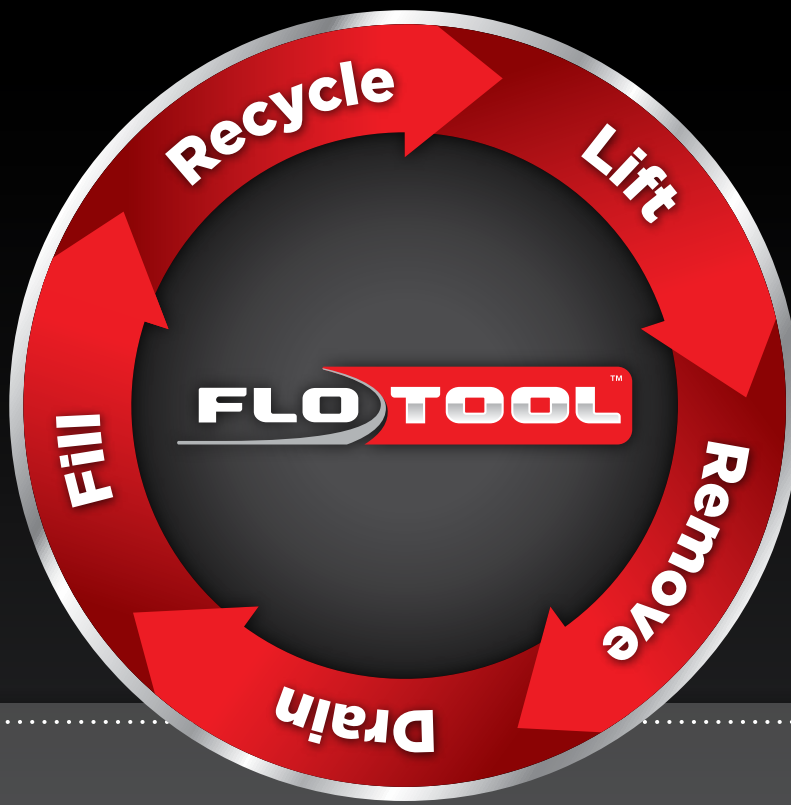

#1 IN FLUID MANAGEMENT

UNMATCHED RANGE OF PRODUCTS

Only FloTool® provides all of the tools to make the DIY oil change process easy ... from heavy duty ramps, to filter and drain plug wrenches, to oil drains, to funnels. And only FloTool can tailor your planogram with innovative step-up solutions that make vehicle maintenance easier for DIY'ers ... keeping your consumers satisfied and coming back for more!

INTEGRATED SHIPPING

All Miami, Oklahoma manufactured products are available from our Emporia, Kansas distribution center, giving you the opportunity to combine these items with all of our product lines shipped from Emporia.

For high volume customers, direct shipping of products manufactured in our Oklahoma location will provide the lowest cost for vehicle ramps and drain containers.

ALWAYS THE RIGHT BRAND

There is an intense battle for brand loyalty for oil, oil filters and antifreeze. FloTool is always compatible, regardless of your consumer's brand allegiance. Never lose a sale by having the wrong brand ... FloTool is always the right choice.







A new and improved structural design combined with super strong material makes the RhinoRamps® as strong as any other ramps on the market, resin or metal.



Nestability

The unique, nestable design not only saves space in the consumer's garage, but more pieces on a pallet means saving space in the warehouse, on the truck and on the retail shelf.

Better by Design

Our integrated Core-Trac™ non-skid feet reduce sliding during use while an improved tread pattern and wide design make these the most secure ramps on the market. The ramp design also works for low profile vehicles ... a feature many other ramps don't have!



11909MI
12,000 lb. GVW RhinoRamps®

1 pair

OPEN STOCK	CUT CASE	OFF SHELF	SIDE KICK	PALLET TOPPER	FLOOR DISPLAY
------------	----------	-----------	-----------	---------------	---------------

11909MI

- Nestable for maximum cube utilization
- 17 degree angle for low clearance vehicles
- Wide tire width



11912MI
16,000 lb. GVW RhinoRamps Max®

1 pair

OPEN STOCK	CUT CASE	OFF SHELF	SIDE KICK	PALLET TOPPER	FLOOR DISPLAY
------------	----------	-----------	-----------	---------------	---------------

11912MI

- Nestable for maximum cube utilization
- 17 degree angle for low clearance vehicles
- Extra-wide tire width



11930MI
Heavy Duty Wheel Chocks™

4 pair

OPEN STOCK	CUT CASE	OFF SHELF	SIDE KICK	PALLET TOPPER	FLOOR DISPLAY
------------	----------	-----------	-----------	---------------	---------------

11930MI

- Safety device to use with ramps or other lifting devices
- Prevents tires from rolling
- Not for commercial use



11933MI
Heavy Duty Chock and Block™

6 pcs.

OPEN STOCK	CUT CASE	OFF SHELF	SIDE KICK	PALLET TOPPER	FLOOR DISPLAY
------------	----------	-----------	-----------	---------------	---------------

11933MI

- Can be used as a trailer stand and chocks
- Superior for optimizing weight-bearing capacity
- Perfect for any boat trailer, RV, stock trailer, camper, etc.



11935MI
EasyLift Rider Ramps™

OPEN STOCK	4 pair	CUT CASE	OFF SHELF	SIDE KICK	PALLET TOPPER	16 pair	FLOOR DISPLAY
------------	--------	----------	-----------	-----------	---------------	---------	---------------

11935MI 11936MI

- Makes mower maintenance easy
- Provides 6" of lift
- Gripping points for use on concrete or grass



LIFT YOUR SALES AND YOUR CUSTOMERS' SATISFACTION

EasyLift Rider Ramps™ make mower maintenance easy. Their curved design allows the consumer to roll up onto the ramps rather than lifting the mower up onto blocks. Equipped with skid resistant rubber feet and molded in teeth for use on concrete or in the yard. A structurally sound, stackable design allow these ramps to hold up to 500 pounds and also take up less space on the retail shelf. Increase sales by placing a floor display next to your riding mowers.

TAKE THE SLIP OUT OF OIL CHANGES

The GRIPTECH™ family of wrenches uses a non-slip grip that is superior to traditional oil change tools.

This innovative grip allows the wrench to firmly grab the oil filter and remove it easily, quickly and without scrapes and bruises. Making the oil change easier can increase demand for DIY oil changes. That's exactly what GRIPTECH delivers.



10617GT Adjustable 3-Prong Wrench

6 pcs.

OPEN STOCK CUT CASE OFF SHELF SIDE KICK PALLET TOPPER FLOOR DISPLAY
10617GT

- Self adjusts to filter
- Fits oil filters 2 3/8" to 3 3/4" (60mm to 95mm) in diameter



10621GT Swivel Handle Small Band Wrench

6 pcs.

OPEN STOCK TRAY PACK OFF SHELF SIDE KICK PALLET TOPPER FLOOR DISPLAY
10621GT

- Remove oil filters in hard to reach areas
- Fits oil filters 2 7/8" to 3 5/16" (73mm to 85mm) in diameter



10622GT Swivel Handle Medium Band Wrench

6 pcs.

OPEN STOCK TRAY PACK OFF SHELF SIDE KICK PALLET TOPPER FLOOR DISPLAY
10622GT

- Remove oil filters in hard to reach areas
- Fits oil filters 3 3/8" to 3 3/4" (85mm to 95mm) in diameter



10634GT Swivel Handle Large Band Wrench

6 pcs.

OPEN STOCK TRAY PACK OFF SHELF SIDE KICK PALLET TOPPER FLOOR DISPLAY
10634GT

- Remove oil filters in hard to reach areas
- Fits oil filters 3 3/4" to 4 5/16" (95mm to 110mm) in diameter



10632GT Industrial Strength Rubber Strap Wrench

6 pcs.

OPEN STOCK TRAY PACK OFF SHELF SIDE KICK PALLET TOPPER FLOOR DISPLAY
10632GT

- Multiple automotive and household uses
- Fits objects up to 12" (304mm) in diameter



10633GT Adjustable Chain Wrench

6 pcs.

OPEN STOCK TRAY PACK OFF SHELF SIDE KICK PALLET TOPPER FLOOR DISPLAY
10633GT

- Adjustable chain fits a wide range of oil filter sizes
- Fits oil filters 2 1/2" to 4 7/16" (64mm to 112mm) in diameter



10620GT Swivel Handle Adjustable Band Wrench

6 pcs.

OPEN STOCK TRAY PACK OFF SHELF SIDE KICK PALLET TOPPER FLOOR DISPLAY
10620GT

- Accommodates four filter sizes in one
- Fits oil filters 2 3/4" to 4 1/4" (70mm to 108mm) in diameter



10627GT
Heavy-Duty
3-Position Pliers

6 pcs.
 OPEN STOCK CUT CASE OFF SHELF SIDE KICK PALLET TOPPER FLOOR DISPLAY
 10627GT

- Extra-long handles for hard to reach areas
- Fits oil filters 2 1/2" to 4 1/4" (63mm to 108mm) in diameter



10631GT
Jaw Style Wrench

6 pcs.
 OPEN STOCK CUT CASE OFF SHELF SIDE KICK PALLET TOPPER FLOOR DISPLAY
 10631GT

- Great for hard to reach filters
- Fits oil filters 2 3/4" to 4" (70mm to 102mm) in diameter



10630
Universal Drain Plug Wrench

6 pcs.
 OPEN STOCK CUT CASE OFF SHELF SIDE KICK PALLET TOPPER FLOOR DISPLAY
 10630

- High impact carbon steel
- Comfort grip
- 8 sizes fit virtually all vehicles (13, 14, 15, 16, 17, 18, 19, 24mm)



10614
Small Band Wrench

6 pcs.
 OPEN STOCK CUT CASE OFF SHELF SIDE KICK PALLET TOPPER FLOOR DISPLAY
 10614, 10614B/6

- 10614 Small Wrench (carded) 6 pcs. case
- 10614B/6 Small Wrench (bulk) 6 pcs. per case
- Inside grippers hold filter
- Fits oil filters 2 7/8" to 3 5/16" (73mm to 85mm) in diameter



10619
Nylon Strap Wrench

6 pcs.
 OPEN STOCK CUT CASE OFF SHELF SIDE KICK PALLET TOPPER FLOOR DISPLAY
 10619

- Uses 1/2" drive ratchet
- Removes filters up to 6" (152mm) in diameter



10615
Medium Band Wrench

6 pcs.
 OPEN STOCK CUT CASE OFF SHELF SIDE KICK PALLET TOPPER FLOOR DISPLAY
 10615, 10615B/6

- 10615 Medium Wrench (carded) 6 pcs. per case
- 10615B/6 Medium Wrench (bulk) 6 pcs. per case
- Inside grippers hold filter
- Fits oil filters 3 3/8" to 3 3/4" (85mm to 95mm) in diameter



Multiple Parts
Custom Fit Cap Wrench

6 or 12 pcs.
 OPEN STOCK CUT CASE OFF SHELF SIDE KICK PALLET TOPPER FLOOR DISPLAY
 Multiple Parts

10601-10609* Cap Wrench (carded) 6 pcs. per case
 10601B/12-10609B/12* Cap Wrench (bulk) 12 pcs. per case

- Super strong graphite
- No slip grip
- Will not conduct heat

*Filter specific



OIL CHANGE TOOLS

Want to have the assurance that you are offering your customers the right tools for the job? Check out Hopkins' complete line of high quality oil change tools that can be appreciated by any DIYer.

Provide them with an innovative 8-in-1 Universal Drain Plug Wrench that fits virtually all vehicles. Allow your consumers to get to and remove even the trickiest of oil filters by providing them with a mixture of any of our 9 GRIPTECH and 12 standard high quality oil filter wrenches.



DRAIN FLUIDS WITH EASE

Simple Drain

Low cost drain pans are the most versatile drain because they will work for all types of vehicles. They are great for catching the fluid, but then must be transferred to a container to be taken to the recycling center.

Drain And Contain

Step consumers up from a basic drain pan to a higher quality, higher retail drain container. Containers not only capture the fluid, but double as a transportation device to the recycling center.

Super-Duty Series

The giant 58 Quart and 24 Quart Drain are specifically designed for larger vehicles and farm equipment that go beyond typical drain containers. Built FloTool tough and guaranteed not to leak! Ideal for a serious DIY or farm/ag customer.



SUPER DUTY SERIES



42008MI
58 Quart
Drain Container™

1
pc.

OPEN STOCK CUT CASE OFF SHELF SIDE KICK PALLET TOPPER FLOOR DISPLAY
42008MI

- Large capacity for multiple oil changes or commercial use
- Can be stored upright or flat
- Built-in wheels aid in maneuverability



42004MI
24 Quart
Drain Container™

2
pcs.

OPEN STOCK CUT CASE OFF SHELF SIDE KICK PALLET TOPPER FLOOR DISPLAY
42004MI

- Deep recess reduces splatter
- Three ergonomic handgrips for easy transport
- Can be stored upright or flat



11838MI
15 Quart
Drain Container™

Updated cap reduces breakage & improves performance

4 pcs.
11838MI

OPEN STOCK CUT CASE OFF SHELF SIDE KICK PALLET TOPPER FLOOR DISPLAY

- Large capacity holds multiple oil changes
- Handle and spout for easy carrying and pouring control
- Built-in groove to drain filter

NEW 10836MI
Drain Container Replacement Plugs
For lost or stolen plugs



72 pk. (12 bags of 6)
For smaller quantities call: 800-835-0129



11837MI
10 Quart
Drain Container™

Updated cap reduces breakage & improves performance

6 pcs.
11837MI

OPEN STOCK CUT CASE OFF SHELF SIDE KICK PALLET TOPPER FLOOR DISPLAY

- Wide opening with screen to drain filter and capture the plug
- Built-in hand grips and pour spout for easy recycling
- Fully enclosed container provides a less mess oil change

NEW 10835MI
Drain Container Replacement Caps
Updated cap reduces breakage & improves performance



72 pk. (12 bags of 6)
For smaller quantities call: 800-835-0129



11845MI
5 Gallon
Drain Pan™

Updated cap reduces breakage & improves performance

4 pcs.
11845MI

OPEN STOCK CUT CASE OFF SHELF SIDE KICK PALLET TOPPER FLOOR DISPLAY

- Large capacity holds multiple oil changes
- Handle and spout for easy carrying and pouring control
- Oversized lip contains splatters



05080MI
Less Mess Drain Pan™

12 pcs.
05080MI

OPEN STOCK CUT CASE OFF SHELF SIDE KICK PALLET TOPPER FLOOR DISPLAY

- Extended profile catches full fluid flow
- 11 Quart capacity for less spilling
- Built-in filter drain stand



OP-1
7 Quart Drain Pan™

36 or 12 pcs.
OP-1 or OP-112

OPEN STOCK CUT CASE OFF SHELF SIDE KICK PALLET TOPPER FLOOR DISPLAY

- Built-in raised rim handles provide ease of use
- Drain scale helps track oil usage (1 to 7 quarts)
- Pouring spout makes recycling easier



Multiple Parts
Large Drip Tray™

12 pcs. 120 pcs.
DP-10 11430MI

OPEN STOCK CUT CASE OFF SHELF SIDE KICK PALLET TOPPER FULL PALLET

- Heavy gauge steel
- Large size - 25" x 36"
- No Spills, No Mess!™

FUNNELING HIGHER PROFITS

High Performance

The ultimate funnel incorporates best in class features AND helps the consumer get the job done quickly and easily. Our high performance funnels include no-mess splash guards, easy grip hand holds, speed channels and wide spout openings for high velocity pouring. Simply put, these funnels set the standard for fluid handling performance.

Task-Specific

FloTool has been the leader in developing high margin funnels that are specific to certain tasks, making fluid handling easier for the consumer. These include measuring and mixing, gasoline control, transmission fluid and more. Task specific products generate higher sales for you and higher satisfaction for the consumer.

Multi-Purpose

Our multi-purpose funnels include valuable step-up features like the no-mess splash guard or flexible spout to get to hard to reach filler holes. These middle price point items are essential step-ups for most planograms.

Basic

Basic funnels provide essential fluid handling benefits, usually bought by the budget-oriented consumer for small engine applications.

HIGH-PERFORMANCE



10705
Giant QuickFill® Funnel

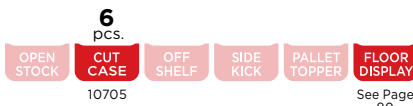

- Designed to hold large volume bottles
- Built-in hand hold for a better grip
- Filter screen included



05062MI
Super QuickFill® Funnel

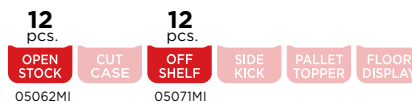

- Designed to hold one quart bottles
- Built-in hand hold for a better grip
- Extra wide neck for high speed pouring

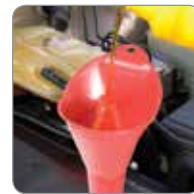

10718
QuickFill® Funnel

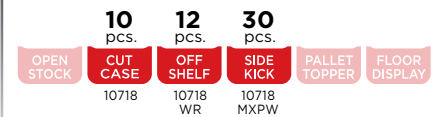

- Speed channels maximize flow rate
- Distinct hand hold for a better grip
- No-mess splash guard

TASK-SPECIFIC



10704
Measu-Funnel™

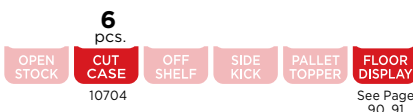

- Measures and pours
- On/off spout with tube and cap
- Easy grip handle for premixing



10711
Gas Gauge Funnel™

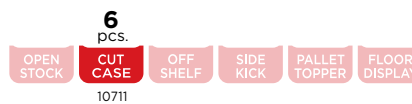

- Floating indicator signals when gas tank is full, helps prevent spills and overfills
- Great for lawn mowers and more
- No-mess splash guard



10716
Tight Spot Funnel™

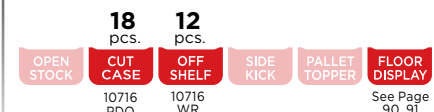

- Fits Where Other Funnels Don't™
- Ideal for tight engine compartments
- Molded hand-holds for a better grip

TASK-SPECIFIC



10721
2 Quart Funnel with Screen



- 2 quart capacity for large volume
- Filter screen included to clean fluids
- Built-in hang tab



10720
1 Pint Funnel with Screen

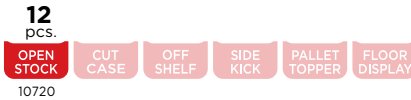

- 1 pint capacity, great for smaller engines
- Filter screen included to clean fluids
- Built-in hang tab



10719
Capless Gas Tank Funnel™

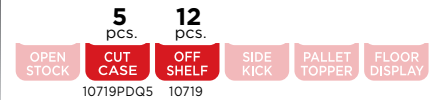

- For adding fuel additives or gas from portable containers to capless and restricted fuel fillers/tanks
- Flat spot allows use with CARB Compliant Spouts

TASK-SPECIFIC



10709
Locking Oil Funnel™

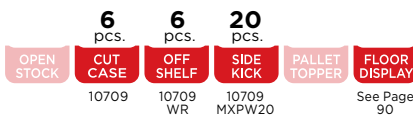

- Lock-in oil filler hole
- Funnel holds bottle while pouring
- No waste and no-mess quick pouring



06064MI
Transmission Funnel

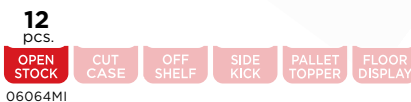

- 18" funnel made from durable high quality copolymer plastic
- Designed for hard to reach applications
- Perfect for transmission fluid



10703
Radiator Funnel™

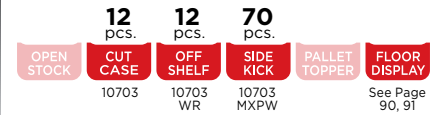

- Locks in most radiators
- No-mess splash guard
- Wide opening for quick pouring

MULTI-PURPOSE



10710
Multi-Task 5-in-1 Funnel™

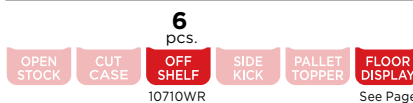

- Holds one quart oil bottle
- Three interchangeable spouts, including the Flexi-Spout
- Nestable



10712
Super Multi-Purpose Funnel™



- Large size (18") for multiple applications
- Perfect for transmissions and other engine fluids
- High perceived value allows for higher retail price points



05060MI
Flex Funnel™

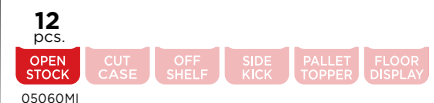

- Ideal for hard to reach applications
- Distinct hand holds for a better grip
- Detachable flexible spout

MULTI-PURPOSE



10701MX2
2-Piece Funnel Set

12 pcs.

OPEN STOCK	CUT CASE	OFF SHELF	SIDE KICK	PALLET TOPPER	FLOOR DISPLAY
------------	----------	-----------	-----------	---------------	---------------

10701MX2

- Multi-Purpose and Big Mouth funnel combo
- No-mess splash guards
- Covers all general purpose fluid applications



10701
Multi-Purpose Funnel™

12 pcs. 12 pcs. 40 pcs.

OPEN STOCK	CUT CASE	OFF SHELF	SIDE KICK	PALLET TOPPER	FLOOR DISPLAY
------------	----------	-----------	-----------	---------------	---------------

10701 10701 WR 10701 MXPW

See Page 90, 91

- No-mess splash guard
- Fits all sizes of filler tubes
- Extended filler neck opens gas tank trap door



10713
Big Mouth Funnel™

12 pcs.

OPEN STOCK	CUT CASE	OFF SHELF	SIDE KICK	PALLET TOPPER	FLOOR DISPLAY
------------	----------	-----------	-----------	---------------	---------------

10713

- No-mess splash guard
- Wide opening for quick pouring
- Notched bottle rest

BASIC



05034MI
Extra Large Funnel

12 pcs.

OPEN STOCK	CUT CASE	OFF SHELF	SIDE KICK	PALLET TOPPER	FLOOR DISPLAY
------------	----------	-----------	-----------	---------------	---------------

05034MI

- All purpose 18" funnel
- Great for hard to reach applications
- Tapered spout easily fits small reservoir openings



Multiple Parts
General Purpose Funnels

- 05007MI - Small Funnel (Gray) 72 pcs.
- 05015MI - Medium Funnel (Charcoal) 72 pcs.
- 05064MI - Large Funnel (Black) 12 pcs.
- 05068MI - 3-Piece Funnel Set - 12 pcs. (Includes small, medium & large funnels)



10106
Transmission Fluid/ Gear Oil Spout

12 pcs. 12 pcs.

OPEN STOCK	CUT CASE	OFF SHELF	SIDE KICK	PALLET TOPPER	FLOOR DISPLAY
------------	----------	-----------	-----------	---------------	---------------

10106B/6 10106WB

See Page 90, 91

- On/off adjustable flow spout
- Reduced tip for transmission filler tubes
- Fits quart or gallon containers



10101
Anti-Freeze/ Windshield Washer Spout

12 pcs. 18 pcs.

OPEN STOCK	CUT CASE	OFF SHELF	SIDE KICK	PALLET TOPPER	FLOOR DISPLAY
------------	----------	-----------	-----------	---------------	---------------

10101B/12 10101WB

See Page 90

- On/off valve
- Adjustable flow
- No Spills, No Mess!™



10107
No Spill Oil Spout™

12 pcs. 18 pcs.

OPEN STOCK	CUT CASE	OFF SHELF	SIDE KICK	PALLET TOPPER	FLOOR DISPLAY
------------	----------	-----------	-----------	---------------	---------------

10107B/12 10107WB

See Page 90

- Twist on, twist off
- No Spills, No Mess!™
- Adjustable built-in valve



10119
Super Flexi-Spout™

24 pcs.

OPEN STOCK	CUT CASE	OFF SHELF	SIDE KICK	PALLET TOPPER	FLOOR DISPLAY
------------	----------	-----------	-----------	---------------	---------------

10119B/24

See Page 90

- Works great for hard to reach areas
- Dual threading fits most quart and gallon containers
- Perfect for adding motor oil, anti-freeze, transmission and windshield washer fluid

FLUID TRANSFER MADE EASY

A six foot siphon with squeeze bulb is the most common siphon at retail today and the FloTool Super Siphon™ moves liquids up to 44% faster and is 4x easier to operate than other similar siphons. Don't be fooled by low cost imitations that are often nearly impossible to operate and become unusable in cold temperatures. If a high quality, value priced item is what you are looking for, the Hopkins Super Siphon is it.

Our Economy Siphon™ will easily transfer liquids and is perfect for the budget oriented consumer, while our step-up Shaker Siphon™ can make short work of a large job by moving up to 3.5 gallons per minute.

FloTool's line of fluid transfer items has now expanded to include the Multi-Purpose Transfer Pump™. With the ability to easily siphon or pump any liquid and also be used as an air pump or blower, this multi-purpose tool is perfect for any set.



10803 Multi-Purpose Transfer Pump™

6 pcs.

OPEN STOCK CUT CASE OFF SHELF SIDE KICK PALLET TOPPER FLOOR DISPLAY

10803

- Easily siphons or pumps any liquid
- Can be used as an air pump or blower
- Perfect for any gas can or fluid set



10801 Shaker Siphon™

6 pcs.

OPEN STOCK CUT CASE OFF SHELF SIDE KICK PALLET TOPPER FLOOR DISPLAY

10801

- Moves up to 3.5 gallons a minute
- 6 foot anti-static tube
- Perfect for home, auto, ranch, marine or farm



10800 Super Siphon™

6 pcs.

6 pcs.

OPEN STOCK CUT CASE OFF SHELF SIDE KICK PALLET TOPPER FLOOR DISPLAY

10800/6

10800X/6

See Page 90

- Clear tube to view liquid flow
- Safe and easy to use
- Perfect for transferring all types of liquids



10802 Economy Siphon™

6 pcs.

OPEN STOCK CUT CASE OFF SHELF SIDE KICK PALLET TOPPER FLOOR DISPLAY

10802

- 6' tube provides length for most jobs
- Easily transfers fluids
- Perfect for the budget oriented consumer



10111 MixMizer® Injector

6 pcs.

6 pcs.

OPEN STOCK CUT CASE OFF SHELF SIDE KICK PALLET TOPPER FLOOR DISPLAY

10111/6

10111X/6

- Measure and mix only what is needed
- Complete with extension tube
- Ratio scale takes the guesswork out of mixing oil and gas



11849MI Dispos-Oil™

4 pcs.

OPEN STOCK CUT CASE OFF SHELF SIDE KICK PALLET TOPPER FLOOR DISPLAY

11849MI

- 12 Quart capacity for multiple changes
- Container transports easily
- Molded handle and big mouth opening for easy carrying and pouring purposes



50863MI 6+ Gallon Water Can

6 pcs.

OPEN STOCK CUT CASE OFF SHELF SIDE KICK PALLET TOPPER FLOOR DISPLAY

50863MI

- Six gallon, 64 ounce capacity
- Self venting spout
- Top handle and back grip for easy carrying and pouring

PORTABLE FUEL FILTERS

YOUR TOOL FOR PURE FUEL

Dirt and water are the top reasons for fuel related engine failure

DIRTY FUEL IN PURE FUEL OUT

Pure Fuel Makes Any Engine Run Better And Last Longer

Dirt and water are practically unavoidable in stored fuel, causing corrosive acids, electrolysis, rust and more. These contaminants can plug filters, corrode components, decrease efficient combustion and cause engine shutdown or system failure.

You can combat these problems by refueling with a Portable Fuel Filter. Protect your engine by using this innovative product every time you transfer fuel to your tank.



Works With Gasoline, Diesel, Heating Oil and Kerosene

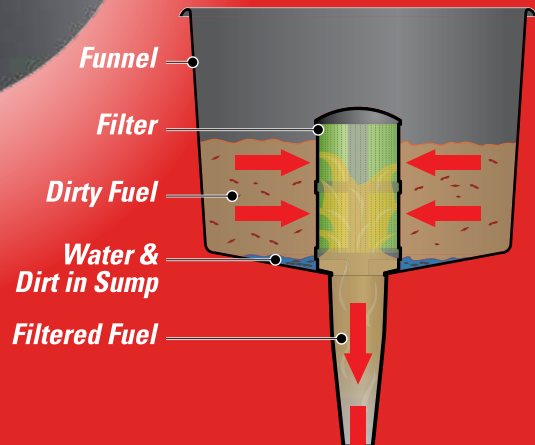

CHOOSE THE PORTABLE FUEL FILTER WITH THE FLOW RATE BEST SUITED TO YOUR CUSTOMERS' USE

FILTER	AGRICULTURE	INDUSTRIAL	MARINE	RECREATION	LAWN	GENERATOR
F15						
F8						
F3						
F1						

VALUE PRICED MODELS



F15C High Rate Conductive Portable Fuel Filter

4
pcs.



Flow Rate - 12 Gallons per minute
Diameter - 8.5 Inches
Height - 10 Inches



F8C Large Conductive Portable Fuel Filter

6
pcs.



Flow Rate - 5 Gallons per minute
Diameter - 8.5 Inches
Height - 10 Inches



F3NC Medium Non-Conductive Portable Fuel Filter

12
pcs.



Flow Rate - 3.5 Gallons per minute
Diameter - 5.5 Inches
Height - 9 Inches

See Page 91



F3C Medium Conductive Portable Fuel Filter

12
pcs.



Flow Rate - 3.5 Gallons per minute
Diameter - 5.5 Inches
Height - 9 Inches



F1C Small Conductive Portable Fuel Filter

12
pcs.



Flow Rate - 2.5 Gallons per minute
Diameter - 3.5 Inches
Height - 6 Inches



F1NC Small Non-Conductive Portable Fuel Filter

12
pcs.



Flow Rate - 2.5 Gallons per minute
Diameter - 3.5 Inches
Height - 6 Inches

See Page 91

Unique Filter Technology

When fuel is poured through a Portable Fuel Filter, water and debris will not pass through the filter's fluoropolymer-coated stainless steel filter. Only filtered fuel flows through to your engine, improving its efficiency, durability, and proper operation. The sump area collects the deflected water and debris for proper disposal.



E3 12" Flexible Spout

12
pcs.



E3

- Fill fuel at any angle
- Use with F3 models only

More Effective, Saves You Money!™

FloTool High Performance Absorbent™

FloTool High Performance Absorbent can absorb up to 8 times more liquid than traditional absorbents. The secret is how we heat-treat our wood fibers. It makes them far more effective than traditional clay and diatomaceous earth products. That's why FloTool High Performance Absorbent is the best value for the consumer. Our absorbent can be used on oil, grease, lubricant, paint, water, and other fluids and is safe to use on most surfaces including concrete, blacktop, turf, carpet, linoleum, tile, and more.

Save Half On Every Clean-Up

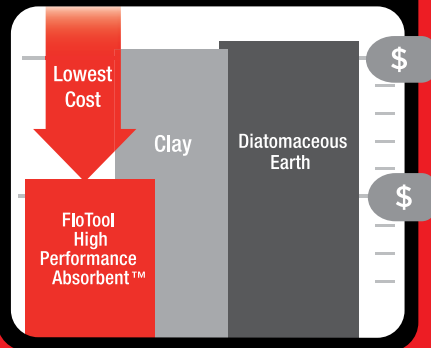

10201
FloTool High Performance Absorbent™ 25 lbs.

- 1 pc.
- OPEN STOCK
- CUT CASE
- OFF SHELF
- SIDE KICK
- PALLET TOPPER
- FLOOR DISPLAY

- 25 lbs. bulk bag for industrial use
- Instant one step clean-up
- Safer than traditional absorbents



10200
FloTool High Performance Absorbent™ 3 lbs.

- 8 pcs.
- OPEN STOCK
- CUT CASE
- OFF SHELF
- SIDE KICK
- PALLET TOPPER
- FLOOR DISPLAY

- Resealable bag for small spills
- Instant one step clean-up
- Safer than traditional absorbents



NEW
10202
FloTool High Performance Absorbent™ 3 oz.

- 12 pcs.
- 12 pcs.
- OPEN STOCK
- CUT CASE
- OFF SHELF
- SIDE KICK
- PALLET TOPPER
- FLOOR DISPLAY

- Convenient trial size bag for small spills
- Instant one step clean-up
- Safer than traditional absorbents



FLOOR SQUEEGEES

Keeping a floor clear of spills and slickness is essential, whether it is in the commercial or DIY setting. A high quality absorbent such as FloTool High Performance Absorbent™ will quickly stop the spread of spills and a Mallory floor squeegee will make clean-up a breeze. Choose from Commercial Grade oil resistant blades to general-purpose blades to foam blades, great on smooth surfaces.

Whatever the surface, whatever the fluid, Mallory floor squeegees get the job done right!



FLOOR SQUEEGEES

COMMERCIAL GRADE

Oil resistant

These oil resistant rubber blades have a higher tolerance to oil and other chemicals resulting in a longer blade life.

GENERAL PURPOSE

These general-purpose rubber blades work on all surfaces and with all fluids, perfect for the DIYer.

FOAM

A foam blade is ideal for smooth surfaces such as decks, patios, driveways, sidewalks and ceramic floors.

	KITS			HEADS ONLY		
	Part #	Description	Pcs.	Part #	Description	Pcs.
COMMERCIAL GRADE	841-24-116	24" Straight Red	2 pcs.	841-24	24" Straight Red	1 pc.
				841-30	30" Straight Red	1 pc.
				841-36	36" Straight Red	1 pc.
				844-24	24" Curved Red	1 pc.
	844-30-116	30" Curved Red	2 pcs.	844-30	30" Curved Red	1 pc.
				844-36	36" Curved Red	1 pc.
GENERAL PURPOSE	840-24-116	24" Straight Gray	2 pcs.	840-24	24" Straight Gray	1 pc.
				840-30	30" Straight Gray	1 pc.
				840-36	36" Straight Gray	1 pc.
	843-24-116	24" Curved Gray	2 pcs.	843-24	24" Curved Gray	1 pc.
				843-30	30" Curved Gray	1 pc.
	843-30-116	30" Curved Gray	2 pcs.	843-36	36" Curved Gray	1 pc.
FOAM	845-24-46	24" Straight	4 pcs.	845-24	24" Straight	4 pcs.
	846-30-54	30" Straight	3 pcs.	846-30	30" Straight	4 pcs.

KITS

Top selling heads complete with handles make it easy for consumers to shop the planogram.



HEADS ONLY

- Thick, pliable, non-marking rubber blades with industrial grade stamped steel sockets.
- Thick foam blades with zinc-plated steel heads and adjustable handle socket.



BLADE REFILLS

- 24" and 36" rubber refill blades
- Not available as a separate part for foam



HANDLES ONLY

- 54" hardwood handle with tapered tip
- 46" vinyl-coated steel handle with grip
- 54" vinyl-coated steel handle with grip and plastic threaded tip



BLADE REFILLS

HANDLES ONLY

Part #	Description	Pcs.	Part #	Description	Pcs.	
841R-24	24" Red	10 pcs.	116	54" Wooden Handle	10 pcs.	COMMERCIAL GRADE
841R-36	36" Red	10 pcs.				
840R-24	24" Gray	10 pcs.	116	54" Wooden Handle	10 pcs.	GENERAL PURPOSE
840R-36	36" Gray	10 pcs.				
Not Available for Foam			130-46 Blue	46" Vinyl Coated Handle	10 pcs.	FOAM
			154 Black	54" Vinyl Coated Handle	10 pcs.	

MERCHANDISING MENU

- OPEN STOCK
- CUT CASE
- OFF SHELF
- SIDE KICK
- PALLET TOPPER
- FLOOR DISPLAY

OFF SHELF / WIRE FIXTURES

Adding an extra ring or basket in the automotive set can increase sales by 20%

Part #	Description		Pcs.
10101WB	Anti-Freeze/Windshield Washer Spout	Wire Basket	18 pcs.
10106WB	Trans Fluid/Gear Oil Spout	Wire Basket	12 pcs.
10107WB	No Spill Oil Spout™	Wire Basket	18 pcs.
10701WR	Multi-Purpose Funnel™	Wire Ring	12 pcs.
10703WR	Radiator Funnel™	Wire Ring	12 pcs.
10709WR	Locking Oil Funnel™	Wire Ring	6 pcs.
10710WR	Multi-Task 5-in-1 Funnel™	Wire Ring	6 pcs.
10712WR	Super Multi-Purpose Funnel™	Wire Ring	12 pcs.
05071MI	Super QuickFill® Funnel	Wire Ring	12 pcs.
10716WR	Tight Spot Funnel™	Wire Ring	12 pcs.
10718WR	QuickFill Funnel™	Wire Ring	12 pcs.



OFF SHELF / CLIP STRIPS

Increase sales with clip-strips during key promotional seasons

Part #	Description	Pcs.
10202	High Performance Absorbent, 3 Ounce Bag	12 pcs.
10800X/6	Super Siphon	6 pcs.
10111X/6	MixMizer® Injector	6 pcs.
10719	Capless Gas Tank Funnel	12 pcs.





CUT CASES

Organize your planogram and boost holding power

Part #	Description	Pcs.
10119B/24	Super Flexi-Spout	24 pcs.
10701	Multi-Purpose Funnel	12 pcs.
10701MX2	2-Piece Funnel Set	12 pcs.
10703	Radiator Funnel	12 pcs.
10704	Measu-Funnel	6 pcs.
10705	Giant QuickFill Funnel	6 pcs.
10709	Locking Oil Funnel	6 pcs.
10710WR	Multi-Task 5-in-1 Funnel	6 pcs.
10711	Gas Gauge Funnel	6 pcs.
10712PDQ	Super Multi-Purpose Funnel	12 pcs.
10713	Big Mouth Funnel	12 pcs.
10716PDQ	Tight Spot Funnel	18 pcs.
10718	QuickFill Funnel	10 pcs.
05034MI	Extra Large Funnel	12 pcs.
10719PDQ5	Capless Fuel Tank Funnel	5 pcs.
10202PDQ12	High Performance Absorbent, 3 Ounce Bag	12 pcs.
11935MI	Easy Lift Rider Ramps	4 sets



SIDEKICKS

Add a sidekick during key promotional periods and increase sales by 40%

Part #	Description	Pcs.
10701MXPW	Multi-Purpose Funnel	40 pcs.
10703MXPW	Radiator Funnel	70 pcs.
10709MXPW20	Locking Oil Funnel	20 pcs.
10712MXPW	Super Multi-Purpose Funnel	20 pcs.
10718MXPW	QuickFill Funnel	30 pcs.



Free up valuable shelf space. FloTool® floor displays provide a one-stop consumer solution

Part	Description	Pcs.
10992	Rolling Wire Rack (Empty)	
10996RD	Display Product Includes:	
10101	Anti-Freeze/Windshield Washer Spout	12 pcs.
10106	Trans Fluid/Gear Oil Spout	12 pcs.
10107	No Spill Oil Spout	12 pcs.
10119	Super Flexi-Spout	24 pcs.
10701	Multi-Purpose Funnel	48 pcs.
10703	Radiator Funnel	24 pcs.
10704	Measu-Funnel	6 pcs.
10705	Giant QuickFill Funnel	6 pcs.
10709	Locking Oil Funnel	12 pcs.
10712	Super Multi-Purpose Funnel	12 pcs.
10714	Super Quick Fill Funnel	24 pcs.
10716	Tight Spot Funnel	24 pcs.
10717	Flex Funnel	6 pcs.
10800	Super Siphon	12 pcs.
OP-1	7 Quart Drain Pan	12 pcs.



(NOTE: Must order both 10992 and 10996RD to get rack and product)

Funnel Promo 2	Display Product Includes:	Pcs.
10106	Trans Fluid/Gear Oil Spout	12 pcs.
10701	Multi-Purpose Funnel	36 pcs.
10703	Radiator Funnel	36 pcs.
10704	Measu-Funnel	6 pcs.
10710	Multi-Task 5-in-1 Funnel	12 pcs.
10712	Super Multi-Purpose Funnel	24 pcs.
10714	Super QuickFill Funnel	24 pcs.
10716	Tight Spot Funnel	12 pcs.
10717	Flex Funnel	12 pcs.

(NOTE: Includes rack, all baskets and rings and product)



Part	Description	Pcs.
Funnel Promo 3	Display Product Includes:	Pcs.
10106	Trans Fluid/Gear Oil Spout	12 pcs.
10701	Multi-Purpose Funnel	36 pcs.
10703	Radiator Funnel	24 pcs.
10704	Measu-Funnel	6 pcs.
10710	Multi-Task 5-in-1 Funnel	6 pcs.
10712	Super Multi-Purpose Funnel	24 pcs.
10714	Super QuickFill Funnel	24 pcs.
10716	Tight Spot Funnel	12 pcs.
10717	Flex Funnel	12 pcs.
F1NC	Small Non-Conductive Fuel Filter	4 pcs.
F3NC	Medium Non-Conductive Fuel Filter	4 pcs.



11936MI
16-Set Rider Ramp
Floor Display





SAFETY ACCESSORIES



Simple, Safe and Ultra Secure™

The only booster cable with Cinch Lock™ technology ...
The most secure booster cable anywhere.



2013 AAPEX New Product Award Winner

Easily align ball to trailer every time using the only aftermarket camera with hitch mode.



Driver Awareness Solutions™

Making drivers safer with easy-to-install innovative solutions to common driving hazards ...

- Back-Up Safety
- Animal Alert
- Tire Safety





BOOSTER CABLES

SIMPLE, SAFE AND ULTRA SECURE

Whether it's your vehicle or you are being a good Samaritan, jump starting a battery is never a pleasant task. The most difficult and potentially dangerous part of the job is securely attaching the booster cable clamps to the battery posts.

Hopkins' patent pending Cinch-Lock™ Technology delivers unmatched clamping security.

- Cinch-Lock clamps provide 250% more clamping force, making a secure attachment both effortless and safe.
- To achieve a successful jump start, it's important to maximize the amps traveling through to the dead battery. Juice booster cables deliver up to 25% more amps than the competition.
- Juice booster cables include a full line of high quality cables, featuring Cinch-Lock clamps. Take advantage of an excellent opportunity to improve sales by moving customers up to a better performing product.



SUPERIOR INNOVATION WITH JUICE PERFORMANCE



Patent-pending Cinch-Lock™ ratcheting mechanism locks clamp to the battery terminal



Premium coated grip for secure handling and protection from shock





BC0860
Super-Duty Booster Cables
 20 Feet / 4 Gauge

4 pcs.

OPEN STOCK

BC0860

- 300% more power than 10 gauge cables
- Patent pending Cinch-Lock™ Technology for safer and easier jump starts



BC0825
Super-Duty Booster Cables
 12 Feet / 8 Gauge

6 pcs.

OPEN STOCK

BC0825

- 55% more power than 10 gauge cables
- Patent pending Cinch-Lock™ Technology for safer and easier jump starts



BC0840
Super-Duty Booster Cables
 16 Feet / 6 Gauge

6 pcs.

OPEN STOCK

BC0840

- 150% more power than 10 gauge cables
- Patent pending Cinch-Lock™ Technology for safer and easier jump starts



BC0800
Basic Booster Cables
 12 Feet / 10 Gauge

6 pcs.

OPEN STOCK

BC0800

- Standard cable clamps



Quick release button



Clamp provides 250% more clamping force

HASSLE-FREE HOOK-UPS!

2013 AAPEX NEW PRODUCT AWARD WINNER

The award winning Smart Hitch™ Camera and Sensor system eliminates the frustration of hitching up a trailer by yourself! The patent pending hitch mode easily aligns ball to trailer every time by placing an extra set of eyes where you need them.



Dual Mode display switches between hitch mode and everyday mode at the touch of a button.



EVERYDAY MODE



HITCH MODE

50002

SMART HITCH™ Camera and Sensor System

Made for towing

- Allows for one person to hitch by themselves

Plug-In Simple!®

- Camera mounts behind license plate
- No Splicing! Plugs in behind tow package connector
- Retains electrical functions at rear of vehicle

Crystal clear monitor

- Large, 3.5" color monitor with static free image

Great for everyday use

- Camera with SmartZone™ sensors
- 3 detection zones... Alerts distance and direction of objects

Exact OEM Fit™ and Plug-In Simple!® for the following vehicles



FORD		DODGE / RAM	
F-Series	1999-14	1500	2010-13
Expedition	1993-14	2500/3500	2010-13
Excursion	2000-05	CHEVY	
Explorer Sport Trac	2007-14	1500	2003-14
Flex	2009-14	2500/3500	1999-14
LINCOLN		Avalanche	2002-14
Aviator	2003-06	Tahoe	2000-14
Navigator	1999-12	Suburban	2000-14
Mark LT	2006-08	Colorado	2008-12
NISSAN		GMC	
Armada	2004-13	Yukon/XL/Denali	2000-14
Titan	2004-13	Canyon	2008-12

For vehicles not listed, simply splice to reverse light wire

INSTALLS IN 3 EASY STEPS



1 Place monitor in a desired location and route the wire to the rear of vehicle



2 Simply attach camera and sensor system behind license plate



3 Connect the Plug-In Simple!® harness to existing tow package connector

SMARTER THAN A CAMERA ...

Includes SmartZone™ Sensing

SmartZone™ Technology is the combination of sensors that detect the exact location of an object and a wide angle camera that allows the driver to see what is behind the vehicle

Easily mounts behind your license plate for optimal viewing ability.



Compact color monitor provides superior picture quality. Indicators on monitor let you know how close the object is to your vehicle



60195VA Rear View Camera and Sensor System

2
pcs.

OPEN
STOCK

60195VA

- Helps reduce blind spots and increase visibility
- Camera with sensors combination
- Works in all weather conditions, including at night
- Installs in 3 Easy Steps



60100VA
Back-Up Sensor System

2 pcs.
OPEN STOCK
60100VA

- Perfect for cars, trucks and SUV's
- Detects objects up to 5.5 feet away
- Easily mounts behind license plate



20195VA-CL-EN
Wireless Back-Up Sensor

2 pcs.
OPEN STOCK
20195VA-CL-EN

- Specifically designed for Cars, Trucks, Vans and SUV's
- Detects objects up to 6 feet away
- Compact LCD display shows exact distance and location of an object
- Wireless installation from bumper to dash of the vehicle
- Sensors simply attach to bumper



IDEAL FOR CONTRACTORS



Multiple Options
Back-Up Alert™

10 pcs. OPEN STOCK Multiple Parts
10 pcs. CLIP STRIP Multiple Parts

- Warns pedestrians as you back up
- Replace existing back-up bulb - easy to install
- Audible "beep-beep" sound when vehicle is in reverse

20100VA - Back-Up Alert® - 1156 (12 volt) Box
20101VA - Back-Up Alert® - 3156 (12 volt) Box
28700VA - Back-Up Alert® - 1156 (12 volt) Blister
28701VA - Back-Up Alert® - 3156 (12 volt) Blister



INCREASED NIGHT TIME VISION



Multiple Options
50 Watt Halogen Super-Bright Back-Up Bulb

10 pcs. OPEN STOCK Multiple Parts
10 pcs. CLIP STRIP Multiple Parts

- 250% brighter than standard back-up bulb
- Installation as easy as changing a light bulb
- Lifetime warranty

28706VA - 50 Watt Halogen -1156 (12 volt) Blister
28708VA - 50 Watt Halogen -3156 (12 volt) Blister



GREAT PROMOTIONAL OPPORTUNITY



TRAILBLAZER ELECTRONIC



DEER ALERT™

Making Drivers Safer With Animal Alerts



Deer accidents cause over \$1 Billion in damage every year. This premium Deer Alert is the perfect step-up at a suggested retail



3 PROMO OPTIONS IN 1 SKU!

27512VA
Trailblazer Electronic Deer Alert™

8 pcs.	8 pcs.	8 pcs.
OPEN STOCK	TRAY PACK	CLIP STRIP
27512VA	27512VA	27512VA

- Powerful electronic signal
- 10X safer than traditional deer whistles
- Easy installation ... Hidden from view
- Won't clog ... Keeps working

This product ships ready for display! Use the provided attractive tray or hang packages on the included clip strip



TIRE PRESSURE MONITORING SYSTEM SO SMART IT PAYS FOR ITSELF

EASILY INSTALLS
IN JUST MINUTES!

SAVES MONEY ON FUEL AND TIRES

It knows when your tire pressure is high or low, and even tells you when the tire temperature is hot. The right tire pressure maximizes fuel economy and tire life.

UNIQUE 4-POSITION MEMORY

Unlike other systems, nVISION lets you program different vehicles or trailers into memory. This means you can drop a trailer, or switch trailers at the touch of a button. No re-programming, no false alarms, no kidding!



SAFE TIRE CONDITIONS

- Properly inflated tires are safer, run cooler, last longer
- Helps increase fuel economy
- Increases tread life 50% or more

POOR FUEL ECONOMY ALERT

- Add air to tire at next convenient stop

DANGEROUS LOW PRESSURE ALERT

- Immediately get off road and air up tires
- 9-out-of-10 tire failures are caused by low tire pressure

HIGH PRESSURE ALERT

- Sends signal when tire is over-inflated
- Provides greater stability

HIGH TEMPERATURE ALERT

- Alerts when tires become too hot
- Hot tires increase the risk of blowout

5-LEVEL ALERT

Tire Pressure Monitoring System

FIELD REPORT:



nVISION TPMS was flawless and gave me great peace of mind and security as I logged those long hard miles. I have used this for 5000+ miles!

- Tom R. (NV)

Our unique "flip-top" monitor provides distraction free driving. With a touch of a button, the monitor opens to show you the exact tire(s) location and type of alert for that specific tire(s).



Pivoting antenna provides flexibility and owner can position for maximum signal strength. Pivots to fit into tight compartments in your RV.

30100VA

Tire Pressure Monitoring System

2
pcs.
OPEN STOCK
30100VA

Kit Includes:
1 - Monitor with non-skid pad,
1 - Power Cord, 1 - Pivoting Antenna,
1 - Quick-Set Installation Cord™,
4 - Tire Sensors

PERFECT FOR RV'ERS AND TOW'ERS

EASIEST TO INSTALL AND USE

- DIY...No professional installation required

MONITORS PROPER TIRE INFLATION AND TEMPERATURE

- 2 Stage Low Pressure Alert
- High Pressure Alert
- High Temperature Alert

MULTI-VEHICLE MEMORY

- 4 Programmable memory settings for different vehicles/trailers
- Monitors up to 24 tires simultaneously in each memory position

FULLY CUSTOMIZABLE

- Works on all sizes of tires up to 200 psi
- Monitor easily transfers between vehicles



30300VA
TPMS Repeater

1
pcs.

OPEN STOCK

30300VA

- Strengthens signals from sensors to the monitor
- Recommended for vehicles longer than 38 feet



30101VA
TPMS Sensor 2-Pack

6
pcs.

OPEN STOCK

30101VA

- Extra sensors for additional tires
- Compatible with 30100VA nVISION Tire Pressure Monitoring System

MERCHANDISING MENU

FREE SALES KIT WITH ANY nVISION TPMS PURCHASE



30500VA
nVISION TPMS
Sales Success Kit

(includes poster, 50 brochures, counter display, counter mat and window cling.)



800184002
TPMS Poster



8001837002
TPMS Brochure



8001841002
Window Cling



8001836002
TPMS Counter Mat



30400VA
TPMS Counter Display



Make It Any Size™

CUSTOMIZABLE DIY ORGANIZATION AND OUTDOOR FURNITURE KITS

DIY Projects Simplified

Our 2x4 Basics® brackets have been designed to make garage organization and outdoor furniture projects as simple as possible, from a heavy-duty workbench with shelves to a picnic table and matching chairs.

Only 90° cuts are required, no miters or angles, and projects can be built to any length up to eight feet. And to simplify the process even more, only 2x4 lumber is needed.

High Quality Products

Being made of heavy gauge structural resin, all 2x4 Basics brackets have a simple yet durable design allowing them to hold up to rough conditions.

Backed with a 2-year limited warranty, Hopkins continues to uphold the high standards in quality that do-it-yourselfers have come to expect and value from 2x4 Basics products.





DIY INSPIRATION



90110MI
Flip-Top Table™

SAND

1

set
OPEN STOCK

90110MI

- Converts from bench to table using patented slide-lock feature
- Convert two benches to make table that seats eight



90134MI
AnySize Chair™

SAND

1

set
OPEN STOCK

90134MI

- Build a two foot chair up to an eight foot bench
- Includes integrated beverage holders



90140MI
AnySize Table™

SAND

1 set

OPEN STOCK

90140MI

- Determine the size to suit your needs
- Versatile application makes coffee table, foot rest, bench and more up to eight feet



90152MI
Patio Table

SAND

1 set

OPEN STOCK

90152MI

- Make a table of any length up to eight feet
- Made of durable and maintenance-free structural resin



90182MI
Picnic Table Kit

SAND

1 set

OPEN STOCK

90182MI

- Makes a set of table and chairs up to eight feet
- Comes with Patio Table brackets and two AnySize Table sets



Multiple Parts
Dekmate™ Bench Bracket

BLACK

12 pcs.

OPEN STOCK

90170MI

2 pc. set

CATALOG ONLINE

90172MI

- Can be used with new and existing decks
- Space saving design



Multiple Parts
Dekmate™ Bench Bracket

SAND

12 pcs.

OPEN STOCK

90166MI

2 pc. set

CATALOG ONLINE

90168MI

- Can be used with new and existing decks
- Space saving design



Multiple Parts
Dekmate™ Bench Bracket

REDWOOD

12 pcs.

OPEN STOCK

90174MI

2 pc. set

CATALOG ONLINE

90176MI

- Can be used with new and existing decks
- Space saving design



DIY MADE EASY



Multiple Parts ShelfLinks™

BLACK

6 sets 30 pcs. 1 set
6-packs open stock 6-pack

OPEN STOCK

OPEN STOCK

CATALOG ONLINE

90128MI 90120MI 90124MI

- 16" deep shelves made of heavy gauge structural resin
- Can be modified or expanded as storage requirements change



Multiple Parts ShelfLinks™

SAND

6 sets 30 pcs. 1 set
6-packs open stock 6-pack

OPEN STOCK

OPEN STOCK

CATALOG ONLINE

90126MI 90116MI 90118MI

- 16" deep shelves made of heavy gauge structural resin
- Can be modified or expanded as storage requirements change



Multiple Parts Firewood Rack - 2 pack

BLACK

12 Sets 1 set
OPEN STOCK CATALOG ONLINE

90142MI 90144MI

- Any size up to eight feet
- Use two kits and create a multi-layer or multi-section structure



90158MI WorkBench Kit

BLACK

1 set
OPEN STOCK

90158MI

- Build a heavy-duty workbench up to four feet wide and eight feet long
- Middle shelf can be left out to store larger items



90164MI
WorkBench Kit
with ShelfLinks™

BLACK

1
set
 CATALOG
ONLINE
 90164MI

- Heavy-duty workbench and ShelfLinks create the ultimate workspace
- Kit includes four Workbench legs and six 16" ShelfLinks



90101MI
StudTrack™

BLACK

4 sets
OPEN STOCK
90101MI

1 set
CATALOG ONLINE
90101MI

- Organize long-handled tools, electric cords or sporting equipment
- Includes two end brackets and six universal hooks



Multiple Parts
Pro Brackets™
Sawhorse - 2 pack

BLACK

4 sets
OPEN STOCK
90194MI

2 sets
CATALOG ONLINE
90196MI

- Great for professionals or do-it-yourselfers
- Customize to fit your need - three, four or five feet



90190MI
Barn Roof Shed Kit

Plans Included

3 pcs.
OPEN STOCK
90190MI

1 pc.
CATALOG ONLINE
901901MI

- No angled cuts — saves time and money!
- One kit builds a shed up to 10 feet, combine kits for a shed up to 22 feet



90192MI
Peak Roof Shed Kit

Plans Included

4 pcs.
OPEN STOCK
90192MI

1 pc.
CATALOG ONLINE
90192MI

- No angled cuts — saves time and money!
- One kit builds a shed up to 10 feet, combine kits for a shed up to 22 feet





Making The Towing Experience Simpler And More Rewarding Through Innovation And Value

This is our mission and passion. Hopkins Towing Solutions® is the brand that is engineered for ease of use and is built to last. As the leader and #1 brand of DIY electrical towing products, it is our duty to enhance the user towing experience while providing incremental sales opportunities for our customers.

Inside this product guide, you will find innovative and superior towing electrical products, helpful charts, wiring codes and application guides.

If you need assistance installing a product, or have questions regarding a Hopkins Towing Solutions and we are prepared to support you throughout the product ownership experience.

Be sure to look at the new products we are introducing for 2014. We are confident you will be satisfied with your experience.





VEHICLE SIDE



ADAPTERS



TRAILER SIDE



LEVELS



BRAKE CONTROLS



ACCESSORIES

INDEX

PART	PAGE
4-10NY-E	34, 35
8NY-16A	35
8NY-24A	35
8NYE-48	34
10NY-24A	35
12-8NY-48	35
12-808NY	36
12-810NY	36
24-808NY-30A	35
100	
110	36
111	36
112U	36
115-4	36
115-6	36
115-8	36
116	36, 87
118-54	36
130-46 Blue	87
148	36
154 Black	87
160	36
200	
203	62
300	
511-E	64
523	62
524-532	61
532	61
577-EPKUS	65
580-EP	64
581-E	64
583-EP	63
800	
806NY	34
840-24	86
840-24-116	86
840-30	86
840-36	86
840R-24	87
840R-36	87
841-24	86
841-24-116	86
841-30	86
841-30-116	86
841-36	86
841R-24	87
841R-36	87
843-24	86
843-24-116	86
843-30	86
843-30-116	86
843-36	86
844-24	86
845-24	86
845-24-46	86
846-30	86
846-30-54	86
885	34
886 PKUS	65
900	
994PKUS	65
994PKUS	68, 69
996-35	61
999-CT	60
1000	
1124F	58, 68
1210XM	64
2248FD	62, 69
2610FD	64, 69
2610XB	64
2610XM	64
2672XM	64, 69
3248	69
3512PBT	63, 68
3518FD	61, 69
3610XM	64
3648	69
05007MI	80
05015MI	80
05034MI	80, 89
05060	90, 91

PART	PAGE
05060MI	79
05062MI	78
05064MI	80
05068MI	80
05071MI	78
05080MI	77
5412PBT	63, 68
5420FD	69
06064MI	79
9000R	36
9003R	36
9005R	36
9007R	36
9008BLK	36
9010R	35
9014R	35
9020A	34
9025CDF	34, 37
9031R	35
9032R	35
9033R	36
9037R	35
9038	34
9039R	35
9045R	34
9046	35
9049	34
9050	36
9051	36
9053	35
9056	35
9057	35
9058	35
9217Blk	36
9221Blk	36
9260	36
9262	35
9262B	35
9263	35
9266	35
9267	35
9271X	5, 32
9272X	5, 32
9425CDX	5, 32, 37
9438X	5, 32, 37
9500	34
9501	36
9507	36
9508	36
9514	36
10101	80, 90
10000	
10101WB	80, 88
10106	90, 91
10106B/6	80
10106WB	80, 88
10107	80, 90
10107B/12	80
10107WB	80, 88
10111	81
10111/6	81
10111X/6	81
10119	80, 90
10119B/24	80, 89
10200	84
10200PDQ12	84
10201	84
10202	7, 84
10202PDQ12	89
10601	75
10601B/12	75
10609	75
10609B/12	75
10614	75
10614B/6	75
10615	75
10615B/6	75
10617GT	74
10619	75
10620GT	74
10621GT	74
10622GT	74
10627GT	75
10630	75

PART	PAGE
10631GT	75
10632GT	74
10633GT	74
10634GT	74
10701	80, 89, 90, 91
10701MX2	80, 89
10701MXPW	80, 88, 89
10701WR	80, 88
10703	79, 89, 90, 91
10703MXPW	79, 89
10703WR	79, 88
10704	78, 89, 90, 91
10705	78, 89, 90
10709	79, 89, 90
10709MXPW20	79, 88, 89
10709WR	79, 88
10710	79, 90, 91
10710PDQ	89
10710WR	79, 88
10711	78, 89
10712	79, 90, 91
10712MXPW	79, 88, 89
10712PDQ	79, 89
10712WR	79, 88
10713	80, 89
10716	78, 90, 91
10716PDQ	78, 89
10716WR	78, 88
10717	90
10718	78, 89
10718MXPW	78, 88, 89
10718WR	78, 88
10719PDQ5	89
10800	81, 90
10800/6	81
10800X/6	81
10801	81
10802	81
10803	81
10835MI	7, 77
10836MI	7, 77
10992	90
10996RD	90
11000	
11430MI	77
11837MI	77
11838MI	77
11845MI	77
11849MI	81
11909MI	73
11912MI	73
11930MI	73
11933MI	73
11935MI	73
11936MI	73
12000	
12201	66, 68
12212	66, 68
12324	66, 68
12360	66, 68
12501	66
12550	7, 66
13000	
13014	58, 68
13024	61
13025	61, 68
13044	58
13054	60
13055	69
13058	58, 68
13059	60, 68
13781	61, 68
13920	58, 68
13920CS	58, 68
13929	58
14000	
14013	59, 68
14014	61, 68
14015	63, 68
14026	63, 68
14035	63, 68
14038	63, 68
14039	63, 68

PART	PAGE
14403	63, 68
15000	
15275	68
15285	68
15295	66, 68
15511	58, 68
15613	61, 68
15781	62
16000	
16024	61, 68
16211	59, 68
16250	59, 68
16511	61, 68
16528	61, 69
16619	63, 68
16620	60, 68
16621	59, 68
16721	59, 68
16738	59, 68
17000	
17211	67, 68
17221	67, 68
17228	67, 69
17268	67, 69
17297	69
17511	66, 68
17529	66
18000	
18424	59, 68
18520	7, 60
18833	64
18837	64, 69
18841	64
18845	64, 68
18847	64, 69
18849	65
19000	
19518	62, 69
19520	62, 68
19618	61, 69
19621	61
20000	
20100VA	98
20101VA	98
20195VA-CL-EN	98
23110Q	61, 69
26120	64, 69
27512VA	99
28700VA	98
28701VA	98
28706VA	98
28708VA	98
30000	
30100VA	100
30101VA	101
30300VA	101
30400VA	101
30500VA	101
35180	61, 69
40000	
40046	30
40046D	30, 37
40047	30
40047D	30, 37
40048	30
40050	30
40050D	37
40051	30
40052	30
40059	19
40059AS	19
40061	28
40061D	28, 37
40062	28
40062D	28, 37
40064	29
40065	30
40065D	30, 37
40067	30
40067D	30, 37
40069	30
40071	30

PART	PAGE
40102	27
40102D	27
40106	27
40107	27
40110	27
40112	27
40112D	37
40112PDQ	27
40118	30
40119	30
40120	30
40122	30
40122D	30, 37
40123	29
40123D	29, 37
40125	29
40200	19
40201	19
40202	19
40203	19
40204	19
40205	19
40206	19
40208	29
40209	29
40210	29
40211	29
40302	26
40304	26
40305	18
40306	26
40307	26
40309	26
40310	26
40313	27
40314	27
40400AS	13
40401AS	13
40402AS	13
40403AS	13
40404AS	13
40405AS	13
40406AS	13
40407AS	13
40408AS	13
40409AS	13
40410AS	13
40411AS	13
42000	
42004MI	76
42008MI	76
45000	
45010	29
45010D	29
45054	30
45062	28
45063	28
45066	28
45067	28
45069	28
45070	28
45078X	5, 33, 37
45114	27
45116X	5, 33, 37
45117	27
45119	27
45122X	5, 33
45133	18
45135	18
45137X	5, 33
45163	28
45211	28
45214	29
45218	31
45320	26
45401AS	13
45544X	5, 33, 37
45602	18
45602AS	18
45604	18
45604AS	18
45606	19
45606AS	19



INDEX

PART	PAGE
45610	18
45610AS	18
45617AS	31
45619X	5, 33
45625	19
45625AS	19
45630	19
45630AS	19
50000	
50863MI	81
60000	
60100VA	98
60195VA	97
60197VA	7
70000	
79000	44, 45
79080	6, 55, 91
80000	
80037	62
90000	
90005	21
90015	21
90016	20
90042	21
90043	6, 20
90049	21
90049D	21, 37
90051	20
90051D	20, 37
90063	6, 20
90101MI	107
90110MI	104
90116MI	106
90118MI	106
90120MI	106
90124MI	106
90126MI	106
90128MI	106
90134MI	104
90140MI	105
90142MI	106
90144MI	106
90152MI	105
90158MI	106
90164MI	107
90166MI	105
90168MI	105
90170MI	105
90172MI	105
90174MI	105
90176MI	105
90182MI	105
90190MI	107
90192MI	107
90194MI	107
90196MI	107
92000	
92004	17
92010	16
92010D	16, 37
92011	16
92012	16
92012D	16, 37
92014	16
92016	25
92017	24
92017D	24, 37
92018	16
92019	25
92019WR	25, 37
92022S	22
92025	16
92034	17
92036	16
92036D	16, 37
92042WR	37
92043	25
92043WR	25, 37
92046	25
92046WR	25, 37
92047WR	37
92049	17

PART	PAGE
92052	17
92215	21
92215D	21, 37
92216	21
92216D	21, 37
92217	21
92217D	21, 37
92508	36
92509	36
92510	36
92511	36
93000	
93006	31
93007	31
93008PC	31
93012	24
93018	24
93019	25
93025	24
93025D	24, 37
93027	24
93028	25
93034	25
93036	24
93036D	24, 37
93039	24
93043	25
93043WR	25, 37
93044	25
93047	24
93052	22
93053	23
93053D	37
93055	22
93058	23
93058D	37
93060	23
93060D	23, 37
93062	23
93062D	23, 37
93069	36
93072	14
93072D	14, 37
93089	22
93089D	22, 37
93097	15
93097D	15, 37
93112	25
93303	15
93303D	15, 37
93501	36
93502	36
93504	36
93977	15
93977D	15
93984	15
93984D	15, 37
93986	14
93986D	14, 37
94000	
94000AS	12
94001AS	12
94005AS	12
94012	24
94018	24
94025	24
94036	24
94037	24
94039	24
94101	34
94102	20
94108VA	6, 20
94109VA	6, 20
96000	
96100	37
97000	
97370AS	17
97371AS	12
97372AS	17
97373AS	17
450000	
458617AS	31

PART	PAGE
900000	
901011MI	107
901901MI	107
901921MI	107
1200000000	
1220702013	54
1220702053	54
1220715013	54
1220715053	54
8000000000	
8001836002	101
8001837002	101
8001840002	101
8001841002	101
A	
ASH-COIN	54
B	
BACKORG	47
BACKPLUS-BLA	46
BC0800	95
BC0800PDQ	95
BC0825	95
BC0825PDQ	95
BC0840	95
BC0840PDQ	95
BC0860	95
BC0860PDQ	95
BENCH-BLA	48
BENCH-CHA	48
C	
CARGO-BLA	54
CARGO-BLA-2	47
CARGO-CAR-PDQ	54
CENTER-BLA	46
CMPTORG-BLA-PDQ	54
CMPTPLUS-BLA	46
CNSLPLUS-BLA	46
D	
D8-577-EPKS	69
D8-16024	65
D24-886	65
D24-886PKUS	69
DP-10	77
DWR20	69
DWR48	69
DWR120	69
DWR136	69
DWRBRUSH2	69
E	
E3	83
EDWR-6	69
EFF-BLA	48
EFF-CHA	48
EFF-CHA/PDQ	54
EMIC-BLA	48
EMIC-CHA	48
F	
F1	82
F1C	83
F1NC	83
F3	82
F3C	83
F3NC	83
F8	82
F8C	83
F12-581-E	64, 69
F14-583-EP	63, 69
F15	82
F15-580-EP	64, 69
F15C	83
F16-511-E	64, 69
F20-532	61, 69
F20-996-35	61, 69
F24-523	62, 69
FULLORG-BLA-PDQ	54
G	
GOBAND	47, 54
M	
MINIORG	46
N	
NBCF-13920	65, 68

PART	PAGE
NBCF-14026	65, 68
NBCF-16024	65, 68
O	
OP-1	77, 90
OP-112	77
OTS2-BLA-PDQ	54
R	
RETRO-CHA	49
RETRO-CHA-PDQ	49
S	
S12-16024	65, 68
S18-518	62, 68
S24-523	58, 62, 68
S24-527PKUS	65, 68
S24-532	68
S30-886	65, 68
SC-BLA	48
SC-CHA	48
SEJ	49
SMT	49
SP120201J	50
SP120201S	50
SP120403J	51
SP120403S	51
SP120605J	51
SP120605S	51
SP120620J	51
SP120620S	51
SP120901FD	55
SP120901J	50
SP120901JFD	55
SP120901S	50
SP120901SFD	55
SP120903J	51
SP120903S	51
SP120905FD	55
SP120905J	51
SP120905S	51
SP120912	7
SP120912FD	55
SP120912J	51
SP120912S	51
SP120916	7
SP120916FD	55
SP120916J	51
SP120916S	51
SP120920FD	55
SP120920J	51
SP120920JFD	55
SP120920S	51
SP120920SFD	55
SP130801J	50
SP130801S	50
SP130802J	50
SP130802S	50
SP130901FD	55
SP130901J	50
SP130901JFD	55
SP130901S	50
SP130901SFD	55
SP130902J	50
SP130902JFD	55
SP130902S	50
SP130902SFD	55
SP240401J	52
SP240401JFD	52, 55
SP240401P	52
SP240401S	52
SP240401SFD	52, 55
SP240603J	52
SP240603JFD	52, 55
SP240603S	52
SP240603SFD	52, 55
SP240612J	52
SP240612JFD	52, 55
SP240612S	52
SP240612SFD	52, 55
SP240620J	52
SP240620JFD	52, 55
SP240620S	52
SP240620SFD	52, 55
SP240912	7
SP280804R	52

PART	PAGE
SP570804	53
SP571204	53
SP2603041	53, 54
SP2605042	53
SP2605042CS	53, 54
SP2605042SK	53, 54
SP2805042	53
SP2805042CS	53
SP2805042SK	53, 54
SP3503041	53
SP4605041	53
SSC-BLA/DLX	48
SSC-CHA/DLX	48
T	
TOWER-BLA	46
TRASH10-BLA	49
TRASH10-BLA-CS	49, 54
TRASH13-BLA-CS	49, 54
TRASH13-BLA-PDQ	49, 54
TRASH-BLA	49
TRASH-BLA-CS	49, 54
TRASH-BLA-PDQ	49, 54
TRU-BLA-PDQ	47, 54
U	
UNDERORG	47
V	
VENT-05	47
VENT-05-CS	47, 54
VENT-05-SK	47, 54
VENT-10	47
VENT-10-CS	47, 54
VENT-10-SK	47, 54
VSR	49
VSR-10	49
VSR-20	49
W	
WS1524	36
WS1524A	35
WS1524U	35
WS2024	36
WS2024A	35
WS2024U	35
WS4212	36
WS4224U	35
WSE-39A	35
WSH24	36