

PRO PRODUCTS

- Intake Manifolds
- Harmonic Dampers
- Fuel Injection Systems
- Fuel System Components
- Distributors & Ignition
- Engine Accessories
- Throttle Bodies

2016 Full Line Catalog



Professional Products® 2016 Catalog Index

Powerjection™ EFI Systems

Powerjection™ & EFI Components Pages 3-7

Powerfire VI CDI

Powerfire VI CDI Page 8

Powerfire Distributors & Coils

Powerfire Distributors & Coils Pages 9, 10

Power+Plus® Intake Manifolds

GM LS1, LS2, LS6 Pages 11, 12, 16

Small Block Chevrolet Guide Pages 13

Small Block Chevrolet Pages 14, 15, 16

Big Block Chevrolet Page 17

Small Block Ford Page 18, 19

5.0L Ford V8 Page 19

4.6L 2V Ford V8 Page 19

Small Block Chrysler Page 20

Pontiac V8 Page 20

Oldsmobile V8 Page 20

Acura Type R, GSR Page 21

Intake Manifold Features Page 21

EFI Manifolds Page 22

Manifold Technical Specifications Page 23

Engine Accessories & Intake Manifold Accessories

Pro Drive Accessory Kits for SB Chevy Page 24

12-Point Stainless Bolt Kits Page 25

Airflo™ Power Enhancer Page 25

Upper Plenum & Elbow Adapter Page 25

Throttle Cable Bracket Kits Page 25

Gaskets Page 26

EGR Adapter, Carb Adapters Page 26

4.6L to 5.4L Adapter Plates Page 26

Carburetor Stud Kits Page 27

EFI Snorkle Inlet & Carb Adapters Page 27

SB Chevy Water Pumps Page 27

Powerfilter™ Oil Filters Page 28

Powerflow Fuel System Components

In-Tank Fuel Pump Modules Page 29

Ford Throttle Bodies Page 30

GM Throttle Bodies Page 30

Acura Throttle Bodies Page 30

Powerflow™ Fuel Rail Kits, Ford & GM Page 31

Powerflow™ Fuel Rail Kits, Acura Page 27

Powerflow™ Fuel Pressure Regulators Pages 32, 33

Street Fuel Filters Page 34

Competition Fuel Filters Page 34

Carburetor Inlet Kits Page 35

EFI Fuel Pumps Page 35

Powerforce™ & Powerforce+Plus™ Harmonic Dampers

Features and benefits Page 36

Application Listing with weights Page 37

Harmonic Damper Technical Notes Page 38

SB Chevy Page 39

BB Chevy Page 39

GM LT1 Page 39

GM LS3 Page 39

GM LS1, LS2 & L92 Page 40

SB Ford Page 40

429-460 Ford, FE Ford Page 40

4.6L 2V & 4V Ford Page 40

4.6L 3V Ford Page 40

5.0L 4V Ford Mustang Coyote Page 41

SB and BB Chrysler plus late Hemi Page 41

Dodge Viper Page 41

Pontiac Page 41

Oldsmobile Page 41

AMC, Jeep Page 41

Honda, Acura, & Nissan Pages 41, 42

Harmonic Damper Accessories Page 43

Tire Gauges & Other Assorted Gauges

Gauges Page 42

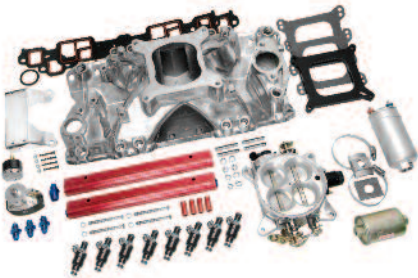

Left - This is a photo of our Powerjection+Plus for a small block Chevy. This demonstrates the completeness of one of our kits with everything needed included. Powerjection+Plus port injection systems on page 5 and 6.

Emission Codes

Professional Products, as well as other SEMA manufacturers, have adopted a series of color coded symbols that are used throughout the catalog to identify emission-sensitive products and to make the necessary information

available to consumers regarding the various uses that individual products will have related to any emissions regulations. Please review these symbols and their explanations as shown below.



The product marked with this symbol has been granted a California Air Resources Board (CARB) exemption, an "EO" number, or is a direct or consolidated replacement part. It is 50-state legal per the manufacturer's application guide. (Must be used on listed applications for that part to be legal.)



The manufacturer of the product marked with this symbol represents that it has not been found, nor is believed to be, unlawful for use under provisions of the clean air act, per the manufacturer's application guide. This product is not legal for sale or use in the state of California, or in states which have adopted the CA emissions standards, except on pre-emission controlled motor vehicles/motor vehicle engines (pre-1966 model years).



The product marked with this symbol is legal only for off-highway use (except in CA or states which have adopted CA emission standards), racing use or for use on pre-emission controlled motor vehicles/motor vehicle engines (pre-1966 domestic vehicles certified to CA standards, pre-1968 domestic vehicles certified to federal standards, and all pre-1968 foreign vehicles, per the manufacturer's application guide.

SPECIAL NOTE: Throughout this catalog original equipment brand names are used such as Chevrolet, Ford, Buick, etc. None of the products in this catalog are manufactured or offered by any of those companies. The listed products are all manufactured by Professional Products and no connection to any O.E. manufacturer is intended or implied.

Powerjection™ EFI The Pioneer Self-Tuning EFI System

Powerjection EFI systems are complete and fully programmable replacement EFI systems. Powerjection incorporates some of the most impressive feature sets available for the do-it-yourself hobbyist or pro-fessional shop. Powerjection consists of two distinct styles: Powerjec-tion III is a throttle body style carburetor replacement EFI system with the EMS integrated into the throttle body for the hot-rodder who wants the look of a carburetor. Powerjection+Plus is a port fuel injection sys-tem with the EMS mounted on the manifold. Powerjection+Plus is de-signed for those who desire port fuel injection and/or very high horsepower capability. To the driver who is unaware what is under the hood there will be no discernable difference in the way the car drives with either system. We use interchangeable components that are OEM grade. We offer both designs to meet the needs and desires for the do-it-yourselfer.

Here are some of the features shared by all of our systems:

- Adaptive Learning EMS. While driving, the system will adapt to your engine. The EMS is laptop programmable for the ultimate in tuning capability.
- Spark Timing Control integrated into the EMS for optimum engine management.
- Fully compatible with the Powerfire VI CDI.
- A returnless option (**FuelOnDemand** 70035) is available for all kits. This eliminates the time consuming and sometimes difficult task of installing a return line to the fuel tank. Provides fuel delivery control.
- No-weld oxygen sensor installation – drill a hole and install the clamp and sensor.
- Installation time is less than a day on all of our systems.

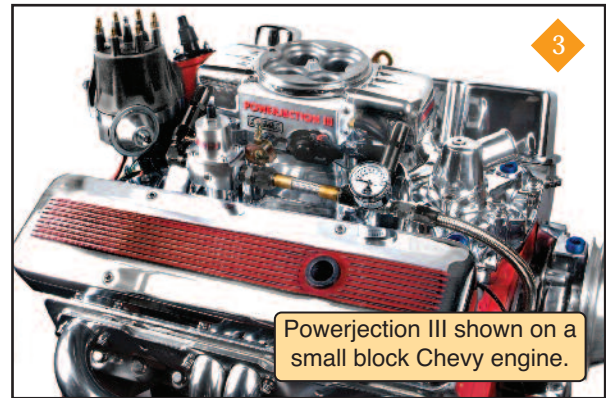

ABOVE - This is the POWERJECTION III on an engine. While the throttle body looks like a carburetor, it is actually a fully self contained throttle body that includes four port style injectors, fuel rails, idle air control, MAP sensor, and throttle position sensor.

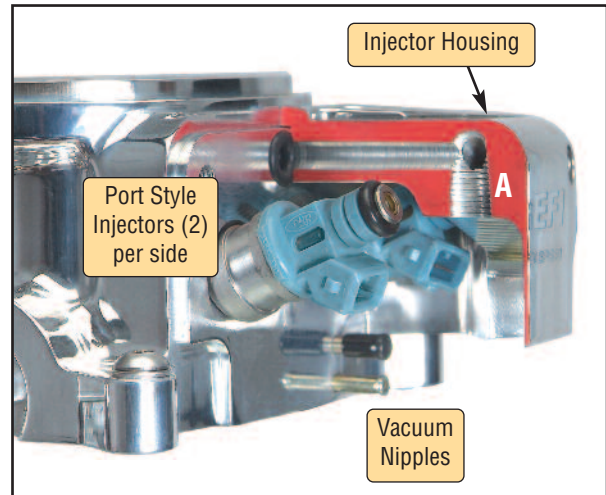

Above - This cutaway shows how the part that looks like a carb float bowl is actually an injector housing. The two fuel inlets in the two end cap housings are threaded to accept a Professional Products Fuel Inlet Kit which is supplied with the Powerjection III kits. On systems using the Fuel Control Module to provide the returnless feature, the fuel pressure sensor threads into the tapped hole marked "A" above. The throttle body assembly incorporates the EMS (computer), idle air control (IAC) and the MAP sensor all into one compact unit.

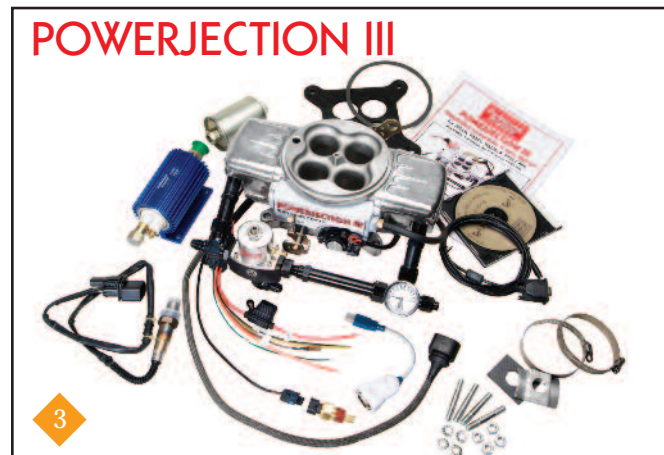

POWERJECTION III

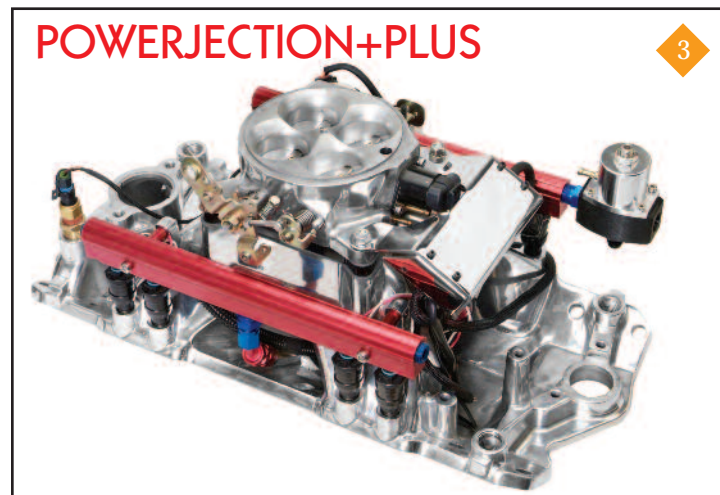

POWERJECTION+PLUS

Left - This photo shows the Powerjection+Plus complete Port EFI System. We have integrated the ease and streamlined installation of the Powerjection III into a complete port fuel injection system. This system is capable of supporting up to 800 horsepower.

The Powerjection+Plus is a complete system - including an adaptive learning Engine Management System, intake manifold, fuel rails and injectors, 1200 CFM throttle body, harnesses, sensors, fuel pump and filter - basically all the parts needed to install fuel injection on your high horsepower engine.* The Powerjection+Plus is completely tunable via a laptop connection.

The Powerjection+Plus EMS includes an ignition driver that fires the coil. When used with a two-wire distributor, an aftermarket ignition box is not required.

Powerjection+Plus systems are available for small block and big block Chevrolet V8s plus small block and 351W Ford V8 engines. Pontiac and Oldsmobile applications are available on special order.

**Installation may require some fittings, electrical connections and fuel lines. Fuel Line Kits are available. See page 5.*

EFI Fuel Pump and Filter

U.S. Patent #7,735,475

Wideband O₂ is standard on all of our EFI Systems

Engine Management System - Includes TPS, MAP, and IAC. Eliminates an extensive amount of wiring.

Installation/User Manual and Dashboard Software

Harness for ignition switch, fuel pump, battery, and coil.

O₂ Sensor Bung, Gasket & Clamps. No welding required

O₂ Sensor Cable

Coolant Sensor and harness

Fuel Inlet Kit with Fuel Pressure Regulator and Gauge

Longer Carb Studs, Nuts & Washers

70027 Kit shown, 70026 is same except it has a satin finish.

This is the Complete EFI kit. No other parts required.

What you see in the photo at left is the Complete Kit.

KEY FEATURES:

- The Powerjection III pioneered the self learning feature for aftermarket EFI systems. To match the Powerjection III's tunability in any of the brand name EFI kits you will spend hundreds more.
- Carburetor replica throttle body for that traditional hot rod look.
- ECU mounts on the throttle body eliminating most of the wiring on other systems. No need to cut holes in the firewall for a harness.
- Utilizes wideband O₂ sensor for optimum tuning feedback.
- 2.5 BAR MAP sensor integrated into the EMS measures up to 25 PSI boost for supercharged/turbocharged apps. Many other competing aftermarket throttle body systems lack this feature.
- Idle Air Control, Fuel Pressure Sensor (when utilized), Throttle Position Sensor and MAP Sensor all contained in throttle body assembly.

U.S. Patent #7,735,475

70021 Basic Kit shown, 70020 is same except it has a satin finish.

This kit will require an EFI fuel pump, regulator and filter.

Pt. No.	Description
70020	Powerjection III Basic Kit - Return - Satin
70021	Powerjection III Basic Kit - Return - Polished
70026	Powerjection III Complete Kit - Return - Satin
70027	Powerjection III Complete Kit - Return - Polished
70028	Powerjection III Complete Kit - Returnless - Satin
70029	Powerjection III Complete Kit - Returnless - Polished
70107	Powerjection III Fuel Delivery & Return Fuel Line Kit
70108	Powerjection III Fuel Delivery Fuel Line Kit

Now with Spark Control

The **Basic Kit** includes everything shown in the photo at left. Use the **Basic Kit** on vehicles that already have a return line, adequate fuel pump, and a fuel pressure regulator. The **Complete Kits** include everything shown in the photo above. The only option that may be required is the 70107 Powerjection III Fuel Delivery & Return Line Kit. This kit includes enough -06AN stainless hose and fittings to plumb both the fuel delivery line and a fuel return line. Hose ends and fittings are included for the fuel pump and filter. The 70108 Fuel Line Kit may be used with the Returnless Systems which do not require a return line.

All of the listed kits are suitable for any 4, 6 or 8 cylinder engine from stock up to 550 HP. Will not work on an air cooled engine. **Important Note:** If you want to utilize the spark control feature you must have a 2-wire distributor and a CDI spark box such as the Powerfire II Distributor (page 9) and the Powerfire VI CDI box (page 8).

The Powerjection III is the industry pioneer in self-learning, carburetor replacement EFI systems. The ease of installation and clean looks with minimal wiring make it perfect for converting hot rods, street machines or custom cars to fuel injection. The "Adaptive Learning" feature reduces the amount of interaction needed with the ECU (computer) while maintaining a complete level of tuning not always available with other systems in the market. All at a price point making fuel injection available to the mass market.

While this is one of the simplest and most affordable systems available, it doesn't mean that quality is left behind. The ECU was engineered and developed and is assembled at our facility in California. We utilize wideband oxygen sensor measurements for complete tuning capabilities. A 2.5 BAR MAP sensor is integrated into the EMS to measure up to 22 PSI boost for supercharged/turbocharged applications. The ECU mounts directly to the throttle body to eliminate nearly all of the wiring and prevents unnecessary holes in the firewall. Built-in timing (spark) control allows for complete engine management. To utilize the timing control feature in the Powerjection III you will need to use a 2-wire distributor and an external CDI box such as

the Professional Products Powerfire II Distributor (see page 9) and the Powerfire VI CDI unit (see page 8). With timing control you can program your own advance curve and total spark advance right from your laptop.

We pioneered the "Adaptive Learning" feature which handles much of the tuning chores for you in the background while you drive. When you choose a calibration, based on the particular parameters for your engine, the interface creates a base calibration for you. Then, take the car out in normal driving conditions with a few full throttle runs mixed in and the EMS will dial in the fuel and the system will adjust to temperature, altitude and other driving scenarios you might encounter. While the adaptive learning will handle most performance applications, the Powerjection III is fully programmable via laptop connection, providing for optimum tuning for higher performance or specialized applications.

This is one of the most technologically advanced EFI systems available in the aftermarket. The Powerjection III is available in return systems, or with the addition of our **FuelOnDemand** fuel pump control module, as a fully returnless system. See page 5 for details on the **FuelOnDemand** kit.

Now available from Professional Products is the new Powerjection+Plus for several popular applications. This is a port injection system that uses eight 42 lb/hr injectors that will handle engines up to 800 horsepower. One of the main competitive features of this new system is the EMS (computer) is now mounted directly on the manifold assembly. This eliminates the necessity for mounting the com-

puter under the dash and cutting a hole in the firewall for the harness. And this also eliminates the harness which provides for a much cleaner looking engine assembly.

The Powerjection+Plus EFI System is designed to utilize a return line but can also be configured as a returnless system by combining it with the FuelOnDemand (#70035) fuel pump controller.

Large volume fuel rails for maximum fuel flow with high quality adjustable regulator.

ECU (computer) mounted on the manifold assembly. Will clear HEI distributor

SB Chevy Kit Shown #70051

Clamp-on O₂ bung eliminates welding.

Wideband O₂ sensor provides accurate A/F ratio. (Not shown)

Check out these features:

- Self learning technology which was pioneered in the aftermarket performance industry by Professional Products and now copied by many companies.
- EMS (computer) mounted directly on the manifold assembly which vastly simplifies installation.
- System utilizes a wide band O₂ sensor which provides the most accurate calibration of the air/fuel ratio.
- New design EFI fuel pump delivers trouble free high performance fuel delivery.
- Clamp-on O₂ bung eliminates the need for welding on the exhaust system. But can be welded if desired.
- Eight 42 lb/hr injectors and 1200 CFM throttle body provide enough fuel and air to handle engines making up to 800 HP.
- Compact EMS contains a 2.5 BAR MAP Sensor which eliminates the need for remote mounting and plumbing this sensor, as found on most other systems.
- Includes Spark Control. To use the Spark Control you need a 2-wire distributor and an external spark box.

SEE WEBSITE FOR MORE DETAILS ON THESE KITS.

Pt. No.		Application
Satin	Polished	
70050	70051	SB Chevrolet V8 (265-400 CID)
70052	70053	BB Chevrolet V8 (396-502 CID)
70054	70055	SB Ford V8 (260-302 & 5.0L)
70056	70057	SB Ford V8 (351W)

70108

Fuel Line Kits for EFI Systems

Left - This kit provides 15 feet of -06AN stainless braided fuel line and -06AN hose ends and fittings to connect your fuel pump and filter to the EFI system for a returnless installation.

Right - This kit provides 25 feet of -06AN stainless braided fuel line and -06AN hose ends and fittings to connect your fuel pump and filter to the EFI system and back to the tank for a return style fuel system.

70107

3

70035

FuelOnDemand™ Kit

Here are the FuelOnDemand's various applications:

- **Use with a carburetor.** Use with a regulator to maintain correct 5-7 PSI while reducing pump duty cycle by as much as 70%. This is 70% less noise, heat and current draw. But when the engine needs more fuel, it's there.
- **EFI with return (bypass) regulator.** Allows the use of large high volume electric fuel pumps without the constant noise, and even more important, the heat produced by the pump is reduced. This equals longer life and reduced pump cavitation which is like engine detonation to your pump, the single largest cause of pump failure.
- **EFI Returnless.** Run a single inlet fuel line from the tank and let the FuelOnDemand Module control your fuel pressure.

The FuelOnDemand system is fully programmable. You can basically set it up to provide different fuel pressure at different load conditions. Here's an example. Let's say you are running a port injection system (such as Powerjection+Plus) and you are running 30 lb./hr. injectors at 45 PSI. This will supply enough fuel to support 425 HP. If you try to run more pressure (which raises the lb./hr. rating) the car won't run properly at idle or low engine speeds. But with FuelOnDemand you can program it to run at 45 PSI at low or no load conditions and have the fuel pressure increase to 70 PSI under load. Now your 30 lb./hr. injectors become 38 lb./hr. injectors and are capable of supplying enough fuel for 540 HP. The unit has a 2.5BAR (25PSI) MAP sensor which can handle blown engines up to 25 pounds of boost. Any vehicle running a high volume electric pump should use FuelOnDemand to lessen pump noise, decrease fuel temperatures (which can lead to vapor lock), and extend pump life by eliminating dead heading.

This is our FuelOnDemand Module. This kit is included in the 70028 and 70029 Complete Kits which allow them to function as a returnless system. Also, this kit can be used with any other aftermarket EFI system to convert it to a returnless type setup. All you need is a 1/8-NPT tapped hole into the pressurized fuel system where the Fuel Pressure Sensor can be installed. Note that from a performance standpoint a return style system is preferable but the returnless setup eliminates the need to install a return line.

Pt. No.	Description
70035	FuelOnDemand Kit w/fuel pressure sensor

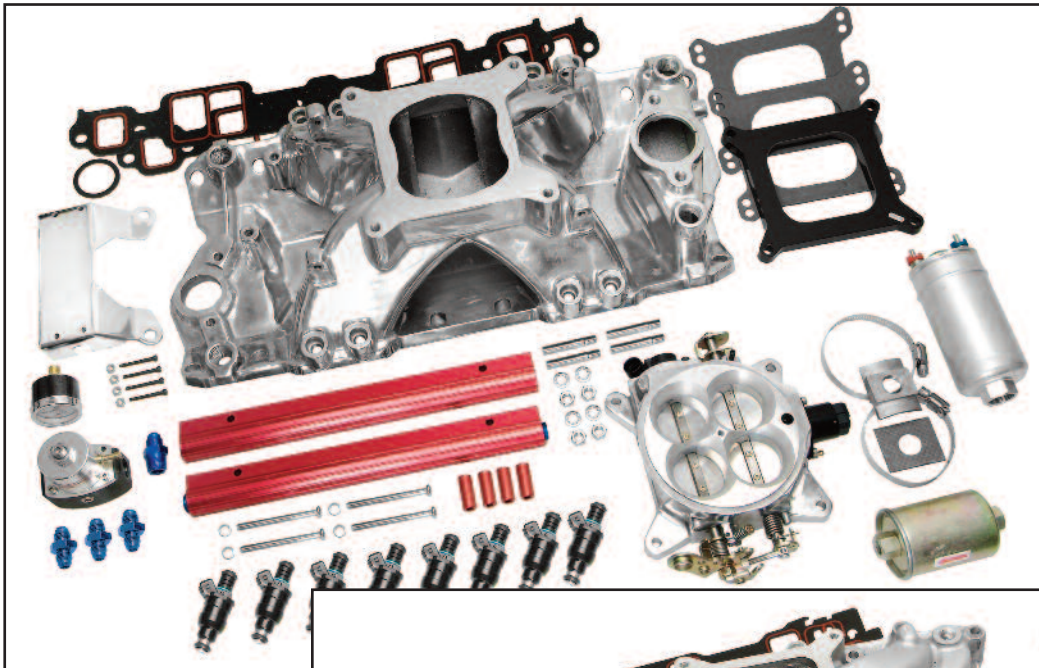

**SB Chevy
70050/70051**

The photo at left shows all the components that make up the Powerjection+Plus kit for the small block Chevy V8, except the various wiring harnesses are not shown. A polished kit includes a polished manifold and a polished throttle body.

**SB Ford
70054/70055
70056/70057**

The photo at right shows the SB Ford 351W Powerjection+Plus kit. The SB Ford 260-302 & 5.0L is the same except for the manifold and that kit also includes a carb spacer which is required to provide clearance between the throttle body linkage and the fuel rails.

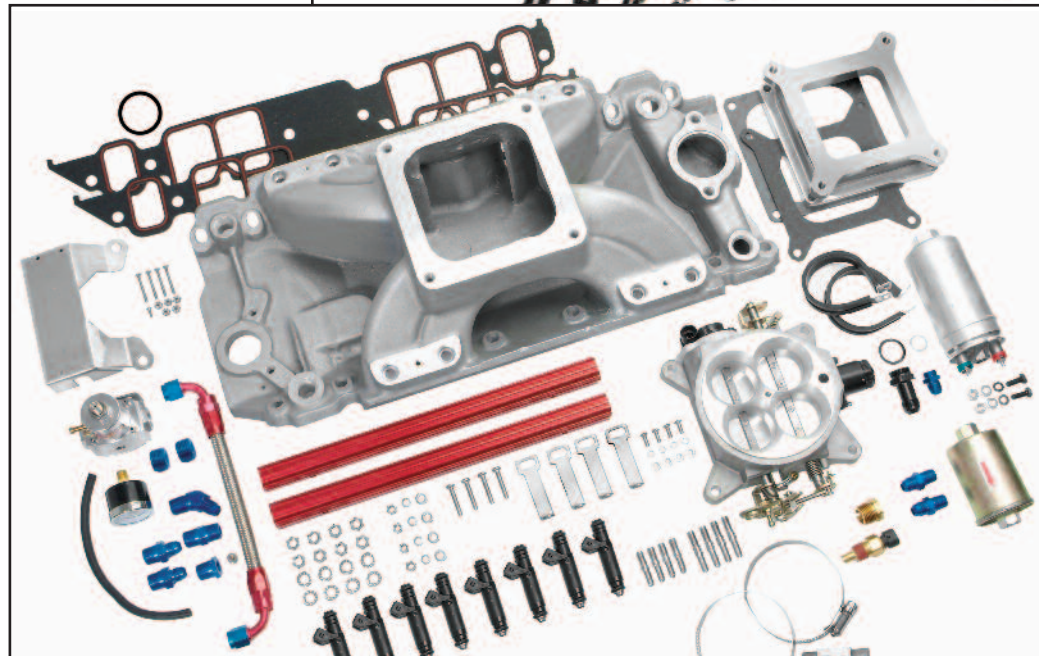
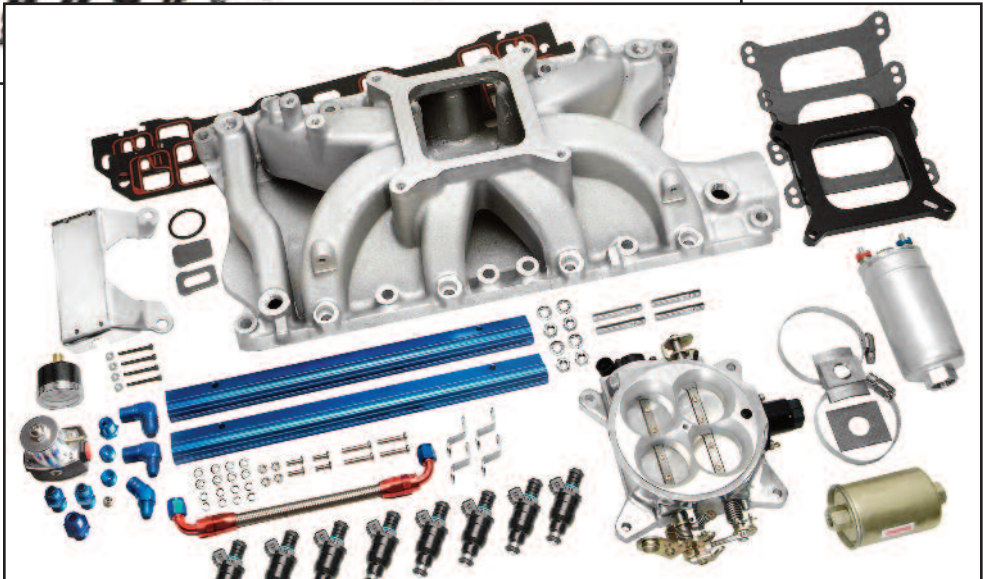

**BB Chevy
70052/70053**

The big block Chevy Powerjection+Plus kit fits rectangular port heads. Because the manifold was originally designed for a Dominator carburetor, a special 4150 to 4500 adapter is included as part of the kit to adapt the P/P throttle body to the intake manifold.

70042 Shown



3

Fuel Inlet Kits for use with Powerjection III EFI Throttle Bodies

The 70042 Fuel Inlet Kit, shown at left as part of the Powerjection III, is supplied with the 70026 or 70027 versions of the Powerjection III that require a regulator. If you currently have either of these EFI kits and want to add on our **FuelOnDemand** module, then a regulator is not required when running a returnless system. In that instance you will need to switch the inlet kit to either a 10409 or 10416 (shown below). If you want to run a return line in conjunction with the **FuelOnDemand** system (preferred setup) you will continue to use the 70042 Fuel Inlet Kit that came with your 70026 or 70027 Powerjection III EFI system.

Pt. No.	Description
70042	Fuel Inlet Kit with regulator (Black) -06 Inlet (Replaces 70041)
10409	Fuel Inlet Kit (Black) -08 or -06 Inlet*
10416	Fuel Inlet Kit (Red/Blue) -08 or -06 Inlet*

*See below and page 35 for more details on these kits.



This kit can be configured to have either a -06AN or -08AN inlet nipple.

10409

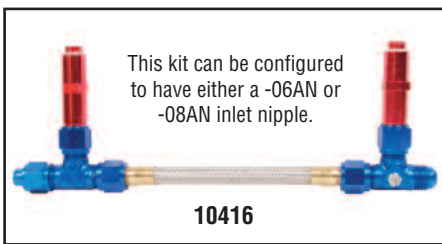

This kit can be configured to have either a -06AN or -08AN inlet nipple.

10416

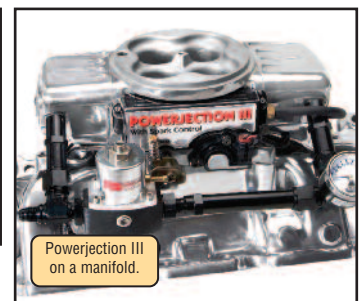

Powerjection III on a manifold.

The 10409 Inlet Kit (Black) shown above is supplied as part of the 70020, 70021, 70028 and 70029 Powerjection III kits. Or it can be used by those designing their own fuel system using a Powerjection III, (or who have a FuelOnDemand module) or it can be used on Demon carbureted applications. Additional styles of this Fuel Inlet Kit to fit Holley 4150 and 4500 carburetors can be found on page 35 of this catalog.

The 10416 Inlet Kit (Red/Blue) shown above, is a base fuel inlet for those designing their own fuel system using either a Powerjection III or a Demon carburetor. Additional kits of this type to fit other style carburetors (Holley 4150, 4500) can be found on page 35 of this catalog. The Professional Products Fuel Inlet Kits feature a wrench hex half way down the inlet extension which makes installation very easy.

Fuel Injection Throttle Bodies



70202

3

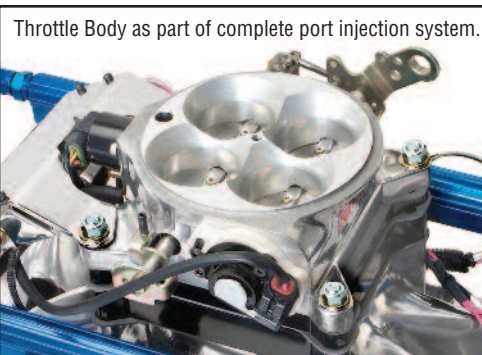

Throttle Body as part of complete port injection system.

EFI Throttle Bodies

The cast throttle bodies have a linkage like a 4150 Holley so that the various cable and linkage combinations will connect properly. They also feature a special adapter that allows the use of either a Ford or a GM throttle position sensor. Our cast throttle body is a very high quality product and is substantially less expensive than other competitive 4-bbl style throttle bodies. If you are assembling your own EFI system using one of the many available computer systems, we can provide you with the necessary throttle body, fuel injection style intake manifold or fuel rail kits (see page 31). Please note that CFM ratings on EFI throttle bodies are not to be compared to carburetor CFM ratings. You can successful use these throttle bodies on an engines from 350 to 500 CID.

Pt. No.	Description
70201	Cast CFM 4-bbl Throttle Body. - Satin
70202	Cast CFM 4-bbl Throttle Body - Polished

Sensors and Accessories

Pt. No.	Description
70020-04	Data Pack (Includes comm cable)
71200	Throttle Position Sensor TPS
71210	Idle Air Control (IAC)
71230	Coolant Temperature Sensor
71235	Fuel Pressure Sensor
71240	Oxygen (O ₂) Sensor
71250	O ₂ Sensor Bung Assembly



71200

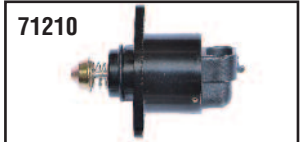

71210



71230



71235



71240



Can be clamped on or welded.

71250

Powerfire™ Ignition Products

POWERFIRE VI™ Capacitive Discharge Ignition 3

The Powerfire VI Capacitive Discharge Ignition combines all the power and efficiency of a digital CDI system with the enhanced features of a **built-in rev limiter and dual step rev control**, all included at very competitive pricing. All electronic components were designed and engineered, and are manufactured at our facility in Hawthorne, CA. This unit represents the latest in CDI engineering and development.

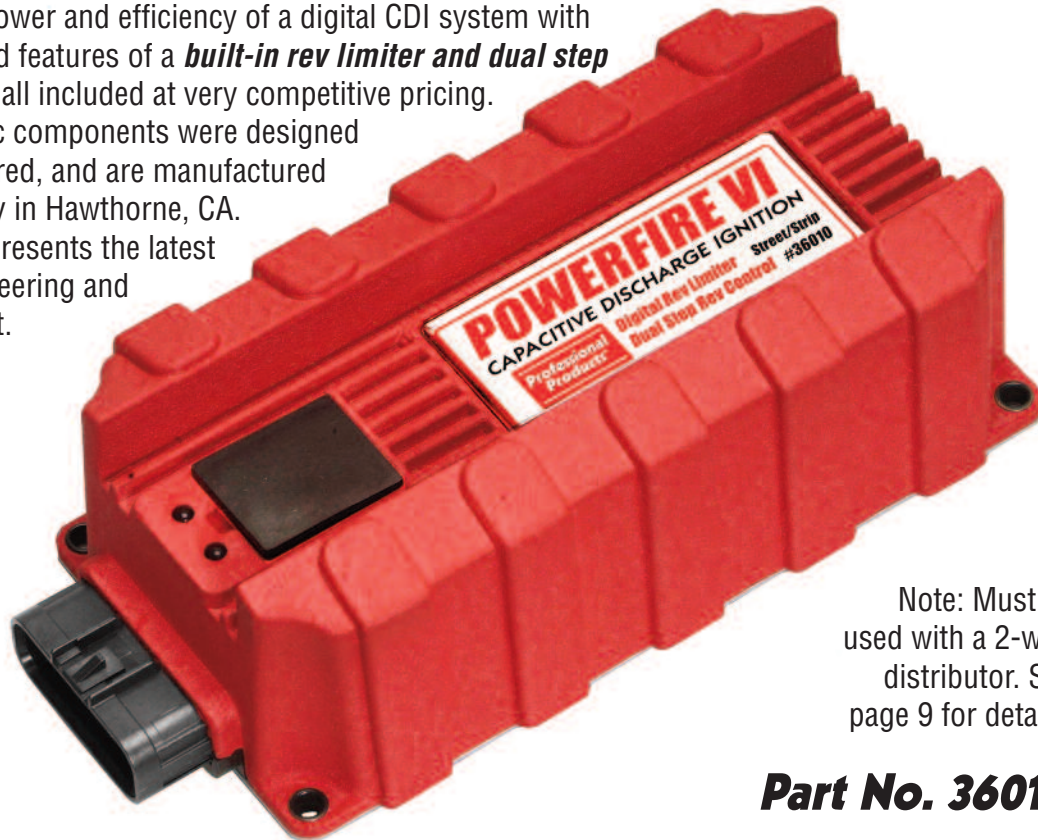

Note: Must be used with a 2-wire distributor. See page 9 for details.

Part No. 36010

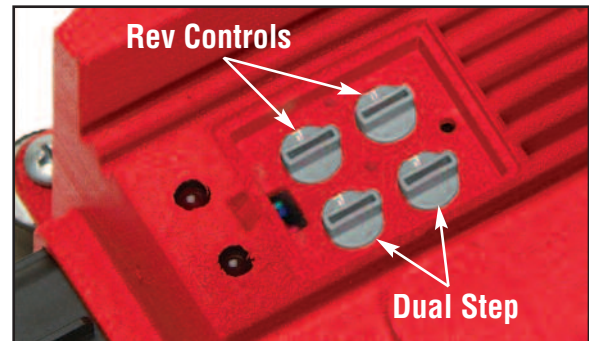

POWERFIRE VI DIGITAL CDI FEATURES

- High output multi-spark ignition system provides quicker acceleration and throttle response and better driveability.
- Advanced digital technology provides 1/4-degree timing accuracy up to 10,000 rpm.
- Digital circuitry creates more performance with lower power draw compared to analog systems found in some competitive units.
- Produces powerful spark up to 15,000 rpm.
- Outputs over 530 volts and up to 135 mJ of energy.
- Provides 20° of spark duration.
- Adjustable Digital Rev Limiter **built-in**.
- Digital Dual Step Rev Control is **built-in and included** (many competitive systems require an add-on module at extra cost). The Powerfire VI is very affordable.
- Four easily accessible rotary dials allow for quick set up of rev limiter and rev control.
- A very easy installation. Can be performed in 30 minutes.
- Plug and play with all brands of 2-wire distributors.
- 4, 6, and 8 cylinder compatible.
- Operates on most 12-18 volt negative ground electrical systems.
- Electronic components designed, engineered and manufactured in the USA.
- Heavy duty die cast aluminum sealed housing.
- As with all CDI ignitions, the Powerfire VI will only work with a conventional 2-wire distributor such as the Powerfire II Distributor found on page 9 of this catalog. This is an inexpensive yet high quality distributor.

POWERFIRE™ Ignition Systems & Components

POWERFIRE I

Adjustable • Ready-to-Run • 3-Wire

The Powerfire I represents the latest state-of-the-art design in modern ignitions systems. It won the Best Engineered New Product at the 2008/2009 SEMA Show. It's most outstanding feature is it has an external knob that allows timing adjustment while the engine is running. Each click of the knob advances or retards the timing 1/2 degree. Set your timing approximately with a timing light. Then dial it in exactly with the timing knob. Get a bad load of gas? Dial in some retard and you're good to go. Going racing and need some more timing? Just dial it in.

Check out these features:

- Easy 3-wire install with no external spark box necessary.
- Precision CNC machining and hand assembled construction.
- Patent pending positive lock manual advance/retard knob. Distributor can be accurately advanced or retarded in 1/2-degree increments on the fly by turning the external adjustment knob. Each click of the knob provides a 1/2-degree change to total ignition timing. This makes getting an accurate setting extremely easy.
- Accurate super hot spark all the way through 10,000 RPM.
- Hardened steel .50" diameter steel shaft with sealed roller bearing upper support and bronze bushed lower support for extreme stability at maximum rpm.
- Powerful magnetic pickup and CNC machined reluctor pickup.
- Fully adjustable advance mechanism with easy to use spring and bushing design for a nearly infinite advance curve.
- POWERFIRE module built in for drop-in reliability from 50 to 10,000 RPM.
- Hot cranking spark as low as 50 RPM for quick starting.
- Black anodized base with laser etched timing marks for easy visibility and high tech looks.
- High quality injection molded cap with brass terminals for long life and great conductivity.
- **This distributor can be used with the Powerjection systems but the spark control feature of the Powerjection cannot be enabled. To utilize the Powerjection spark control feature you must use the Powerfire II Distributor below and the Powerfire VI CDI (or other aftermarket 2-wire distributor and CDI spark box)**

POWERFIRE II

2-Wire Distributor (for use with CDI)

The Powerfire II is a precision made distributor for two wire ignition systems. Includes vacuum advance canister for economy plus a mechanical advance system to dial in the perfect advance curve for your engine. An oversize steel shaft is coupled with an upper sealed ball bearing, brass cap terminals, adjustable mechanical advance and a high output magnetic trigger. This distributor is good for 10,000 rpm. Compare the Powerfire II to an MSD 8361 Standard Pro-Billet Distributor. This distributor requires the use of an aftermarket CDI box such as the Powerfire VI (See pg. 8).

Pt. No.	Description
30000	Powerfire I for 262-454 Chevrolet V8
30001	Powerfire I for 289-302 Small Block Ford
30002	Powerfire I for 351W Small Block Ford
30040	Powerfire II for 262-454 Chevrolet V8
30041	Powerfire II for 289-302 Small Block Ford
30042	Powerfire II for 351W Small Block Ford
30100	Powerfire 2 Coil (Black Housing)
30200	Powerfire 2 Coil (Red Housing)
31000	Replacement Cap for all Powerfire Distributors
31002	Replacement Rotor for all Powerfire Distributors
31003	Advance Spring & Weight Kit
31004	Bronze Gear for Chevrolet
31005	Bronze Gear for SB Ford (except 351W)
31006	Advance Lockout Kit for SB Ford
31007	Advance Lockout Kit for Chevy

POWERFIRE I

2

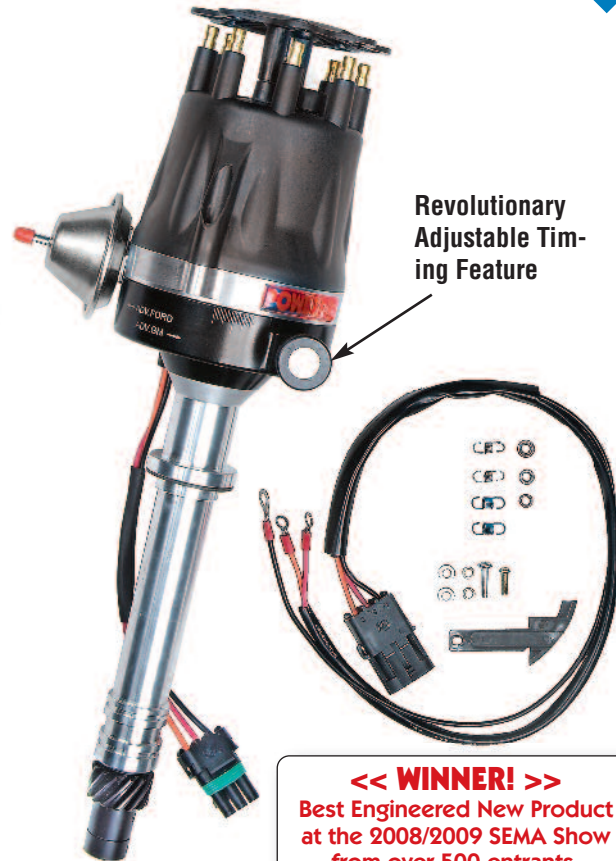

Revolutionary Adjustable Timing Feature

<< WINNER! >>
Best Engineered New Product at the 2008/2009 SEMA Show from over 500 entrants.

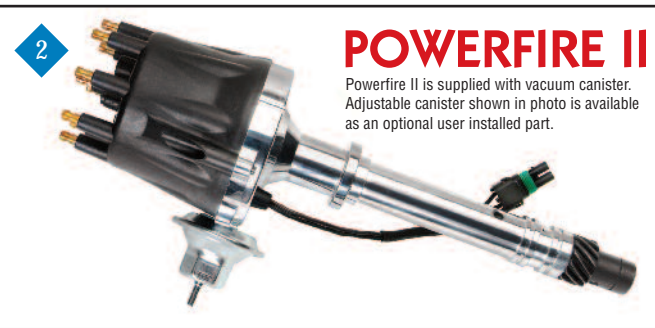

POWERFIRE II

Powerfire II is supplied with vacuum canister. Adjustable canister shown in photo is available as an optional user installed part.

Pt. No.	Description
31008	Gasket for Chevy Distributor
31009	O-Ring for SB Ford
31010	Vacuum Advance Canister
31011	Ignition Module*
31012	Ignition Pickup Assy. (Chevy)*
31013	Distributor to Coil Harness*
31014	Bronze Gear for Ford 351W
31015	Ignition Pickup Assy. (Ford)*
31016	Iron Gear for Ford 351W
31017	Steel Gear for Chevy
31018	Steel Gear for Ford (exc. 351W)
31019	Steel Gear for Ford 351W
31021	Vacuum Advance Can. (Adj)

The replacement parts listed above in blue in most instances fit both Powerfire I and II unless noted otherwise.
*For Powerfire I only.

POWERFIRE COILS™ 3

Professional Products now offers a line of extreme high performance coils. The relatively new multi-coil arrangements offer a big advantage over the old single coil designs. Multiple coil sets on V8 engines only fire 1/8th as many times as a single coil. This extra time between firings allows the coil more time to regenerate itself

producing a hotter spark. The advantage that the Professional Products Coils have over competitive models as well as stock coils is the actual duration of the spark produced is longer with the Powerfire Coils. Longer spark duration, even though measured in microseconds, produces more complete combustion and more power.

LSX Powerfire Coils NEW



30500 8-Coil Set
30600 Single Coil
 For 1998-'04 cars w/VIN G/S, and 1998-'06 trucks with VIN E & D. LS1/LS6 (Application same as MSD 82858 and 8285) (8th digit in the VIN is the engine code)



30501 8-Coil Set
30601 Single Coil
 For 1999-'07 G.M. 4.8L, 5.3L, 6.0L, 2003-'07 Hummer 6.0L with VIN Z, N, T, V, U, B, & P. (Application same as MSD 82868 and 8286)



30502 8-Coil Set
30602 Single Coil
 For 2005-'13 Cars w/5.3L, 6.0L, 7.0L, 8.1L w/VIN M & C. 2005-'13 Trucks w/5.3L, 6.0L w/VIN G, T, U & H. (Application same as MSD 82878 and 8287)



30503 8-Coil Set
30603 Single Coil
 For 1999-'09 G.M. 4.8L, 5.3L, 6.0L, 8.1L, 2003-'07 Hummer 6.0L with VIN Z, N, T, V, U, & B (Application same as MSD 82648 and 8264)

Ford Powerfire Coils NEW



30650

The Ford line of Powerfire Coils are among the most powerful coils available for the popular late model Mustangs as well as other Ford models with the same model year and engine combination. You can pay more for a Ford coil but you can't buy better.

Pt. No.	Application
30550	8-Coil Set - 1996-'14 - 4.6L/5.4L 2V
30650	Single Coil - 1996-'14 - 4.6L/5.4L 2V
30551	8-Coil Set - 1999-'14 - 4.6L/5.4L 4V
30651	Single Coil - 1999-'14 - 4.6L/5.4L 4V
30552	8-Coil Set - 2004-'08 - 4.6L/5.4L 3V
30652	Single Coil - 2004-'08 - 4.6L/5.4L 3V

Hemi Powerfire Coils NEW



30660

The Hemi engine used in the late model Chrysler and Dodge vehicles has once again brought Mopars into the forefront of the performance world. And a set of Powerfire Coils from Professional Products assures that your Hemi coil performance will be the very best available at any price. These coils exceed the stock coil in every parameter that you can measure. Total voltage output, spark energy, and most importantly spark duration. A longer spark duration assures a more complete combustion of the fuel/air charge in your cylinders which results in more power.

Pt. No.	Application
30560	8-Coil Set '03-'05 5.7L Hemi
30660	Single Coil '03-'05 5.7L Hemi
30561	8-Coil Set '05-'14 5.7/6.1L Hemi
30661	Single Coil '05-'14 5.7/6.1L Hemi



30661

LSX Coil Wire Sets NEW

Powerfire Coil Wire Sets for all LS engines are available in either 8.5 mm silicone (black wire and red boots) or 8 mm rubber (red wire and black boots). Quality Wire Sets from Professional products.



- 33000 LSX Silicone Coil Wire Set
- 33010 LSX Rubber Coil Wire Set

Powerfire 2 Canister Coils



Powerfire 2 canister style coils no longer use ancient oil filled technology, but instead are epoxy potted eliminating any leaks while providing a smaller overall canister that still packs a wallop. With 45,000 volt output, peak current of 140 milliamps, and spark duration of 350 microseconds, these coils are state-of-the-art products.

Pt. No.	Application
30100	Canister Coil w/black case
30200	Canister Coil w/red case

Power+Plus™ Intake Manifolds

Black Typhoon Manifold for LS1/LS6

NEW

RPM RANGE
1500 to
6500

3

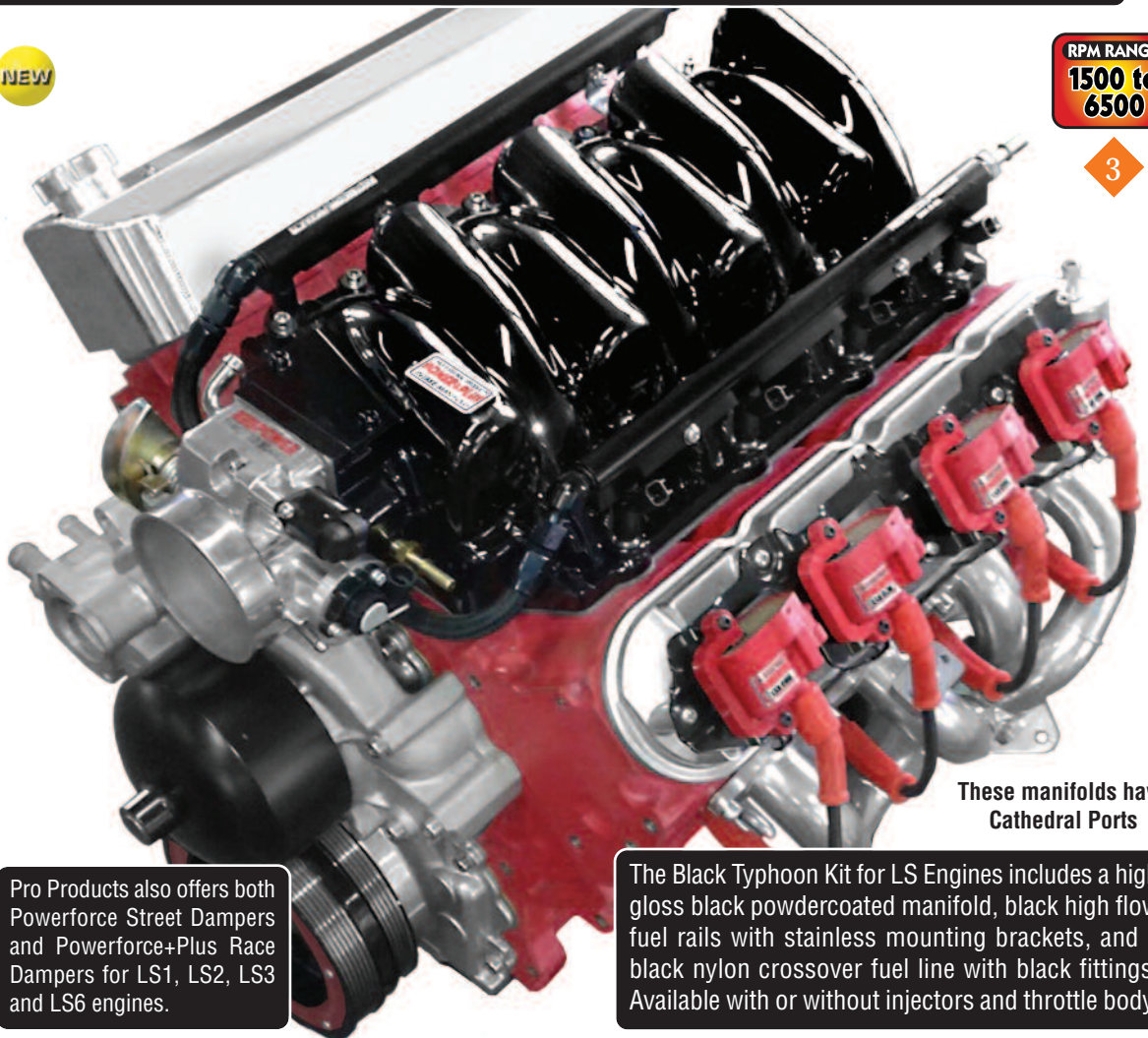

These manifolds have
Cathedral Ports

Pro Products also offers both Powerforce Street Dampers and Powerforce+Plus Race Dampers for LS1, LS2, LS3 and LS6 engines.

The Black Typhoon Kit for LS Engines includes a high gloss black powdercoated manifold, black high flow fuel rails with stainless mounting brackets, and a black nylon crossover fuel line with black fittings. Available with or without injectors and throttle body.

TYPHOON™

New for 2016! Pro Products now offers four new Black Typhoon Intake Manifold Systems for LS1 and LS6 engines. The kits are offered with either an 85MM inlet or a 96MM inlet. Kits are also available packaged with matching Pro Products Power Throttle Bodies (manual linkage only) for the complete intake system. The Black Typhoon Manifold System is also available with or without injectors.

Also consider the new Pro Products high voltage LS Coil Packs along with matching Powerfire+Plus Coil Wire sets with red boots and black silicone wires or the inexpensive Powerfire Wire Sets with black boots and red rubber wires. See page 10 of this catalog for the Coils and Coil Wires. Finish off your LS engine with one of our popular Powerforce Street or Powerforce+Plus Race Harmonic Dampers that can be found in the Harmonic Damper section of this catalog.

Pt. No.	Description
52070	Black Typhoon for LS1/LS6 - 85MM Inlet - w/o T.B or injectors
52071	Black Typhoon w/85MM Throttle Body - w/o injectors
52072	Same as 52070 with (8) injectors - w/o throttle body
52073	Same as 52071 with (8) injectors - with throttle body
52074	Black Typhoon for LS1/LS6 - 96MM Inlet - w/o T.B. or injectors
52075	Black Typhoon w/96MM Throttle Body - w/o injectors
52076	Same as 52074 with (8) injectors - w/o throttle body
52077	Same as 52075 with (8) injectors - with throttle body

Kits with supplied throttle bodies include a polished throttle body
Kits with supplied injectors include (8) 26-lb injectors

The new Black Typhoon Manifolds have a high gloss black powdercoat finish that will give your engine a look like no other. Coupled with the manifold are black anodized high flow fuel rails that complement the entire contemporary look of your engine. The Powerfire Coils and Coil wires provide the finishing touch.

3 GM LS1/LS6 Typhoon Intake Manifolds

52070

Without Throttle Body
and Injectors

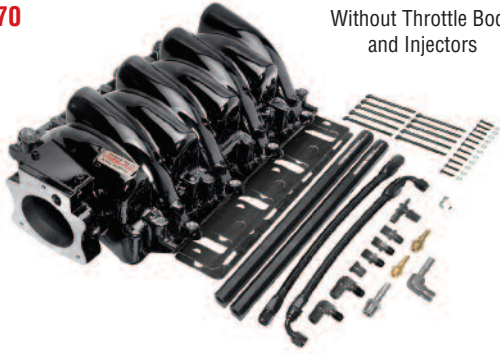

#52070 - Black Typhoon Manifold for LS1/LS6 with 85MM Inlet. Does not include Injectors or Throttle Body.

52074

Without Throttle Body
and Injectors

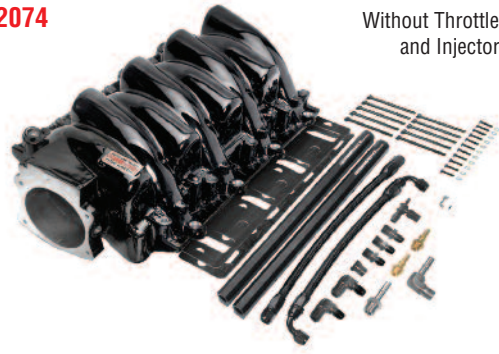

#52074 - Black Typhoon Manifold for LS1/LS6 with 96MM Inlet. Does not include Injectors or Throttle Body.

52071

Without Injectors and
with Throttle Body



#52070 - Black Typhoon Manifold for LS1/LS6 with 85MM Inlet. Does not include Injectors. Includes Throttle Body

52075

Without Injectors and
with Throttle Body



#52075 - Black Typhoon Manifold for LS1/LS6 with 96MM Inlet. Does not include Injectors. Includes Throttle Body.

52072

Without Throttle Body
and with Injectors



#52070 - Black Typhoon Manifold for LS1/LS6 with 85MM Inlet. Does not include Throttle Body. Includes Injectors.

52076

Without Throttle Body
and with Injectors

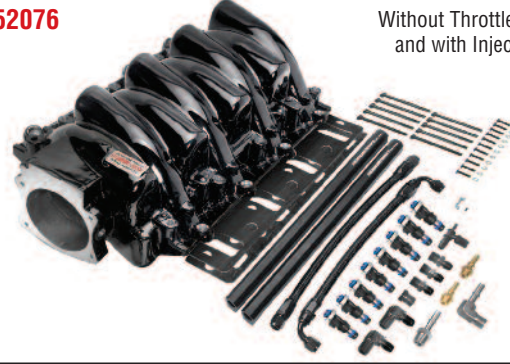

#52074 - Black Typhoon Manifold for LS1/LS6 with 96MM Inlet. Does not include Throttle Body. Includes Injectors.

52073

With Throttle Body
and with Injectors



#52070 - Black Typhoon Manifold for LS1/LS6 with 85MM Inlet. Includes Injectors and Throttle Body.

52077

With Throttle Body
and with Injectors



#52074 - Black Typhoon Manifold for LS1/LS6 with 96MM Inlet. Includes Injectors and Throttle Body.

Selecting the right manifold for your small block Chevy

We make a number of manifolds for small block Chevys and for some people, it may be confusing trying to figure out which one is the best for a specific application. The following information

should be helpful in allowing you to make an informed decision. All of these manifolds will fit up through model years 1995 (except Vortec which is 1996 & later) due to our unique supplied adapters.

CYCLONE

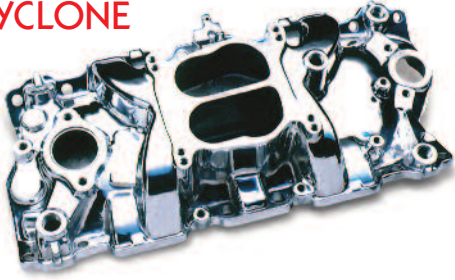

CYCLONE - The Cyclone is our lowest profile SB Chevy manifold and is also the only one that is street legal on pollution controlled vehicles. It is set up to accept a spread bore carb but comes with an adapter plate that permits the use of square bore carbs. To remain street legal with a square bore carb, you must use one that is also approved as street legal for your application. This is our largest selling manifold with tens of thousands of them in use. This manifold is available in six different design

configurations:

52000 - Polished for std heads
52001 - Satin for standard heads
52006 - Polished for Vortec heads
52007 - Standard for Vortec heads
52008 - Polished w/EGR provision
52009 - Satin w/EGR provision
These are great all around street manifold for medium performance applications at affordable prices.

CYCLONE+PLUS

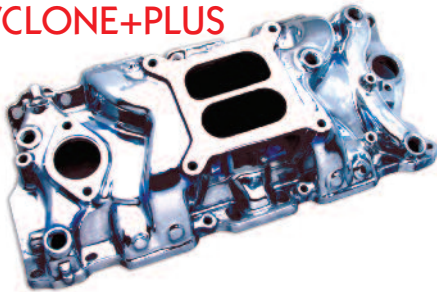

CYCLONE+PLUS - The terrific Cyclone+Plus is a step up from the Cyclone. Due to its slightly taller height, it can provide more power and torque. It is about 3/8" taller than the Cyclone. It also has a rear water crossover (the only SB Chevy manifold made by anyone with this feature), nitrous bosses and a square bore carburetor flange. The Cyclone+Plus is available in two different versions and is one of our most popular manifolds for SB Chevy. We feel this is one of our best all around manifolds

for a high performance street applications.

52012 - Polished
52013 - Satin

A great medium performance manifold that includes all the latest manifold technology for the street.

TYPHOON

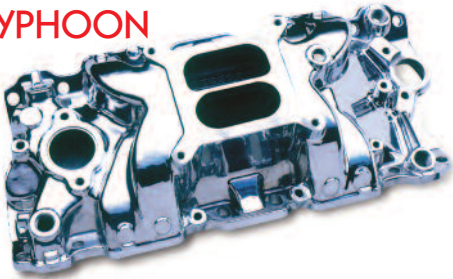

TYPHOON - The Typhoon manifolds, along with the similar CrossWind, are the most powerful dual plane manifolds available for a small block Chevy. For non-pollution controlled street machines, these are among the very best manifolds you can use. They feature a square bore carburetor flange, nitrous bosses, four corner water ports, and dual distributor holddowns. These manifolds are approximately 5/8" taller than the Cyclone series. On medium horsepower engines, our dyno tests have

shown that this manifold comes very close to producing similar power and torque numbers as our Hurricane racing intake manifold.

There are two part numbers in this series:

52020 - Polished finish
52021 - Satin finish

CROSSWIND



CROSSWIND - The CrossWind design features the identical plenum and runner design as the Typhoon. The main difference is that there is an open area under the plenum chamber. This feature is sometimes called an air gap design. The air flowing under the plenum provides a cooler charge for the incoming air with less heat transfer from the engine. This cooler air charge provides additional power. The CrossWind design is very popular. However, if looks is your main interest, along with more power,

the Typhoon might be a better choice because it is impractical to polish the open area below the plenum on the CrossWind.

52025 - Polished finish
52026 - Satin finish

HURRICANE Series

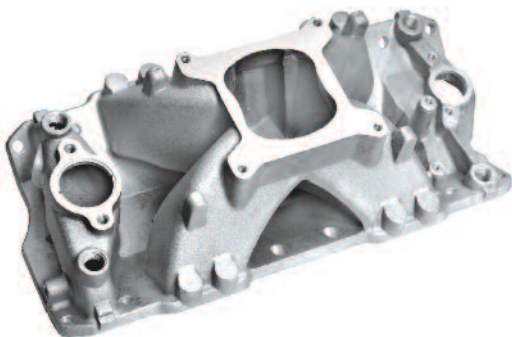

HURRICANE, HURRICANE+PLUS & SUPER HURRICANE

We now offer three models of this outstanding racing manifold. The Hurricane is one of our very most popular race manifolds. If you are looking for the utmost performance for the very least cost, this is your manifold. Professional Products now offers the Hurricane+Plus which is an improved version of the Hurricane. Depending upon exact engine configuration, this manifold has shown as much as 20 hp over the Hurricane. Note that these increases mainly occur above 7,500 rpm. For all out racing with large cubic inch engines (420+) on gas, or any size alcohol engine, the Super Hurricane is the manifold to select. Dyno

tests have shown significant power increases over competitive manifolds. The Super Hurricane is also available in a version with machined injector bosses.

52030 - Polished Hurricane
52031 - Satin Hurricane
52032 - Polished Vortec Hurricane+Plus
52033 - Satin Vortec Hurricane+Plus
52034 - Polished Hurricane+Plus
52035 - Satin Hurricane+Plus
52036 - Polished Super Hurricane
52037 - Satin Super Hurricane
52038 - Polished Super Hurricane*
52039 - Satin Super Hurricane*

*Includes machined injector bosses

In comparison dyno tests, the Hurricane series of manifolds consistently outperform the competition.

Small Block Chevrolet V8 Intake Manifolds

CYCLONE™

CYCLONE+PLUS™

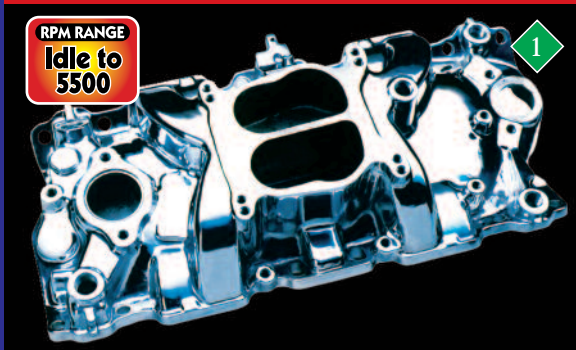

CYCLONE™ for 1957-'95 Small Block Chevrolet V8*

This is a great all around street manifold. It is a direct replacement for the stock intake manifold on non-EGR engines. The manifold includes special adapter bushings to allow fitment to 1987-'95 cylinder heads. Also includes an adapter plate to permit use of certain square bore carburetors. Professional Products intake manifolds are cast from steel molds, not sand. These permanent steel molds provide a tighter grain casting thereby reducing porosity as well as eliminating core shifting. Each manifold is 100% pressure tested to assure no leaks.

Pt. No.	Application
52000	1957-'95 SB Chevy V8 - Polished Finish (Non EGR)
52001	1957-'95 SB Chevy V8 - Satin Finish (Non EGR)

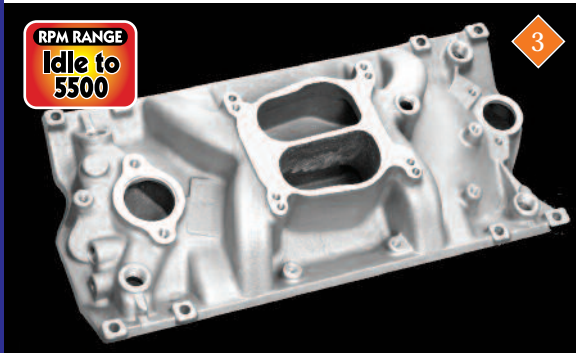

CYCLONE™ for SB Chevrolet V8 w/Vortec heads

This manifold is essentially identical to the above Cyclone model except it is designed to fit the 1996 and later Vortec style cast iron head (Gen1+) which features eight vertical attachment bolts instead of twelve angled attachment bolts. Will also work on 1996 and later Vortec engines or engines equipped with Edelbrock E-Tec aluminum heads. As with most Professional Products manifolds, this one features four corner water ports and is also supplied with an adapter plate to permit the use of most square bore carburetors such as the popular Holley, Demon and Edelbrock.

Pt. No.	Application
52006	SB Chevy V8 w/1996 & later Vortec heads - Polished
52007	SB Chevy V8 w/1996 & later Vortec heads - Satin

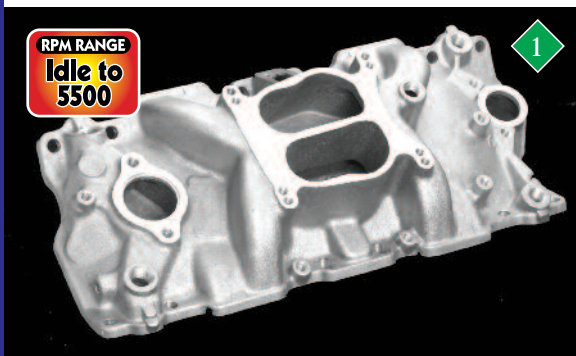

CYCLONE™ for 1957-'95 SB Chevrolet V8 (EGR)*

This manifold is a direct replacement for the stock 4-bbl manifold on 1972-'86 GM small block Chevy V8s with EGR and 1981-'86 GM Corporate 350 V8 engines with EGR. It is essentially the same design as the above two manifolds but incorporates EGR. Some applications may require our EGR adapter (52115) to provide clearance. This manifold is a great all around street manifold that is street legal on the listed applications. It will accept late model choke, waterneck, air conditioning, alternator, and HEI ignition systems. The manifold features dual distributor holddowns and four corner water ports. It is also supplied with an adapter plate and gasket to accept most square bore carbs.

Pt. No.	Application
52008	1957-'95 SB Chevy V8 - Polished Finish (EGR)
52009	1957-'95 SB Chevy V8 - Satin Finish (EGR)

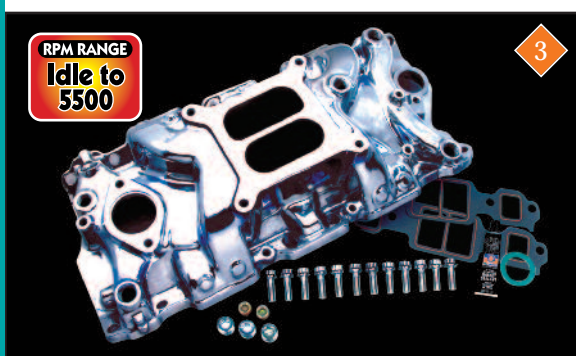

CYCLONE+PLUS™ for 1957-'95 SB Chevrolet V8*

The CYCLONE+PLUS is a unique new design unmatched by any other manifold manufacturer. It is approximately 3/8" taller than the Cyclone and it comes with a square bore carburetor flange which accepts most of the popular aftermarket carburetors. It's most distinctive feature is a rear water crossover passage. This is the only SB Chevy manifold with this feature. A feature which contributes significantly to a cooler running engine. The manifold also has nitrous bosses and four corner water ports. It also comes with stainless 12-pt bolts, intake gaskets, Permatex gasket sealer, pipe plugs, and insert bushings.

Pt. No.	Application
52011	1957-'95 SB Chevy V8 - Satin Finish



CYCLONE+PLUS™ for 1957-'95 SB Chevrolet V8*

This manifold is the same as the above Cyclone+Plus but comes without the stainless bolts, gaskets, and other supplied parts. It has all the same features outlined for the Cyclone+Plus shown above which includes the rear water crossover passage (an industry exclusive), four corner water ports, and nitrous bosses. This is an outstanding all around street manifold and is available in a polished finish, or a satin finish,

Pt. No.	Application
52012	1957-'95 SB Chevy V8 - Polished Finish
52013	1957-'95 SB Chevy V8 - Satin Finish

Small Block Chevrolet V8 Intake Manifolds

TYPHOON™ for 1957-'95 Small Block Chevrolet V8*

The Typhoon is one of our most popular high performance street manifolds. For most street applications we recommend a 600 to 700 CFM vacuum secondary carburetor. For high performance street use and bracket racing use a 700-800 CFM double pumper carburetor. This manifold produces outstanding power and is .70" taller than our low profile 52000/52001 Cyclone. It has a provision to machine for a front oil fill tube. No provision for exhaust heated or stock style chokes. This manifold will not fit under a stock Corvette hood.

Pt. No.	Application
52020	1957-'95 SB Chevy V8 - Polished Finish (Non EGR)
52021	1957-'95 SB Chevy V8 - Satin Finish (Non EGR)

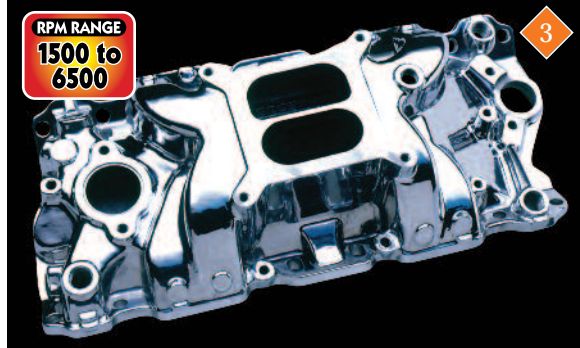

TYPHOON™

CROSSWIND® for 1957-'95 SB Chevrolet V8*

This manifold is essentially identical to the above Typhoon model except it is designed with an open area under the plenum (commonly referred to as an air gap design) which helps cool the incoming fuel/air charge and produces additional horsepower. It has all the same features as the above Typhoon. This is a truly outstanding high performance street manifold and one of our best sellers.

Pt. No.	Application
52025	1957-'95 Small Block Chevy V8 - Polished
52026	1957-'95 Small Block Chevy V8 - Satin

***Special Note: None of the marked manifolds for SB Chevys will work on engines with reverse flow heads as utilized on 1992-'96 LT1 Corvette or on 1993-'97 LT1 Camaro, Firebird, Caprice, Impala or Roadmaster.**

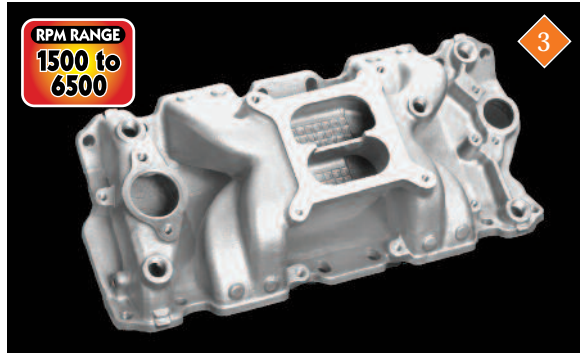

CROSSWIND®

CROSSWIND® for SB Chevrolet V8 w/Vortec heads

This is one of our very top selling manifolds and is very popular on a number of crate engines. It has been selected for use by leading crate engine builders because comparison dyno tests showed that it outperformed every other competitive manifold by a significant margin and was also less costly. It features a similar design to our Typhoon and conventional Crosswind. It offers nitrous bosses, four corner water ports, and dual distributor holddowns. We recommend using our Power+Plus intake gaskets #52605 which feature silicone sealing beads and are also significantly less expensive than competitive gaskets. If your engine has Vortec heads you can't buy a better street manifold for it than this one.

Pt. No.	Application
52027	1957-'95 SB Chevy V8 - Polished Finish
52028	1957-'95 SB Chevy V8 - Satin Finish

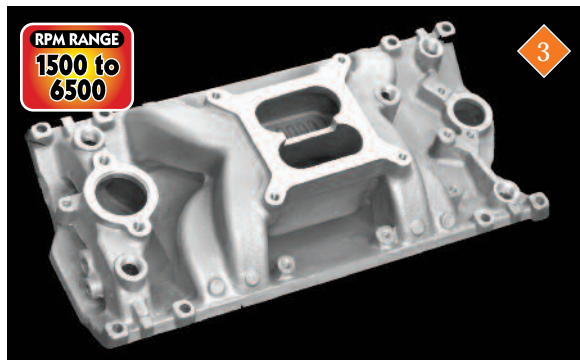

HURRICANE™

HURRICANE™ for 1957-'95 SB Chevrolet V8*

This manifold has long been the leader of the pack for single plane manifolds for small block Chevys with 23° cylinder heads. This manifold has consistently outperformed all of the well known brands which are also much more expensive. Numerous dyno tests have proven over and over that there is no better manifold of this type for achieving maximum power and torque while actually using less fuel doing it. Proving again the overall efficiency of the Hurricane. We have now developed the Hurricane+Plus which does the impossible by outperforming the Hurricane. However we will continue to offer the Hurricane as it is less expensive and provides more than enough power for most applications.

Pt. No.	Application
52030	1957-'95 SB Chevy V8 - Polished Finish
52031	1957-'95 SB Chevy V8 - Satin Finish

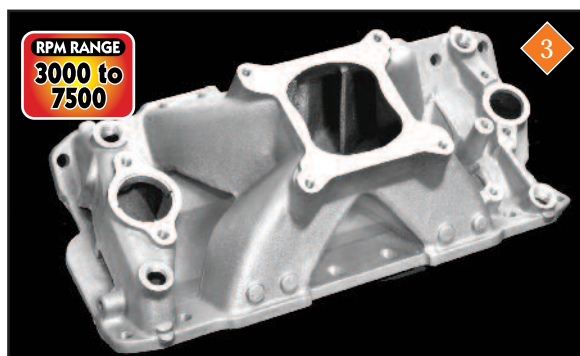

SUPER HURRICANE™ for 1957-'95 SB Chevrolet V8*

The Super Hurricane features a larger plenum and bigger runners than the other Hurricane manifolds. It was designed specifically for the new range of large cubic inch small blocks and works best on engines over 400 cubic inches. On the 427 and 454 small blocks now available there is no other manifold that will produce the power and torque of the Super Hurricane. It is also available machined for injectors. Use our 10608 Complete Fuel Rail Kit with this manifold when set up for fuel injection. This manifold can be ported out to a Fel-Pro 1209 gasket.

Pt. No.	Application
52036	1957-'95 SB Chevy V8 - Polished Finish
52037	1957-'95 SB Chevy V8 - Satin Finish
52038	1957-'95 SB Chevy V8 - EFI Version - Polished Finish
52039	1957-'95 SB Chevy V8 - EFI Version - Satin Finish

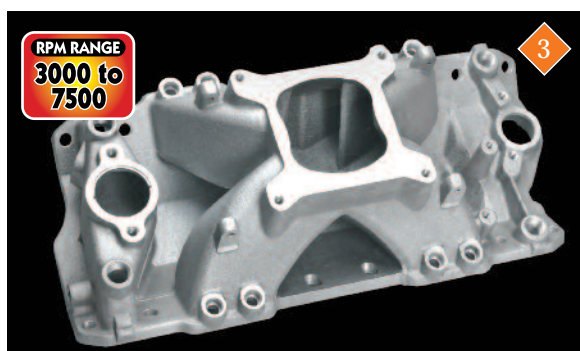

Small Block Chevrolet V8 Intake Manifolds

HURRICANE™

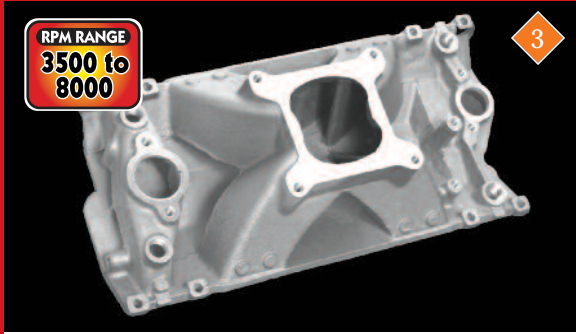

HURRICANE+PLUS™ for SB Chevrolet V8 w/Vortec

This manifold is the best performing single plane race style manifold available for engines using the 1996 and later Vortec (Gen 1+) cylinder heads. It has been proven over and over in dyno tests and on track use to provide unequalled power and performance. It features four corner water ports, a tapped fifth port in the front face, nitrous bosses, and dual distributor holddowns. We recommend our Power+Plus #52605 intake gaskets which have silicone sealing beads and are significantly less expensive than competitive gaskets for Vortec heads. This is one of our top selling manifolds.

Pt. No.	Application
52032	SB Chevy V8 w/Vortec Heads - Polished Finish
52033	SB Chevy V8 w/Vortec Heads - Satin Finish

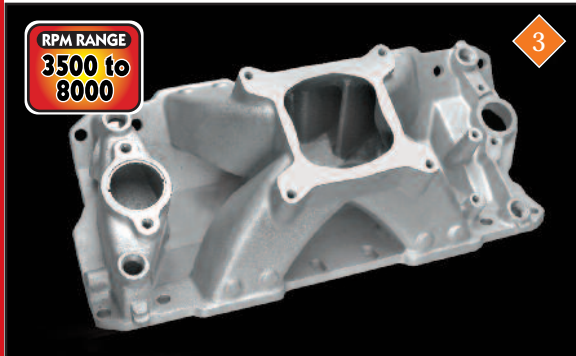

HURRICANE+PLUS™ for 1957-'95 SB Chevrolet V8*

They said it wasn't possible to improve on the standard Hurricane, the best performing single plane manifold for 23° heads. But we proved them wrong. After three years of extensive development we have a manifold that outperforms the Hurricane. Depending on the specific engine combination we have seen as much as 20 extra horsepower over the standard Hurricane. Note that this extra power is mostly showing up over 7,000 rpm. So if you aren't turning your engine in the 7,000 to 8,000 rpm range, stick with the standard Hurricane. Below 7,000 this manifold is only 3 or 4 more horsepower better. This manifold also has all the special features found in our other Hurricane manifolds. Can be ported to 1209.

Pt. No.	Application
52034	1957-'95 SB Chevy V8 - Polished Finish
52035	1957-'95 SB Chevy V8 - Satin Finish

G.M. LSX V8 Intake Manifolds

TYPHOON™



LS1/LS6 Cathedral Ports



LS2 Cathedral Ports

TYPHOON™ for LS1/LS6 and LS2

The Typhoon manifold for LSX type engines was designed to provide extra plenum area which is very advantageous on larger displacement versions of the LS1/LS6 and LS2 engines. If you have a punched out LS engine the stock manifold will not be able to do the job. Additionally if you are running a supercharger or turbocharger a plastic manifold will not survive a backfire so our aluminum Typhoon is your answer. Note that all of our LSX manifolds come complete with the fuel rail kit as shown in the photos.

We offer this manifold in three basic configurations as follows:

- A. The 52060/52061 is a direct replacement for any LS1 or LS6 intake. It has an 85MM inlet that can be enlarged for a 90MM throttle body.
- B. The 52062/52063 is a direct replacement for any LS2 intake. It has a 96MM inlet but can be enlarged to accept a 101MM throttle body.
- C. The 52064/52065 is a direct replacement for any LS1 or LS6 intake but has provision for the larger LS2 style throttle body. It also has a 96MM inlet that can be opened up to 101MM

Pt. No.	Application
52060	LS1/LS6 85MM Typhoon Manifold - Polished
52061	LS1/LS6 85MM Typhoon Manifold - Satin Finish
52062	LS2 96MM Typhoon Manifold - Polished
52063	LS2 96MM Typhoon Manifold - Satin
52064*	LS1/LS6 96MM Typhoon Manifold - Polished
52065*	LS1/LS6 96MM Typhoon Manifold - Satin

*Requires use of LS2 style throttle body

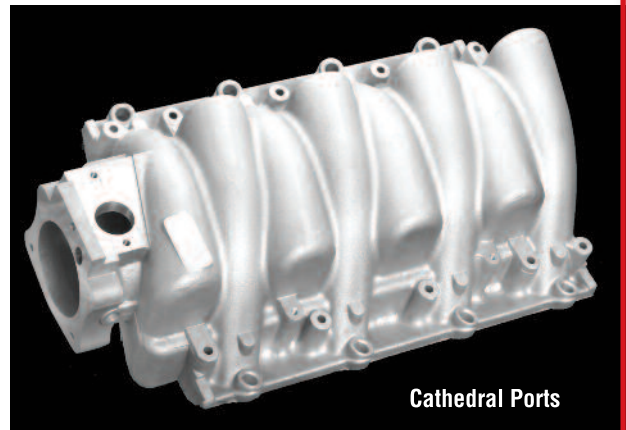

Cathedral Ports

The above photo shows what the satin finish manifold looks like. The supplied fuel rail kit that comes with the manifold is not shown in this photo. Both the LS1/LS6 and LS2 manifolds are supplied with a stainless braided line that connects to the fuel rail on one end and to your stock GM fuel inlet line on the other. A blockoff cover plate is supplied for the top front of the manifold on the LS1/LS6 style manifolds. See our other sections of this catalog for a complete listing of available LSX throttle bodies, harmonic dampers and fuel rail kits.

Big Block Chevrolet V8 Intake Manifolds

CYCLONE™ for Big Block Chevrolet V8 w/Oval Ports

This manifold is a stock replacement/street legal part for 396, 402, 427, and 454 V8's with OEM 4-bbl carb; 1965-'72 (1973 non-CA) passenger cars and 1966-'83 trucks, Suburbans and heavy vehicles, except stock equipped EGR. This manifold design includes nitrous bosses, dual distributor holddowns, and four corner water ports. This manifold also includes a special carb adapter to allow the use of aftermarket square bore carburetors. This is an excellent street performance manifold. It will not fit under the hood of Corvettes without hood modifications.

Pt. No.	Application
53000	Big Block Chevy V8 w/oval ports - Polished Finish
53001	Big Block Chevy V8 w/oval ports - Satin Finish

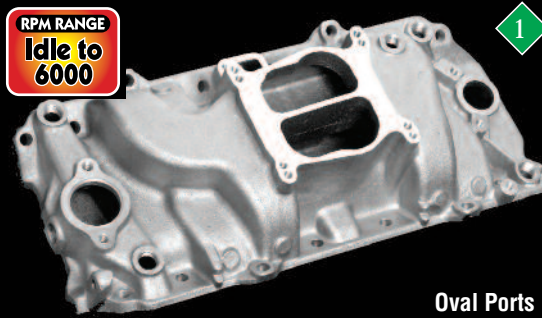

Oval Ports

CYCLONE™

CROSSWIND® for BB Chevrolet V8 w/Oval Ports

Now available for big block Chevy engines with oval ports is our popular Crosswind manifold, commonly referred to as an air gap style design. This open area under the plenum chamber allows ambient air to provide additional cooling to the intake charge which produces additional power. This extra space also helps isolate the upper part of the manifold from the transference of engine heat. Like many of our manifolds, the Crosswind features nitrous bosses, four corner water ports and dual distributor holddowns. This is our best selling manifold for big block Chevrolet engines.

Pt. No.	Application
53025	Big Block Chevy V8 w/oval ports - Polished Finish
53026	Big Block Chevy V8 w/oval ports - Satin Finish

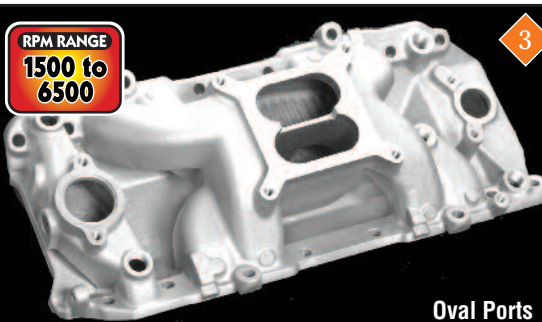

Oval Ports

CROSSWIND®

HURRICANE™ for BB Chevrolet V8 w/rectangular ports

This manifold is primarily best on big block engines in the 396, 427, 454 displacement area producing power in the 600 to 700 horsepower range. The manifold features large rectangular ports (1.63" x 2.25") along with nitrous bosses, four corner water ports and dual distributor holddowns. Use the Professional Products Power+Plus Intake Gasket #53601. This is a very affordable manifold that makes outstanding power and torque. In numerous dyno tests this manifold has proven to match or exceed the performance of equivalent models of competitive manifolds that cost substantially more money.

Pt. No.	Application
53030	Big Block Chevy V8 - Polished Finish
53031	Big Block Chevy V8 - Satin Finish

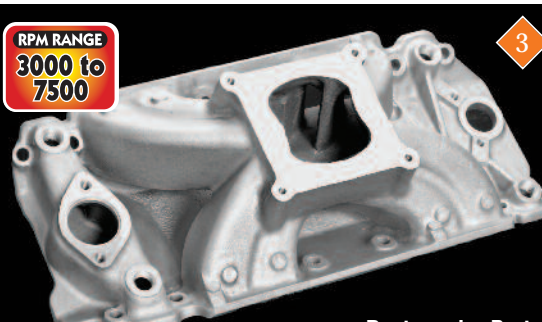

Rectangular Ports

HURRICANE™ for BB Chevrolet V8 w/oval ports

This manifold is basically the same as the 53030/53031 but has oval ports instead of rectangular ports. It features four corner water ports, dual distributor hold-downs and nitrous bosses. This is a proven design that produces outstanding torque and horsepower when used in the right engine combination. Best on engines with displacement in the 396 to 454 range producing from 600 to 700 horsepower. This is a terrific manifold and despite its low cost, it will equal or exceed the power produced by any similar competitive manifold.

Pt. No.	Application
53036	Big Block Chevy V8 w/oval ports - Polished Finish
53037	Big Block Chevy V8 w/oval ports - Satin Finish

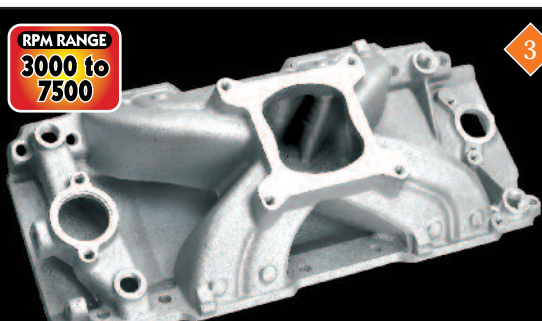

Oval Ports

HURRICANE™

HURRICANE™ for BB Chevrolet V8 w/rectangular ports Accepts Dominator style carburetor

This manifold is very similar in design to our 53030/53031 Hurricane but has a carb flange that accommodates a Dominator (4500) type carburetor. This manifold also has pads on the ports which can be drilled and tapped for nitrous nozzles or it is available from Professional Products machined for injector nozzles. Use the Professional Products Complete Fuel Rail Kit #10626 with this manifold when being utilized in a port style fuel injection system.

Pt. No.	Application
53032	BB Chevy V8 w/machined injector ports - Polished
53033	BB Chevy V8 w/machined injector ports - Satin
53034	BB Chevy V8 w/rectangular ports - Polished
53035	BB Chevy V8 w/rectangular ports - Satin

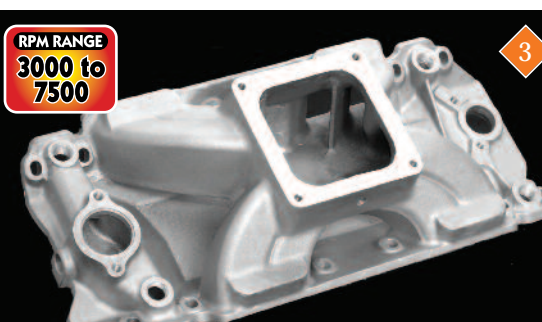

Rectangular Ports

Small Block Ford V8 Intake Manifolds

TYPHOON™

RPM RANGE
1500 to
6500



1

TYPHOON™ for Small Block Ford except 351 Windsor

This is an ideal street performance manifold that delivers strong performance across nearly the entire power band while maintaining good throttle response at any speed. Will not fit 255, Boss 302, or 351W engines. It will also fit 1983 and later 5.0L Mustangs and will work with cruise control.

Pt. No.	Application
54000	Small Block Ford V8 - Polished Finish
54001	Small Block Ford V8 - Satin Finish

This manifold is a stock replacement/street legal part for 289 1965-'66 Cobra V8s with OEM 4V carb. Certain exempt aftermarket carbs may also be legal.

RPM RANGE
1500 to
6500

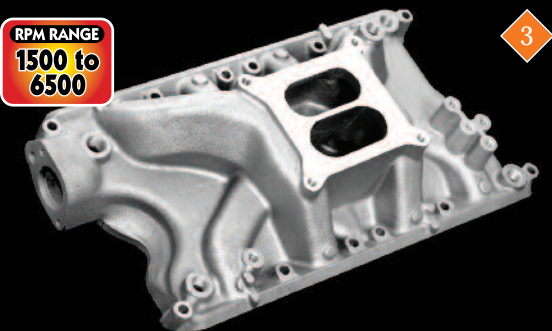

3

TYPHOON™ for Small Block Ford 351W

The Typhoon for 351W engines is a great street manifold for this engine. It provides good top end power without sacrificing bottom end torque. Its long runner, dual plane design provides the best of both worlds. This manifold performs best with an aggressive street cam. For street, use a 600-750 CFM vacuum secondary or double pumper carburetor. For competition, use a 750-850 double pumper carb. One major feature on this manifold not found on competitive models is a rear water crossover passage which promotes a cooler running engine.

Pt. No.	Application
54022	Small Block Ford 351W - Polished Finish
54023	Small Block Ford 351W - Satin Finish

CROSSWIND®

RPM RANGE
1500 to
6500



3

CROSSWIND® for Small Block Ford except 351 Windsor

To create this manifold we took our popular 54000/54001 Typhoon manifold for small block Fords and modified it to produce an open area under the plenum (commonly called an air gap). This then became our Crosswind model. This design allows ambient air to pass beneath the plenum which has a cooling effect on the incoming fuel/air charge thus producing more power. This isolation also keeps engine heat from transferring into the plenum chamber. This manifold has several unique features such as a rear water crossover passage which contributes to a cooler running engine, nitrous bosses and four corner water ports.

Pt. No.	Application
54025	Small Block Ford V8 - Polished Finish
54026	Small Block Ford V8 - Satin Finish

Will not fit 255 CID V8 or Boss 302.

HURRICANE™

RPM RANGE
3500 to
8000

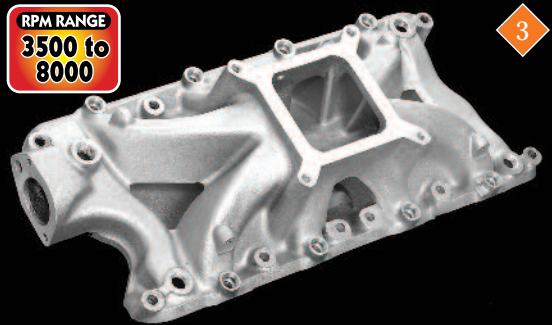

3

HURRICANE™ for SB Ford V8 except 351W

The Hurricane manifold for SB Fords can be used for racing applications or for serious street performance. It has a number of unique features such as a rear water crossover passage, nitrous/injector bosses, and four corner water ports. This manifold is available with the injector bosses machined for injectors. The port size on this manifold is 1.06" x 1.94" which is somewhat larger than some competitive manifolds. Use Fuel Rail Kit #10607 with EFI manifold.

Pt. No.	Application
54030	Small Block Ford V8 - Polished Finish
54031	Small Block Ford V8 - Satin Finish
54038	Small Block Ford V8 - With EFI - Polished Finish
54039	Small Block Ford V8 - With EFI - Satin Finish

RPM RANGE
3500 to
8000

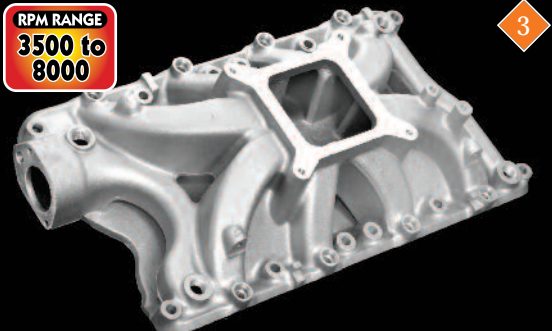

3

HURRICANE+PLUS™ for SB Ford V8 351W

The Hurricane manifold for Ford 351W engines has a number of features not found in similar competitive manifolds. It has a bridged rear water crossover passage which contributes to a cooler running engine. It also comes with injector bosses that can be drilled and tapped for nitrous nozzles or can be purchased from Professional Products with the injector bosses machined. We also offer a Complete Fuel Rail Kit (#10607) for the EFI version of this manifold.

Pt. No.	Application
54032	Small Block Ford V8 - Polished Finish
54033	Small Block Ford V8 - Satin Finish
54034	Small Block Ford V8 - With EFI - Polished Finish
54035	Small Block Ford V8 - With EFI - Satin Finish

5.0L Ford Mustang Intake Manifolds

This is a proven manifold with thousands sold for the popular 5.0L Mustang V8 engine. Note that use of our 54100 spacer allows removal of valve cover without taking the plenum chamber off of the manifold.

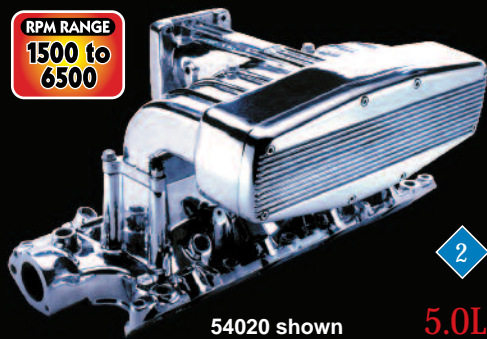

54020 shown 5.0L

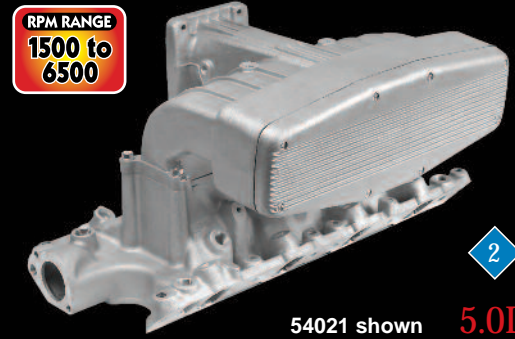

54021 shown 5.0L

TYPHOON™ for 5.0L Ford and 351W

The Typhoon Manifold System for 5.0L and 351W Fords is an ideal performance upgrade for your Mustang or other vehicle with one of these engines. The 5.0L System is sold as a complete kit with both the lower manifold and upper plenum in one package. However, if you have a 351W engine, you need to buy the 351W manifold and the upper plenum separately. Note that if your vehicle is a 1994 or 1995 Mustang, you will also need the optional Elbow Adapter and EGR Adapter available from Professional Products (listed below) as well as a strut tower brace available from Ford (M-20201-A51) or Edelbrock (#5225).

Note that our Upper Plenum will bolt to an Edelbrock #3821 or #7126 manifold. If a customer already has an Edelbrock setup it is an easy and economical swap to bolt on one of our polished upper plenum units.

Pt. No.	Application
54020	Complete System for 5.0L Ford - Polished Finish
54021	Complete System for 5.0L Ford - Satin Finish
54122	Manifold only for 5.0L Ford - Polished Finish
54123	Manifold only for 5.0L Ford - Satin Finish
54124	Upper Plenum - 5.0L or 351W - Polished Finish
54125	Upper Plenum - 5.0L or 351W - Satin Finish
54126	Manifold only for 351W - Polished Finish
54127	Manifold only for 351W - Satin Finish
54100	Phenolic Spacer - 1/2" thick
54150	Elbow Adapter for 1994-'95 - Polished Finish
54151	Elbow Adapter for 1994-'95 - Satin Finish
54152	EGR Adapter for 1994-'95

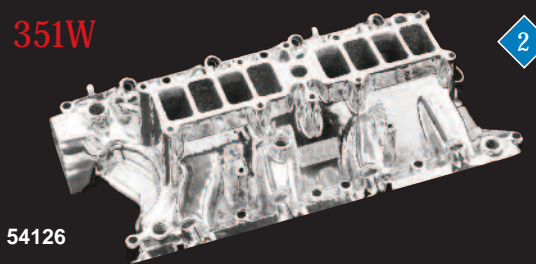

54126

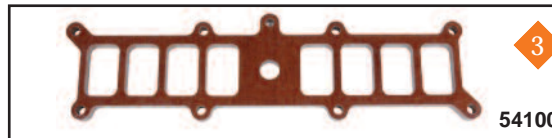

54100

The Phenolic Spacer raises the Upper Plenum by 1/2". This provides heat isolation plus clearance for removing the valve cover. The two parts shown to the right are required when installing one of these systems on a 1994 or '95 Mustang. A strut tower brace is also required, available from Ford Racing (M-20201-A51) or Edelbrock (#5225).

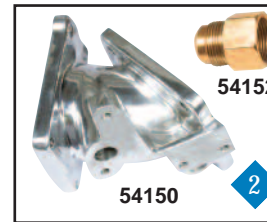

54150

54152

4.6L 2V Ford V8 Intake Manifolds

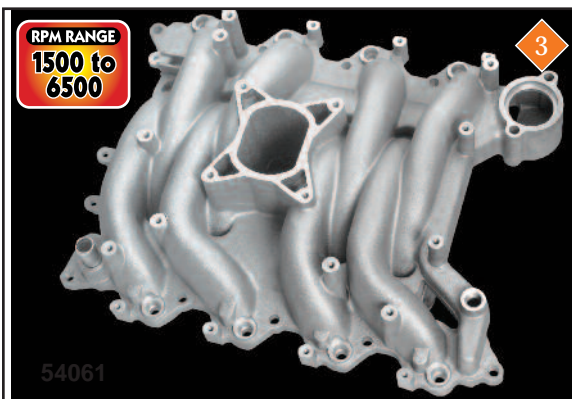

54061



54110

The 54110 Adapter Kit (left) will allow the installation of the Professional Products 54060/54061 Intake Manifold (or any other 4.6L 2V manifold) onto a Triton 5.4L 2V engine. The wider 5.4 2V needs these adapter plates to allow this swap to take place.



54154

TYPHOON™ for 4.6L 2V Ford V8

This manifold is an ideal street manifold. When used with stock cams it can produce good mid-range torque improvements. With cams that will allow the engine to rev to at least 6,300 RPM, as much as 20 additional horsepower is available with this manifold. This manifold is a bolt-in replacement for the stock manifold on 1999-'04 engines but can be used on earlier engines if '99 or later PI heads are used. We also offer an adapter kit that will allow this manifold to be used on a 5.4L 2V engine. We also have an Upper Plenum, Throttle Bodies, and Fuel Rail Kits for these engines. The Center Plenum can be modified by those tuners who feel they can improve the flow of this manifold.

Pt. No.	Application
54060	4.6L 2V Ford V8 Typhoon Manifold - Polished
54061	4.6L 2V Ford V8 Typhoon Manifold - Satin Finish
54110	Adapter Plates for 4.6L manifold to 5.4L 2V heads
54154*	Upper Plenum - Polished
54155*	Upper Plenum - Satin
54156	Stainless Alternator Bracket (Comes w/manifold kit)
54165	Upper Plenum to Manifold Gasket

*This Upper Plenum is a natural companion part when used with the 54060 or 54061 Intake Manifold for maximum performance.

TYPHOON™

TYPHOON™

318*/340/360 Chrysler V8 Intake Manifolds

CROSSWIND™

RPM RANGE
1500 to
6500

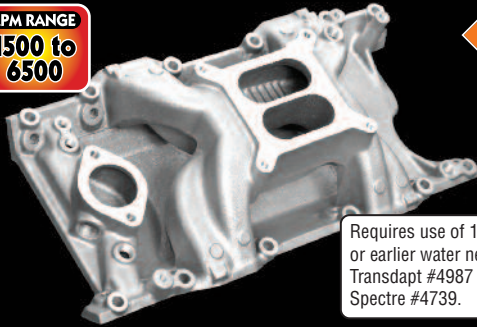

3

Requires use of 1975 or earlier water neck. Transdapt #4987 or Spectre #4739.

CROSSWIND® for 318*-340-360 Chrysler V8

This manifold is designed with two sets of bolt holes so that it will fit both the early style Chrysler heads and the later Magnum heads. This is an air gap style design which provides air space under the plenum which helps cool the intake charge and produce more power. This manifold includes nitrous bosses, an extra rear water port and is available in either a polished or satin finish. This is a terrific all around high performance street manifold. Use our intake manifold gasket #55600 (except Magnum) and #55601 for Magnums.

Pt. No.	Application
55025	318/340/360 Chrysler V8 - Polished Finish
55026	318/340/360 Chrysler V8 - Satin Finish

*Fits 318's equipped with 340 or 360 cylinder heads.

Pontiac V8 Intake Manifolds

CROSSWIND®

RPM RANGE
1500 to
6500

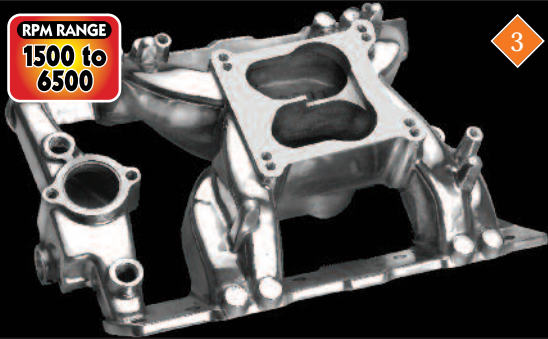

3

CROSSWIND® for 1965-'79 325-455 Pontiac

This is an outstanding manifold for high performance street Pontiac engines. Unlike similar competitive manifolds, the Crosswind allows unlimited ambient air-flow under the plenum and around the runners which helps create a cooler incoming air/fuel charge which produces additional power. This manifold is also available with machined injector bores. Use our Complete Fuel Rail Kit #10618 with this manifold for fuel injection applications.

Pt. No.	Application
56025	326-455 Pontiac V8 - Polished Finish
56026	326-455 Pontiac V8 - Satin Finish
56027	326-455 Pontiac V8 - EFI - Polished Finish
56028	326-455 Pontiac V8 - EFI - Satin Finish

HURRICANE™

RPM RANGE
3000 to
7500

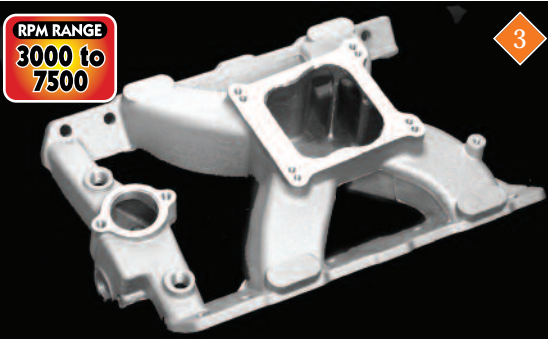

3

HURRICANE™ for Pontiac V8

This manifold was developed in conjunction with Pontiac specialist Pacific Performance and porting expert Dave Bishop. It is a single plane manifold that will fit under all Pontiac hoods including the Trans Am "Shaker" hood. It accepts a stock Quadrajets carb but we also include an adapter plate for standard square bore carbs. This manifold is designed to work with cylinder heads up to 300 CFM. It is also available machined for injectors. Use Fuel Rail Kit #10625.

Pt. No.	Application
56030	1965-'79 326-455 Pontiac V8 - Polished Finish
56031	1965-'79 326-455 Pontiac V8 - Satin Finish
56032	1965-'79 326-455 Pontiac V8 - EFI - Polished Finish
56033	1965-'79 326-455 Pontiac V8 - EFI - Satin Finish

Oldsmobile V8 Intake Manifolds

CROSSWIND®

RPM RANGE
1500 to
6500

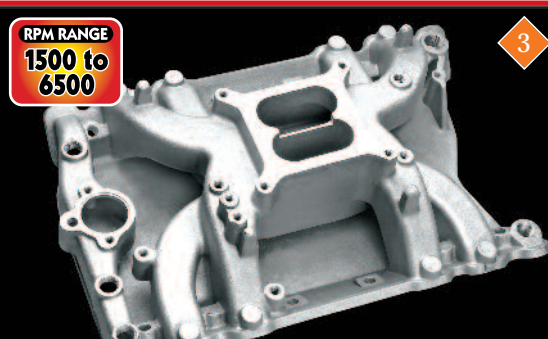

3

CROSSWIND® for 400-425-455 Oldsmobile

This is the only available high rise high performance dual plane manifold for this engine. It is an inch and a quarter taller than competitive manifolds thereby producing more power. The Crosswind design provides an air gap under the plenum chamber which helps cool the intake charge providing additional power. Available with machined injector bosses. Use our Complete Fuel Rail Kit #10619 with this manifold in injected applications. NOTE: Hood clearance must be checked as this manifold is approximately 1.25" taller than a similar stock intake manifold.

Pt. No.	Application
57025	Oldsmobile V8 - Polished Finish
57026	Oldsmobile V8 - Satin Finish
57027	Oldsmobile V8 - EFI - Polished Finish
57028	Oldsmobile V8 - EFI - Satin Finish

1st Place

BEST ENGINEERED NEW PRODUCT

POWERFIRE I

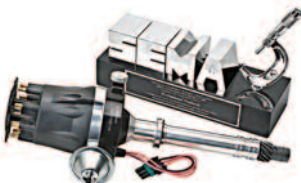

POWERJECTION I
BEST PERFORMANCE
PRODUCT R.U.



POWERJECTION III
BEST PERFORMANCE
PRODUCT R.U.

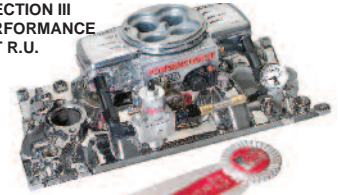

Professional Products POWER+PLUS® Manifold Features



Dual Distributor Holddowns

Sometimes the standard single distributor holddown is difficult to access. So we have provided dual distributor holddowns on most Power+Plus Chevy intake manifolds, which gives you an optional position. And on our 52030 and 52031 Racing Manifold, you can use two hold-downs for extra protection against distributor rotation in racing applications.

Carburetor Adapter Plate

Many Chevy manifolds accept the stock Rochester Quadra-Jet spread-bore carb. But if you want to use one of the popular Holley or Edelbrock square bore carbs, you have to spend more bucks for a carb adapter plate. Power+Plus spread-bore manifolds include adapter plates and gaskets to accept square bore carbs. Adapter plates included with manifold.

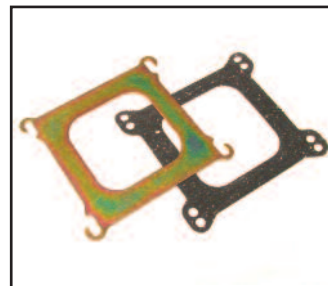

Four Corner Water Ports

Most of our performance manifolds feature two extra water ports at the rear of the manifold, a feature normally only found in manifolds costing hundreds more. Some enthusiasts have found that plumbing a line between these two rear ports can reduce engine overheating. Many racers also find these ports to be an advantageous special feature for plumbing special additional water lines.



Nitrous Bosses

If you want to run nitrous with the injectors mounted directly in the ports, Power+Plus Manifolds provide a simple solution. Many of our manifolds include cast-in nitrous bosses which provide the extra thickness not found in most competitive manifolds without spending a lot more money. This extra thickness is necessary to provide the proper amount of thread engagement. All you have to do is drill and tap the bosses to accept any manufacturer's nitrous injectors.

Special Manifold Adapters

All Power+Plus Street and High Performance Street Manifolds for small block Chevys (except Vortec) come with special adapters that allow these manifolds to fit the '87-'95 cast iron heads. If you have '86 or earlier heads, or '87-'95 aluminum heads, our manifolds bolt right on without the adapters. For '87-'95 cast iron heads, drop the adapters in the four slotted holes and bolt up the manifold with no fuss and no special tools required.

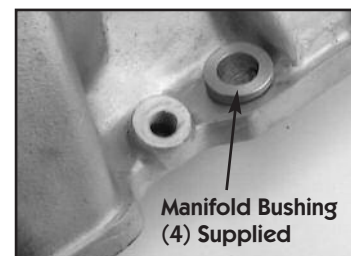

Manifold Bushing (4) Supplied

Other Special Features:

- All manifolds are cast in permanent steel molds, not sand.
- Many Ford manifolds have a rear water crossover passage.
- All ports very accurately positioned due to advanced permanent mold casting techniques. Not sand cast as other companies.
- Before packaging, every tapped hole in each manifold is chased to clear out machining and polishing residue and to assure the threads are ok. Each manifold is pressure tested for leaks.

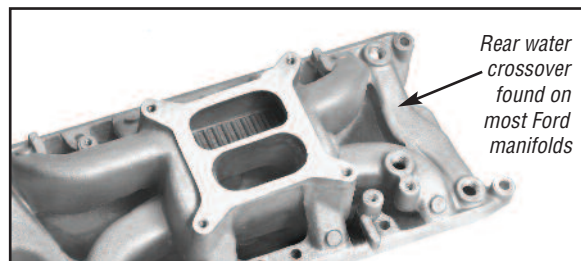

Rear water crossover found on most Ford manifolds

Acura Intake Manifolds

WHIRLWIND® for 1997-'01

Acura Type R

The Whirlwind for Acura Type R was developed in conjunction with AEBS, a leading Honda/Acura specialist. The plenum chamber is enlarged and also extends past the last port runner to provide adequate flow when using a supercharger, turbocharger or nitrous. In some respects this manifold is similar to the popular JDM manifold but will outperform it and costs substantially less. The manifold has a 65MM inlet but can be ground out larger if needed. See our line of compatible large bore precision throttle bodies in the throttle body section of this catalog. Dampers and fuel rails are also available from us for this engine.

Pt. No.	Application
59000	Acura Type R Manifold - Polished Finish
59001	Acura Type R Manifold - Satin Finish



RPM RANGE
2000 to
8000

3

WHIRLWIND®

MANIFOLDS for EFI Applications

The manifolds shown on this page are available with machined bosses for port injection applications. All of these manifolds also

have matching fuel rail kits which are shown on page 31. For additional fuel injection components, see the EFI section of this catalog.

**1957-'95
SB Chevy**

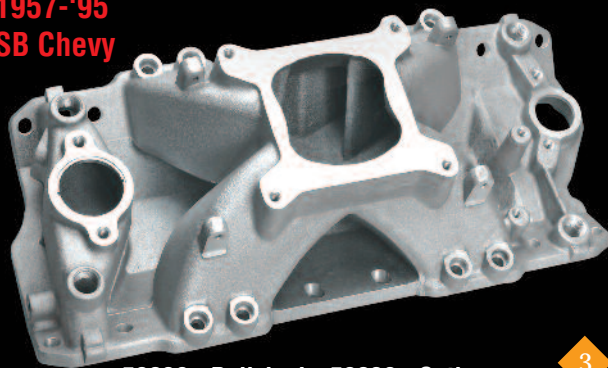

52038 - Polished • 52039 - Satin



**1965-'79 - 325-455
Pontiac V8**



56032 - Polished • 56033 - Satin



**289-302 5.0L
SB Ford**

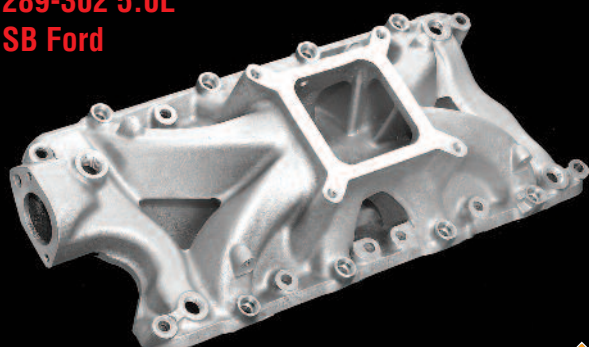

54038 - Polished • 54039 - Satin



**1965-'79 - 325-455
Pontiac V8**



56027 - Polished • 56028 - Satin



**351 Windsor
SB Ford**

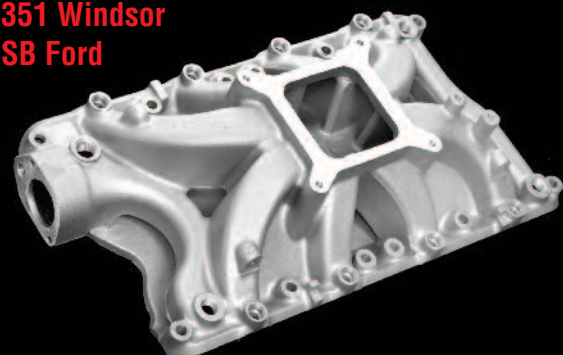

54034 - Polished • 54035 - Satin



**400-425-455
Oldsmobile V8**

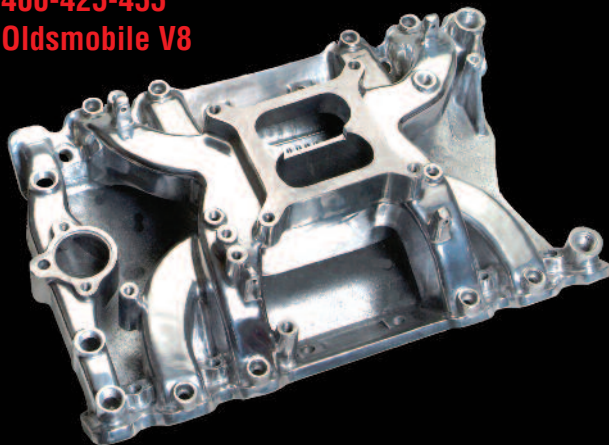

57027 - Polished • 57028 - Satin



**396-427-454-502
BB Chevy**

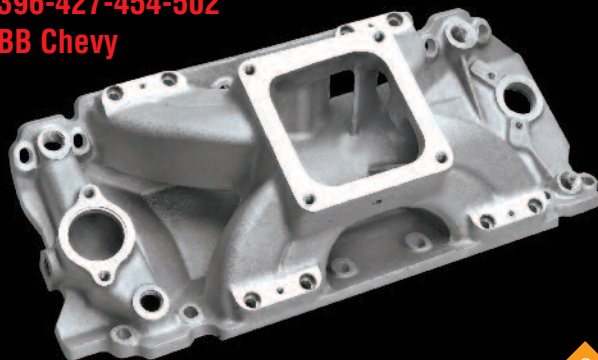

53032 - Polished • 53033 - Satin



Left: Currently, our only EFI style big block Chevy manifold has a Dominator carburetor flange. To use our 4150 style throttle body or 4150 style carburetor on this manifold requires the use of a special adapter shown at right. See page 26 for a complete listing of available adapters.

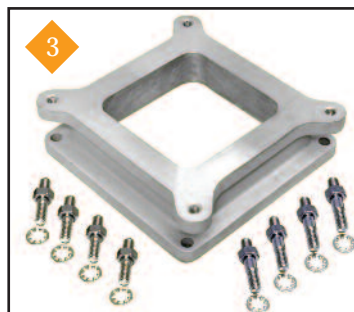

Intake Manifold Technical Specifications

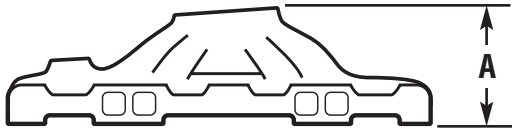

Manifold Height

Note: Dimension "A" is measured from bottom machined surface of manifold to the highest portion of the carburetor flange or plenum housing.

Port Dimensions

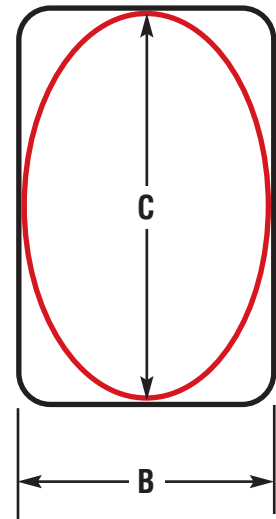

On any manifold that is taller than your stock manifold, it is extremely important to check for proper hood clearance before installing the manifold to avoid sheet metal damage to your hood.

Manifold Part No.	Dim. A	Dim. B	Dim. C	Pro Products Gasket	Fel-Pro Gasket
52000/52001/52002/52008/52009	4.05	1.19	1.90	#52600	#1204 or #1256
52003/52006/52007	4.25	1.18 ¹	2.06	#52605	#1255
52010/52011/52012/52013/52014 52016	4.40	1.25	2.02	#52600	#1204 or #1256
52020/52021/52022/52025/52026	4.65	1.25	2.09	#52601	#1205
52027/52028	4.65	1.18 ¹	2.06	#52605	#1255
52030/52031/52032/52033/52034 52035/52036/52037/52038/52039	6.06	1.11 ²	1.80	#52601	#1205, #1206, #1207 #1208, or #1209 ⁶
52060/52061/52062/52063 ⁴ 52064/52065 ⁴ & 52070 thru 52077 ⁴	6.44	1.09	2.70	#52610	
53000/53001/53002	5.75	1.82	2.05	#53600	#1210 or #1212
53025/53026	5.22	1.82	2.05	#53600	#1212
53030/53031	6.16	1.63	2.25	#53601	#1211 or #1275
53034/53035	5.88	1.75	2.35	#53601	#1211 or #1275
53036/53037	5.87	1.82	2.05	#53600	#1212
54000/54001/54002	4.12	1.06	1.87	#54600	#1250
54020/54021 Dimension to top of plenum	11.05	1.06	1.87	#54600	#1250
54022/54023/54024	5.12	1.06	1.87	#54600	#1250
54025/54026	4.12	1.06	1.87	#54600	#1250
54030/54031	5.39	1.06	1.94	#54600	#1250
54032/54033/54034/54035	5.68	1.18	1.91	#54600	#1250
54060/54061 ⁴	4.30	1.45	1.45	#54601	N/A
54122/54123	5.47	1.06	1.87	#54600	#1250
54126/54127	5.62	1.06	1.87	#54600	#1250
55025/55026	5.50	1.08	2.16	#55600 ³	#1213 ³
56025/56026/56027/56028	Note 5	1.10	2.06	N/A	#1233
56030/56031	Stock	1.10	2.06	N/A	#1233
57025/57026/57027/57028	6.50	1.32	2.38	N/A	Mr. Gasket #404

Note:

53000/53001/53002/
52025/53026/53036/
53027 Big Block Chevys have
oval ports (red line).

52006/52007/52003/
52027/52028/52032/
52033 SB Chevy Vortec heads
have tapered ports.

52060 through 52077 have
GM Cathedral ports

54060/54061 4.6L Ford heads
have round ports.

All other heads have rectangular
ports.

The ports on Professional
Products manifolds are typically
made closer to the actual
size of the gasket compared to
other competitive manifolds.
This reduces the necessity of
port matching. Or if port
matching is desired, it will
require less grinding to get a
proper match.

NOTES:

Note 1. Measured at the widest area of the port which is at the bottom. The top of the Vortec port is 1.06".

Note 2. The ports on all SB Chevy Hurricanes are purposefully left smaller to allow a wide range of port sizes to match various head configurations. The port runners are typically much larger than the port openings.

Note 3. Use this gasket on non-Magnum engines. On Magnum engines use Professional Products gasket #55601 or Mopar Performance #P-4876049.

Note 4. Gaskets are supplied with manifold on these part numbers.

Note 5. This manifold is 1.25" taller than the stock intake manifold.

Note 6. The 52030 and 52031 Hurricanes can be ported out to a Fel-Pro #1207 intake gasket. All other small block Chevy Hurricanes can ported out to a Fel-Pro #1209 intake gasket.

Manufacturing Processes

All Power+Plus Manifolds are cast in steel dies rather than in sand molds as used by all other manifold manufacturers. This type of tooling costs two or three times what conventional sand cast patterns cost, but the finished product is worth this additional expense. And because the cores (which form the internal ports and water passages) are mounted in steel instead of sand during the casting process, there is no chance of any core shifts, which can sometimes go undetected in sand castings. Core shifts can cause misalignment between the ports and the heads, or even actual air or water leakage. That is one problem you won't have to worry about with Power+Plus. Each and every Power+Plus manifold is subjected to a very thorough pressure test that will detect any air or water leakage. We find any problems first so you don't have to go to the effort of installing your manifold only to find out that it leaks. Power+Plus Manifolds are manufactured in a factory which produces OE aluminum manifolds for major Japanese and European auto makers, so you know the quality is there. That same OE level quality can be found in every Power+Plus Manifold. And this high quality level is brought to you among the most affordable prices in the industry.

Engine Accessories

NEW



BLACK

Pro Drive Kits

Black Pro Drive for SB Chevy

Part No. 20500 for complete set

- Satin Finish Aluminum Long Water Pump
- Satin Finish 100 Amp Alternator (Black Fan)
- Black Alternator Bracket Set
- Black Power Steering Pump & Pulley
- Black Water Pump Pulley (2) Groove
- Black Crank Pulley (3) Groove

Chrome Pro Drive for SB Chevy

Part No. 20510 for complete set

- Chrome Aluminum Long Water Pump
- Chrome 100 Amp Alternator
- Chrome Alternator Bracket Set
- Chrome Power Steering Pump & Pulley
- Chrome Water Pump Pulley (2) Groove
- Chrome Crank Pulley (3) Groove

Note: These two kits will work on any long water pump style small block Chevy (1969-1987) or earlier SB Chevy blocks fitted with long water pumps.

Dress up your 1969 to 1987 Small Block Chevy with either our Chrome Pro Drive Kit or our Black Pro Drive Kit. These kits are for long water pump engines but if you currently have an earlier short water pump engine,* either of these kits can be used to convert your early engine to the later style long water pump engine. That's assuming you have enough room in the front of your engine for the extra length. The long water pump is approximately 1-3/8" longer than a short water pump.

**Short water pumps were used on 1955-'68 passenger cars, 1969-'82 Corvettes, and 1955-'72 light duty trucks.*

NEW



CHROME

Small Block Chevy

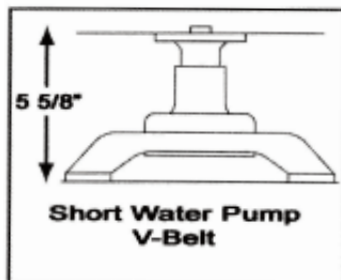

Small Block Chevy

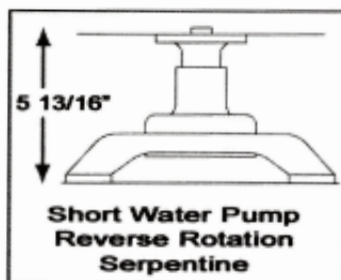

Small Block Chevy

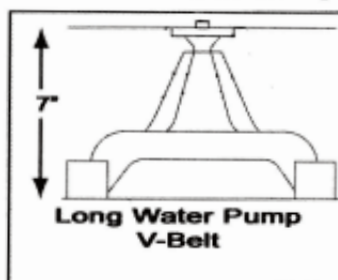

Note: The Pro Drive Kits are intended only to be used with V-belt applications. Will not work with serpentine accessory drive belts.

ENGINE ACCESSORIES and Manifold Accessories



12-Point Stainless Engine Bolt Kits

These premium stainless Bolt Kits are available for three popular engines and are also offered as just intake manifold sets. The bolt heads are polished. The various bolts in each engine kit are grouped together and labeled for size and length plus the specific use is given such as intake manifold, pan, alternator, water pump, distributor, timing cover, fuel pump and valve covers. Due to wide variations of SB Ford engines, the 54130 kit may contain some bolts not needed or may not include every bolt required on some engines.

Pt. No.	Application
52120	SB Chevy & Pontiac Intake Manifold Bolt Set
52130	SB Chevy Complete Engine Bolt Kit
53120	BB Chevy Intake Manifold Bolt Set
53130	BB Chevy Complete Engine Bolt Kit
54120	SB Ford Intake Manifold Bolt Set
54130	SB Ford Complete Engine Bolt Kit

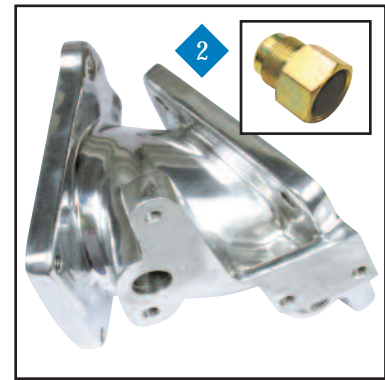

Elbow Adapter

These two parts are required when a 54020/54021 Professional Products Typhoon Manifold System is installed on a 1994-'95 Mustang. These parts provide clearance from the stock strut brace but still requires an aftermarket strut brace. Use Ford Racing #M-20201-A51 Strut Tower Brace or Edelbrock #5225 Strut Brace.

54150	Elbow Adapter Polished
54151	Elbow Adapter Satin
54152	EGR Adapter Fitting

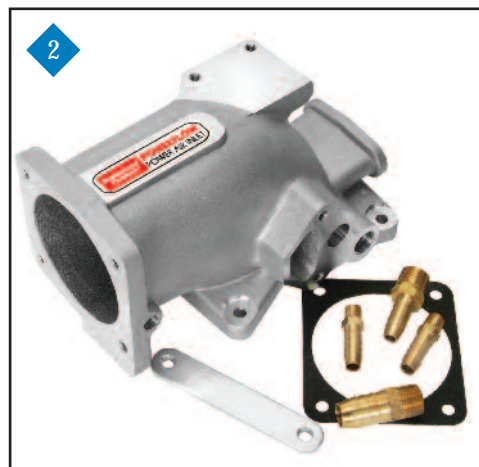

Upper Plenum Assembly for 4.6L 2V Mustang

The Upper Plenum is a direct bolt-on for all 4.6L 2V Mustangs and provides an additional 100 CFM of air flow over the stock unit. The inlet opening is 75MM but can be used with stock throttle bodies or our 70 or 75MM throttle bodies. This is an inexpensive bolt-on that provides instant additional performance. Install it in about 30 minutes with ordinary hand tools.

54154	Upper Plenum Polish
54155	Upper Plenum Satin

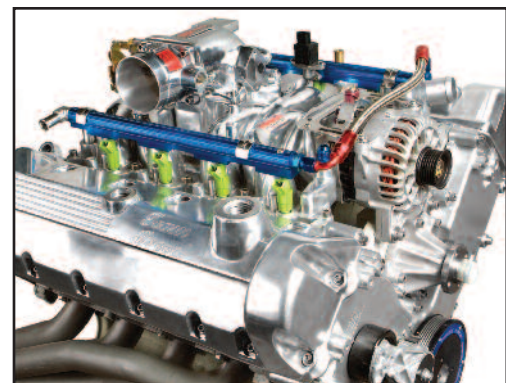

Ford 4.6L 2V engine with 54060 Manifold, 54154 Upper Plenum, 69221 Throttle Body and 90011 Harmonic Damper, all from Professional Products.



Stainless Steel



Zinc Plated Steel

Throttle Cable Bracket Kit for SB Chevy

This Bracket Kit is designed for use on 1978 and earlier small block Chevys. It provides a mounting for the throttle, cruise control, and transmission kick-down cables. The Bracket Kit will fit on most manifolds and features wide adjustability. Each of the three cable brackets mount independently and can be positioned forward or backward by sliding the bracket in the slotted holes before tightening. The Bracket Kit is offered in either a zinc plated steel version or a polished stainless steel version. This kit significantly simplifies the task of connecting these cables.

52125	Throttle Cable Bracket Kit in polished stainless steel
52126	Throttle Cable Bracket Kit with zinc plated finish

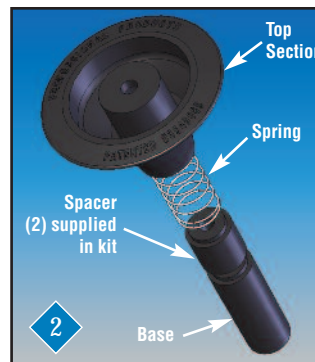

AIRFLO™ Air Cleaner Insert

The AIRFLO is an amazingly simple device that will work on Holley or Demon four barrel carbs, with or without a choke tower and any round air cleaner with an inside space of 3.3" to 6.4". The AIRFLO works on a very simple principle. As air flows into the air cleaner, the air currents collide in the center and are slowed making their entry into the carburetor. The AIRFLO solves this problem by providing a smooth transition from the side entry right down into the carb. Tests have shown anywhere from 7 to 10 HP and as much as a tenth better e.t.

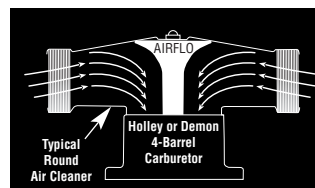

20001	Holley/Demon w/o choke
20003	Holley 4-bbl w/choke
20004	Demon 4-bbl w/choke

ENGINE ACCESSORIES and Manifold Accessories



POWER+PLUS® Gasket Sets

All Power+Plus Intake Gasket Sets feature silicone beading around the intake ports and water ports for additional sealing. These sets do not include end rail gaskets. Use RTV type gasket sealer.

Pt. No.	Application	Compare*to:
52600	SB Chevy (1.23" x 1.99" port size)	Fel-Pro #1256
52601	SB Chevy (1.28" x 2.09" port size)	Fel-Pro #1205
52605	SB Chevy Vortec (Tapered port)	Fel-Pro #1255
52610	GM LS1/LS2/LS6	Fel-Pro #1312-3
53600	BB Chevy w/oval ports	Fel-Pro #1212
53601	BB Chevy w/rectangular ports	Fel-Pro #1211
54600	SB Ford 289/302/351W/5.0L	Fel-Pro #1250
54601	4.6L 2V & 5.4L 2V Ford V8	
54160	Replacement Gaskets for 54020/54021/54124/54125 (except intake gaskets)	
54165	Upper Plenum to Manifold Gasket for 4.6L 2V Ford	
54170	Replacement Gaskets for 54060/54061 (except intake gaskets)	
55600	SB Chrysler (except Magnum)	Fel-Pro #1213
55601	SB Chrysler Magnum	Mopar #P4875049

*Comparison refers only to port configuration.

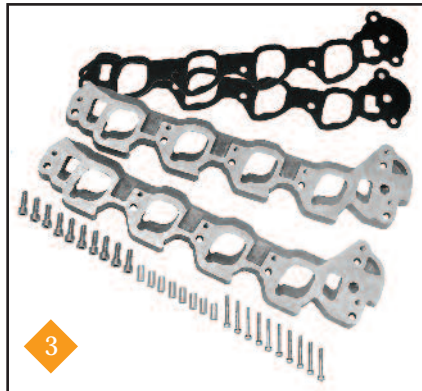

4.6L 2V to 5.4L 2V Adapter Plate Kit

Many Mustang owners are replacing their stock 4.6L 2V engine with the larger 5.4L 2V truck engine. However there are no aftermarket performance manifolds for this engine. Now with this Adapter Plate Kit you can bolt on our popular 54060/54061 Typhoon manifold or any other 4.6L 2V performance manifold to the 5.4L 2V engine. Kit includes adapter plates, coil spacers, gaskets and necessary hardware.

54110 4.6L to 5.4L Manifold Adapter Plate Kit



EGR Adapter

Use with our 52008/52009 manifold to solve clearance issues with valve covers or carburetors.

52115 EGR Adapter Kit - Polished

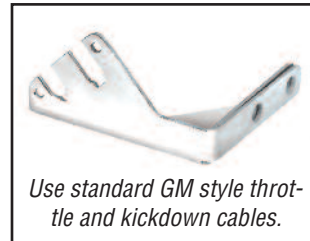

Use standard GM style throttle and kickdown cables.

Throttle Cable Bracket

This stainless bracket bolts to our 52060-52065 LSX Intake Manifolds and also our 72012/72013 Snorkle.

52200 S/S Throttle Cable Bracket



52110



52112

Carb Stud Kit

The kits include stainless steel studs, nuts and washers. Bottom of stud is 5/16-18 thread and top of stud, and nut, is 5/16-24 thread. Rounded crown on top of stud makes starting nuts easy.

20150 1.700" Long Stud Kit
20151 2.250" Long Stud Kit

Adapter Bushings

These Bushings are supplied standard with all SB Chevy manifolds (except Vortec style) and are available as replacement items in case you might lose one or more.

52110 Angle Bushing
52112 Straight Bushing



Replacement Throttle Body Gasket Sets

Pt. No.	Application
69400	For 69200 through 69205
69401	For 69210 through 69215 plus 69232 and 69233
69402	For 69220 through 69225
69403	For 69226 and 69227
69410	For 69600, 69601, 69604, 69605
69411	For 69602, 69603, 69606, 69607
69415	For 69700 through 69707
69416	For 69724 through 69728
69417	For 69728 through 69735

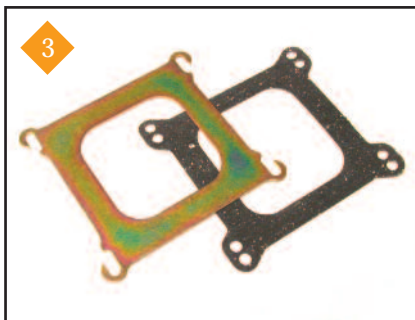

Carburetor Adapter Plate & Gasket

This Adapter Plate is used when using a square bore carburetor on a spread bore manifold. While a square bore carb looks like it will bolt directly to a spread bore manifold, without this plate and gasket there is a possibility of a vacuum leak. So the plate is inexpensive insurance. Note that this Adapter Plate is supplied in all Professional Products manifolds that come with a spread bore carburetor flange.

52111 Manifold Adapter Plate Kit



Carbretor Adapter - 4150 to 4500

This series of adapters allow the use of Dominator style carbs on 4150 manifolds and 4150 style carbs on Dominator manifolds. Available in either a satin or polished finish. Note that use of this adapter on our big block Hurricane EFI manifold allows the use of a 4150 throttle body.

20100 4150 Carb to 4500 Manifold - Satin
20101 4500 Carb to 4150 Manifold - Satin
20102 4150 Carb to 4500 Manifold - Polished
20103 4500 Carb to 4150 Manifold - Polished

ENGINE ACCESSORIES and Manifold Accessories

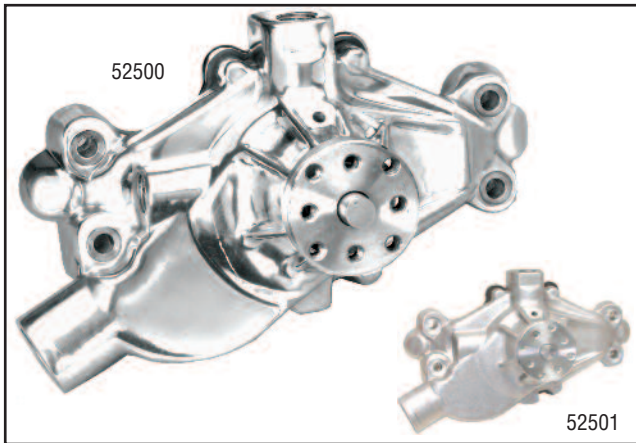

POWERFLOW™ - SB Chevy Water Pump

This short style cast aluminum Water Pump for SB Chevy is a high quality product that has been well received in the marketplace. It features a high flow impeller design, a heavy duty double shaft bearing, and dual bolt patterns on the pulley flange to accept all popular fan designs. This is a great water pump produced by an O.E. level pump manufacturer specifically for Professional Products. This high level pump is a great addition to any street rod, street machine, or custom car. It is supplied with extra gaskets if needed to space out to clear some aftermarket timing covers. This is a permanent mold aluminum casting which provides an outstanding polished finish without porosity or other unsightly flaws. Available in a highly polished finish or in an attractive satin finish.

Pt. No.	Description
52500	Small Block Chevrolet Short Style Water Pump - Polished
52501	Small Block Chevrolet Short Style Water Pump - Satin

EFI Snorkel Inlet

This Snorkel Assembly is unlike any of the competition. This one can be rotated in 15° increments which allows you to position it to avoid interference with any other engine components. Competitive models can normally only be positioned either in line with the engine or at 90° to it. The rotating seal area is handled by an o-ring. The Snorkel Assembly by itself will accept throttle bodies with LS2 bolt patterns. Various adapters are also available that will permit the use of LS1 style throttle bodies, 1986-'93 Mustang throttle bodies, and also one that will accept a 4" diameter inlet hose for super-charger or turbocharger applications.

Pt. No.	Description
70212	Complete Snorkle Assembly - Polished
70213	Complete Snorkel Assembly - Satin
70214	LS1 Adapter - Polished
70215	LS1 Adapter - Satin
70216	4" Inlet Adapter - Polished
70217	4" Inlet Adapter - Satin
70218	1986-'93 Mustang Adapter - Polished
70219	1986-'93 Mustang Adapter - Satin
70240	Replacement O-Ring

Base of unit bolts to either square bore or spread bore carb flange.

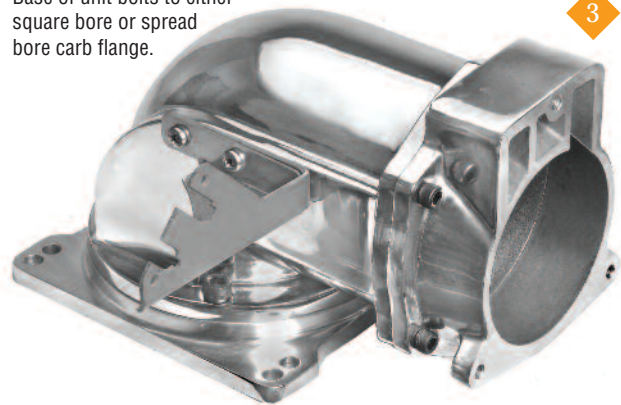

Shown with optional LS1 Adapter attached and also shown with optional #52200 stainless linkage bracket attached.

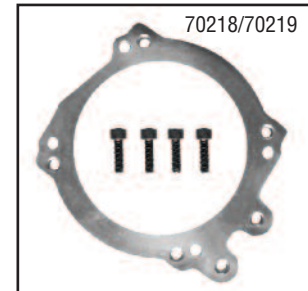
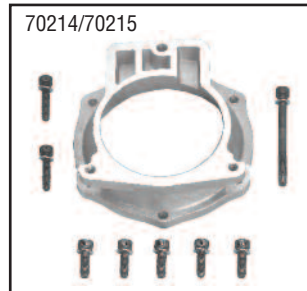
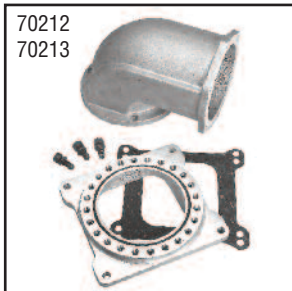

POWERFLOW™ Fuel Rail Kits for Acura GSR and Type R

The Pro/Products Fuel Rail Kits for Acuras are available in several finishes. These rails are CNC machined from billet aluminum and feature large 13.2MM (.520") bore for maximum fuel flow. They have two 1/8-NPT tapped ports for a fuel pressure gauge and/or fuel pressure regulator mounting. These Fuel Rail Kits will fit the stock mounting location and are set up to accept the stock fuel lines. The Kits fit the following Acura models: 1994-'01 Acura Integra GSR and LS, 1997-'01 Acura Integra Type R and GS, and 1995-'98 Acura Integra Special Edition.

Pt. No.	Description
10620	Blue Anodized Fuel Rail Kit for Acura
10621	Red Anodized Fuel Rail Kit for Acura
10622	Black Anodized Fuel Rail Kit for Acura
10623	Show Polished Fuel Rail Kit for Acura

POWERFILTER™ Lifetime Oil Filters

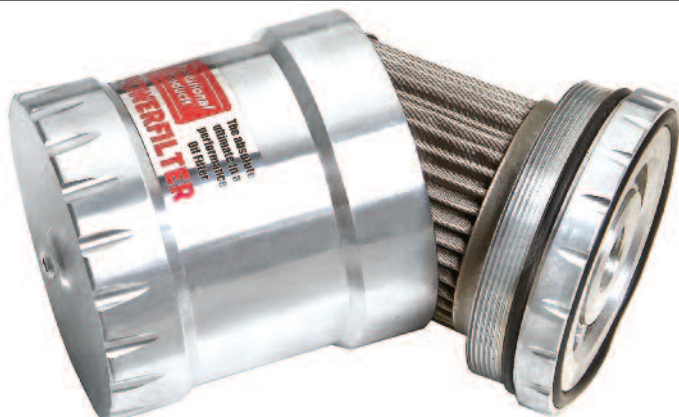

**Always wash your filter element with soap and water.
Do not use gasoline or any type of solvent.**

This outstanding line of Powerfilter Oil Filters consists of billet style precision machined products made of aircraft quality aluminum. The filter element itself is a finely woven 45 micron stainless steel mesh that is easily removed and can be washed clean and reused. That's why we call it a lifetime filter. However, we do offer inexpensive replacement elements in case your original one becomes damaged or otherwise in need of replacement. We also offer replacement o-ring kits as well. Additionally, extra fine elements are available for racing applications. Due to the extreme fine mesh used (10 microns) these filters should not be used on the street and when used in racing applications should be cleaned after each race event. These filters also feature a pipe plug in the bottom so that oil can be drained from the filter before removal. This eliminates the problem of having oil run down your arm when removing the filter housing. This page lists the most popular performance engine applications.

The Professional Products Powerfilter Oil Filter System

The Powerflow Oil Filter lineup consists of four basic filter canister sizes with different threaded bushings to make up our current twelve different filters. Note that if you change vehicles and both vehicles use the same basic canister size but with different threads, you can just switch the threaded bushings to use the filter on your new vehicle. Here is the current lineup of filters:

Filter Part No.	Filter Canister Size	Bushing Thread	Bushing Part Number	Replacement Element Std.	Replacement Element - Extra Fine
10867	Small Domestic	13/16-16 UN	10840	10815	10816
10868	Small Domestic	M18 x 1.5	10842	10815	10816
10870	Small Domestic	M20 x 1.5	10846	10815	10816
10873	Small Domestic	3/4-16 UNF	10843	10815	10816
10874	Medium Domestic	1-16 UN	No bushing required	10810	10811
10875	Medium Domestic	13/16-16 UN	10840	10810	10811
10876	Medium Domestic	M18 x 1.5	10842	10810	10811
10879	Medium Domestic	M22 x 1.5	10847	10810	10811
10881	Medium Domestic	3/4-16 UNF	10843	10810	10811
10884	Large Domestic	13/16-16 UN	10845	10812	10814

- 10950 O-Ring Kit (Import)
- 10951 O-Ring Kit (Small/Medium)
- 10952 O-Ring Kit (Large)

Overall dimensions of various sizes of filters:
 Medium Domestic - 3.25" diameter x 4.2" long
 Small Domestic - 3.25" diameter x 3.6" long
 Large Domestic - 3.90" diameter x 4.4" long

Popular Early Powerfilter Oil Filter Applications

Since many performance engines are based on earlier years, the application chart below covers most of the popular pre-1985 engines that are used in performance applications.

Chevrolet and similar GMC models	1969-'91 351W.....10881	1965-'67 425.....10875
1968-'70 396 BB Chevrolet V8.....10884	1970-'74 351C.....10881	1968-'76 455.....10875
1968-'69 427 BB Chevrolet V8.....10884	1971-'78 400.....10881	
1970-'76 454 BB Chevrolet V8.....10884	1963-'65 260.....10881	Pontiac
1967 283 & 350 SB Chevrolet V8.....10884	1963-'69 289.....10881	1961-'79 326.....10875
1976-'93 305 SB Chevrolet V8.....10884	1968-'95 302/5.0L.....10881	1961-'79 350.....10875
1968-'69 327 SB Chevrolet V8.....10884		1961-'79 389.....10875
1968-'97 350 SB Chevrolet V8.....10884	Chrysler, Plymouth, Dodge	1962 & later 421.....10875
1970-'76 400 SB Chevrolet V8.....10884	1968-'71 383.....10881	1967 & later 428.....10875
	1972-'78 400.....10881	1961-'79 455.....10875
	1968-'78 440.....10881	
Ford, Lincoln, Mercury	1975-'81 318.....10881	
1958-'66 352.....10881	1971-'80 360.....10881	
1961-'71 390.....10881		
1962-'63 406.....10881	Oldsmobile	
1963-'69 427.....10881	1967-'68 330.....10875	
1966-'70 428.....10881	1968-'80 350.....10875	
1968-'73 429.....10881	1965-'75 400.....10875	
1972-'78 460.....10881	1977-'79 403.....10875	

Note: Our filters fit a wide array of engines. What you see here is a limited listing for mostly pre-1985 engines. For more complete info for any 1985 or later vehicle, see full application chart on our website.

- 10875 interchanges with Fram HP2 or HP5**
- 10881 interchanges with Fram HP1**
- 10884 interchanges with Fram HP4**

Harley-Davidson Applications: The #10873 Powerfilter fits all Evolution or Twin Cam engines with rigid motor mounts. Fits all Sportsters. Fits all early model H-D engines with threaded oil filters. Will not fit Dyna or Touring models with rubber mounted twin cam engines.

Powerflow™ Fuel System Components

POWERFLOW™ Universal In-Tank Fuel Pump Module 3

The Universal In-Tank Fuel Pump Module is an inexpensive way to convert your older vehicle to a modern in-tank fuel pump for an aftermarket EFI systems. In-tank pumps are widely considered the best fuel delivery system compared to frame mounted inline fuel pumps. The in-tank pump runs cooler and is quieter and also lasts

longer than external inline pumps. Most aftermarket EFI systems are available in a base kit without fuel delivery components and the Powerflow Module is the ideal addition to your EFI kit. The Professional Products In-Tank Module will work on most metal gas tanks with a depth from 7-inches to 13-inches.

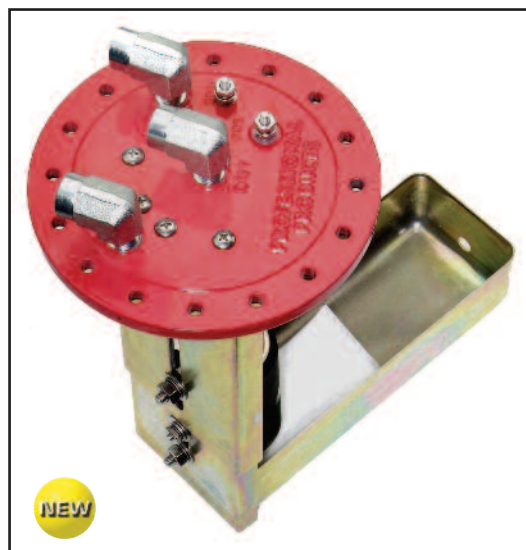
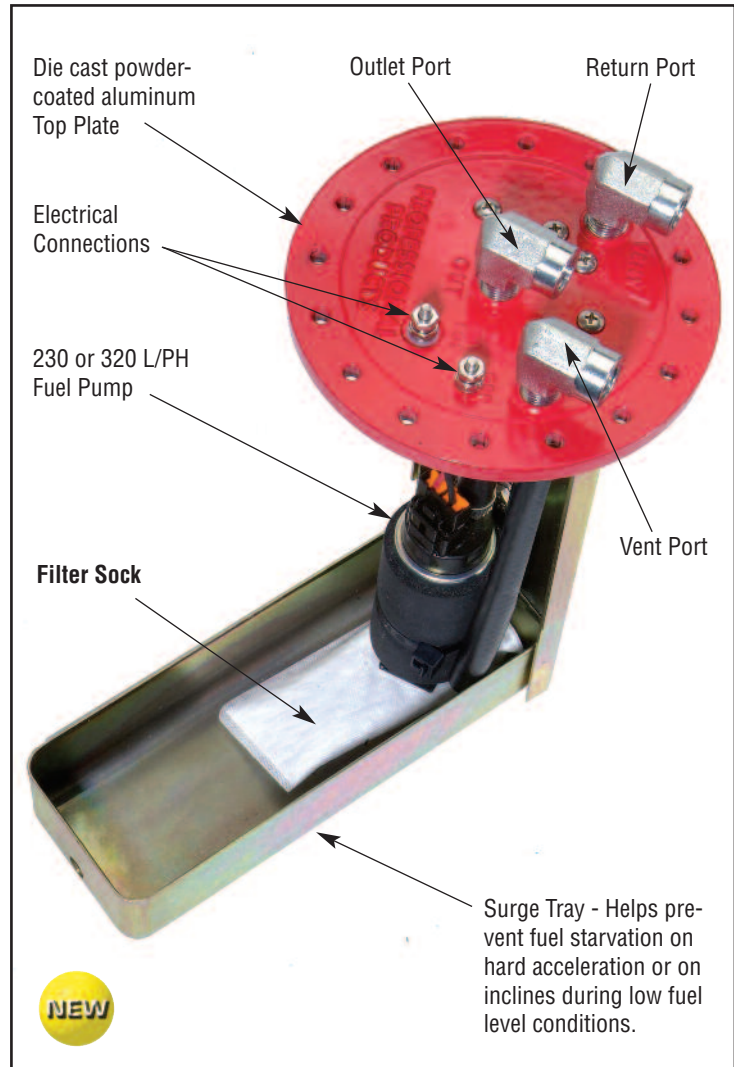
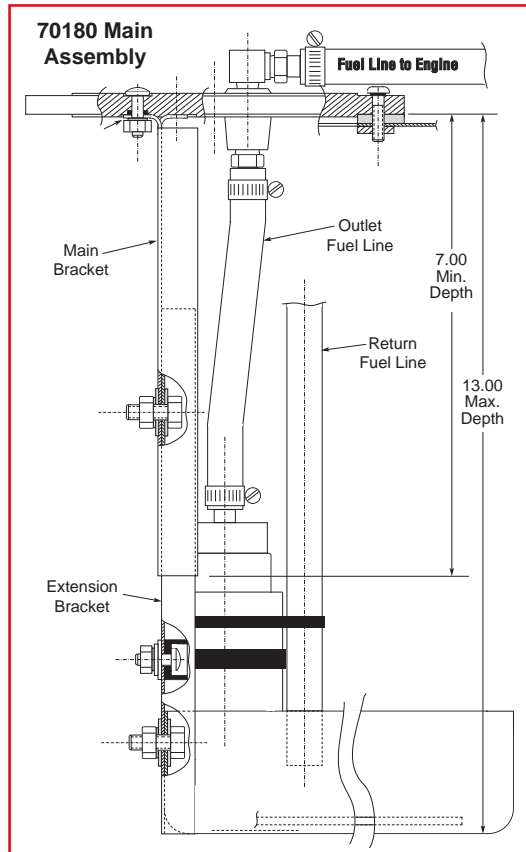

Pt. No.	Description
70180	Universal In-Tank Module - 230 L/PH
70182	Universal In-Tank Module - 300 L/PH

Under ideal conditions these pumps will service the following horsepower rated engines: The 70180 is good for up to 600 HP unblown, 490 blown. The 70182 is good for up to 800 HP unblown, 640 HP blown. Variations in input voltage, regulated fuel pressure and other factors can affect the listed ratings for horsepower.

Factors to Consider When Choosing a Powerflow™ In-Tank Pump

1. Clearance required above top of tank is 1-3/4-inches
2. Ideally you need a flat space on the top of the tank that will accommodate the 5-7/8" diameter Top Plate. If you tank has ribs, they can be flattened to accommodate the Top Plate. Location must be clear of any tank baffles.
3. Pump Module should be positioned in tank so that the Surge Tray points off to right side of vehicle with Outlet and Return Port facing forward.
3. You will need to cut a 4-1/2" diameter hole in the top of the tank. This can be accomplished with a hole saw or tin snips.
4. Tank will have to be removed from the vehicle for this installation.
5. If you are running a returnless system, the Return Port is plugged with a 1/4-NPT pipe plug. If system is otherwise vented, Vent Port can be plugged.
6. All of the hardware supplied in this kit is stainless steel to avoid corrosion from being permanently submerged in gasoline. It is the ethanol that is used in gasoline that can cause corrosion.
7. The fuel hose used as part of this assembly is high pressure, high grade hose designed for use with gasoline or alcohol.
8. Not shown in these photos is specially formulated thick cork gasket that is used between the Top Plate and the fuel tank.

POWER™ Throttle Bodies

Professional Products line of throttle bodies are generally considered by the performance industry as the highest quality throttle body available. These throttle bodies are precision engineered and many of them are made of aluminum die castings which is the same process used by the original equipment manufacturers. Those

that are not die cast are made from permanent mold castings, a superior casting process to the sand casting used by all other after-market throttle body manufacturers making cast throttle bodies. Additionally, not only is the Professional Products Power line of throttle bodies the best quality, they are also the least expensive.

Polish	Satin	Ford Application Descriptions	
69200	69203	65MM Throttle Body for 1986-'93 Mustang 5.0L V8	1
69201	69204	70MM Throttle Body for 1986-'93 Mustang 5.0L V8	
69202	69205	75MM Throttle Body for 1986-'93 Mustang 5.0L V8	
69210	69213	65MM Throttle Body for 1994-'95 Mustang 5.0L V8	
69211	69214	70MM Throttle Body for 1994-'95 Mustang 5.0L V8	
69212	69215	75MM Throttle Body for 1994-'95 Mustang 5.0L V8	
69220	69222	70MM Throttle Body for 1996-'04 Mustang 4.6L 2V V8	
69221	69223	75MM Throttle Body for 1996-'04 Mustand 4.6L 2V V8	
69224	69225	75MM Throttle Body for 1997-'04 4.6L & 5.4L Ford F-Series and Expedition & 1990-'95 4.6L 2V V8	
69232	69233	75MM Throttle Body for 1989-'93 Ford V6 Thunderbird Super Coupe and Mercury Cougar XR7	
69500	69503	65MM EGR Plate for 1986-'93 Mustang 5.0L V8	
69501	69504	70MM EGR Plate for 1986-'93 Mustang 5.0L V8	
69502	69505	75MM EGR Plate for 1986-'93 Mustang 5.0L V8	
69209		Throttle Position Sensor for 1986-'93 Mustang 5.0L V8	
<i>All part numbers above this point are assigned CARB E.O. #D-624 and are street legal in the state of CA.</i>			
69226	69227	62MM Twin Throttle Body for 2005-'10 4.6L V8 Ford	2
69228	69229	70MM Single Throttle Body for 2005-'10 V6 Ford	

Polish	Satin	Acura Application Descriptions	
69604	69605	68MM Throttle Body for 1994-'01 Acura GSR	2
69606	69607	68MM Throttle Body for 1997-'01 Acura Type R	

Polish	Satin	General Motors Application Descriptions	
69700	69701	52MM Throttle Body for 1992-'97 LT1 (TPI only, will not fit TBI)	2
69702	69703	58MM Throttle Body for 1992-'97 LT1 (TPI only, will not fit TBI)	
69704	69705	52MM Throttle Body for 1985-'92 305/350 (TPI only, will not fit TBI)	
69706	69707	58MM Throttle Body for 1985-'92 305/350 (TPI only, will not fit TBI)	
69724	69725	80MM Throttle Body for 1998-'03 LS1/LS6 Camaro & Firebird, 2004 GTO and full size 4.8, 5.3, & 6.0 engines with cable style throttle linkage.	
69726	69727	85MM Throttle Body for 1998-'03 LS1/LS6 Camaro & Firebird, 2004 GTO and full size 4.8, 5.3, & 6.0 engines with cable style throttle linkage.	
69728	69729	96MM Throttle Body for LS2 where cable throttle linkage is used.	
69732	69733	101MM Throttle Body for LS2 where cable throttle linkage is used.	
71201		Throttle Position Sensor for LS2 Throttle Bodies	

See page 26 of this catalog for replacement gaskets for all throttle bodies.

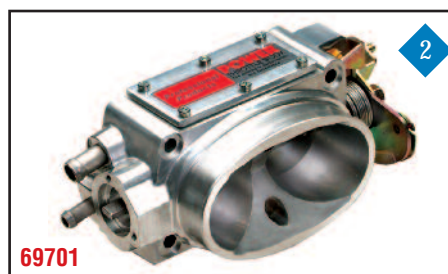
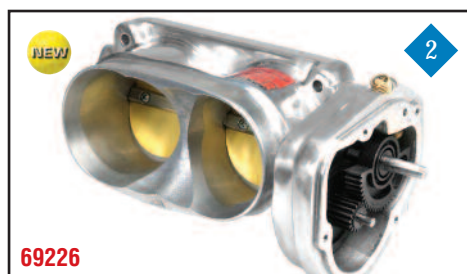
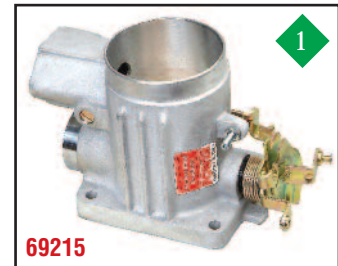

Our Basic Fuel Rail Kits typically contain the fuel rails, mounting brackets and hardware, and in some cases some fittings and other components. Note that we use stainless steel for all hardware and all mounting brackets in these kits instead of regular steel as found in most competitive kits. The Complete Kits include all the

components shown in the photos. All photos are Complete Kits. Also note that while the photos show a specific arrangement of crossover hoses and fuel regulators, in most cases the crossover hose can go at either end and the regulator can be mounted at any of the four ends of the rails or remote mounted on the firewall.

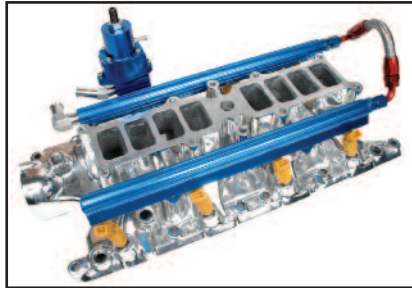

1986-'93 5.0L Ford Mustang

The 10600 kit will also fit a 1994-'95 Mustang if a smaller diameter (than stock) distributor is used. The 10601 will not fit the 1994-'95 Mustang due to interference between the regulator and the required throttle body elbow adapter. Both kits will work with O.E. and aftermarket manifolds.

- 10600** Basic Fuel Rail Kit
10601 Complete Fuel Rail Kit

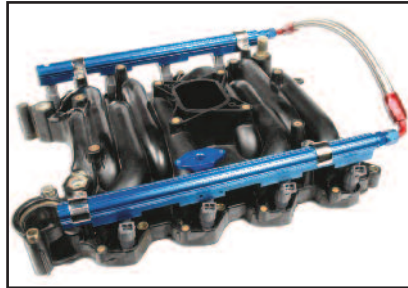

1996-'04 Ford 4.6L 2V

The early Complete Kits are supplied with a fuel pressure regulator. The late Basic and Complete Kits are supplied with an adapter mounted on the fuel rail to accept the stock fuel pressure sensor for returnless system.

- 10602** Basic Kit for 1999-'04 4.6L 2V
10603 Complete Kit for 1999-'04 4.6L 2V
10604 Basic Kit for 1996-'98 4.6L 2V
10605 Complete Kit for 1996-'98 4.6L 2V



289-302-351 Ford

These kits are designed to work with the EFI manifolds supplied by Professional Products for these engines. Use manifolds 54038/54039 for the 289/302/5.0L engines and use the 54034/54035 manifolds for the 351W. The kits include stainless steel brackets and hardware. Complete Kit includes regulator and crossover hose.

- 10606** Basic Kit for Small Block Ford
10607 Complete Kit for Small Block Ford

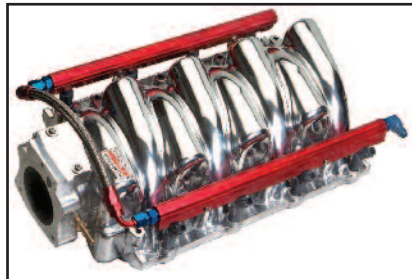

Fuel Rail Kits - LS1/LS6/LS2

These are very complete kits and even include s/s fittings and a hose extension (not shown) for connecting the stock fuel lines to the fuel inlet.

- 10610** Basic Kit for 1997-'04 LS1/LS6
10611 Complete Kit for 1997-'98 LS1
10612 Complete Kit for 1999-'04 LS1/LS6
10613 Basic Kit for 2005-'07 LS2
10614 Complete Kit for 2005-'07 LS2

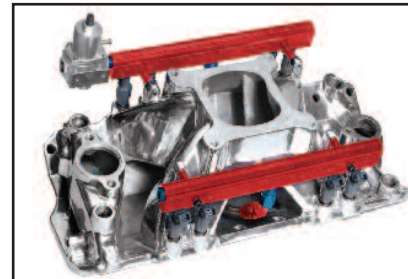

Fuel Rail Kit for SB Chevy

This kit is designed to work with the Professional Products EFI manifolds 52038/52039 and includes a regulator and a stainless braided crossover hose that goes under the center of the plenum chamber. This is the same kit we supply in our Powerjection II EFI port injection systems.

- 10608** Complete Fuel Rail Kit for SB Chevy

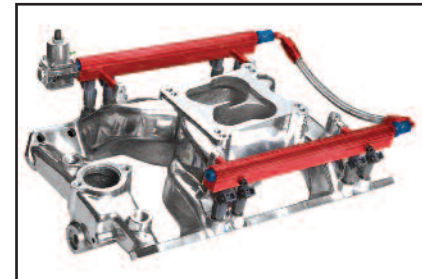

Fuel Rail Kit for Pontiac

This fuel rail kit is compatible with our dual plane Pontiac manifolds for EFI. The manifolds are 56027/56028. The kit comes with an EFI fuel pressure regulator and a -06AN stainless braided crossover hose assembly. Professional Products also offers a Pontiac EFI setup using a single plane manifold.

- 10618** Pontiac Fuel Rail Kit (Dual Plane)

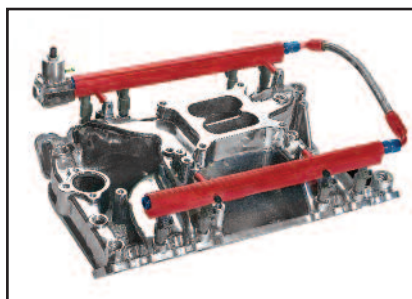

Fuel Rail Kit for Oldsmobile

Use this kit with the Professional Products EFI manifolds 57027 or 57028. This is a dual plane manifold but we have seen excellent results with it used in an EFI application. This complete kit includes a fuel pressure regulator and crossover hose and all necessary AN adapter fittings.

- 10619** Fuel Rail Kit for Oldsmobile

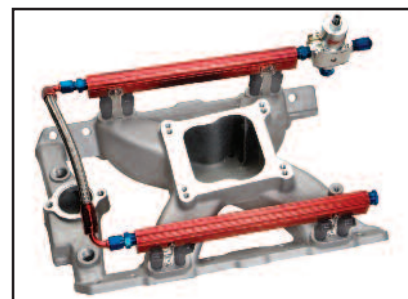

Fuel Rail Kit for Pontiac

This fuel rail kit is designed to be used with our single plane Hurricane manifold for Pontiacs, 56032 or 56033. This is an outstanding performance manifold. The manifold comes with an adapter plate to accept the square bore carb flange on throttle bodies.

- 10625** Pontiac Fuel Rail Kit (Single Plane)

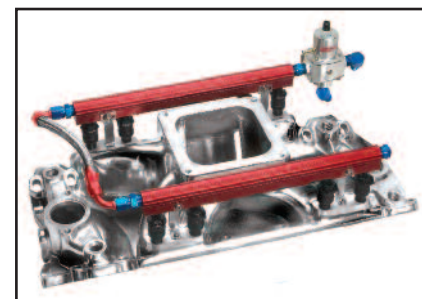

Fuel Rail Kit - Big Block Chevy

Use this kit with our 53032 or 53033 manifold. Note that this manifold has a Dominator (4500) flange on it which will accept our Dominator sized throttle bodies or we also offer an adapter that permits the use of the standard 4150 base throttle bodies. See Engine Accessories for adapter.

- 10626** Fuel Rail Kit for Big Block Chevy

POWERFLOW™ Fuel Pressure Regulators for Carburetors



3
2-Port

**(1) 1/2-NPT Inlet Port
(2) 3/8-NPT Outlet Ports
Flows 150 GPH
4.5 to 9 PSI Adjustability
.437 (7/16") Restriction**

This is an ideal all around regulator. Suitable for one dual inlet carb or two single inlet carbs. Suitable for up to 650 HP. For higher HP use two regulators

- 10650 2-Port Regulator - Blue Anodize
- 10651 2-Port Regulator - Clear Anodize



3
4-Port

**(1) 1/2-NPT Inlet Port
(4) 3/8-NPT Outlet Ports
Flows 150 GPH
4.5 to 9 PSI Adjustability
.437 (7/16") Restriction**

Suitable for two dual inlet carbs on engines up to 1,200 HP. Note that HP rating relates to number of carb inlets. This is a terrific buy for a four port unit.

- 10656 4-Port Regulator - Blue Anodize
- 10657 4-Port Regulator - Clear Anodize

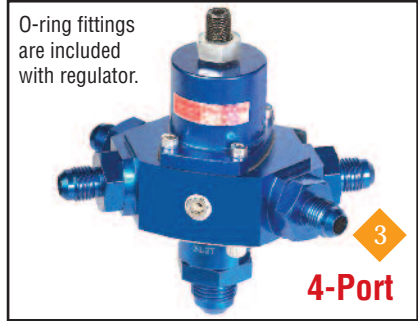

O-ring fittings are included with regulator.

3
4-Port

**(1) -08AN Inlet Port
(4) -06AN Outlet Ports
Flows 150 GPH
4.5 to 9 PSI Adjustability
.437 (7/16") Restriction**

Suitable for two dual inlet carbs on engines up to 1,200 HP. Note that HP rating relates to number of carb inlets. O-ring fittings are included with unit.

- 10654 4-Port Regulator - Blue Anodize
- 10655 4-Port Regulator - Clear Anodize

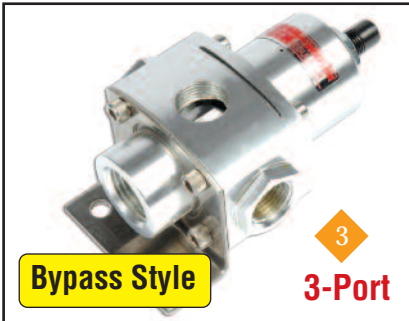

Bypass Style

3
3-Port

**(1) 3/8-NPT Return Port
(3) 3/8-NPT In/Out Ports
Flows 150 GPH
4.5 to 9 PSI Adjustability
.437 (7/16") Restriction**

Same use as the 2-port but has a return port. For converting an EFI vehicle to a carb still using the EFI high pressure fuel pump and return line.

- 10652 3-Port Regulator - Blue Anodize
- 10653 3-Port Regulator - Clear Anodize

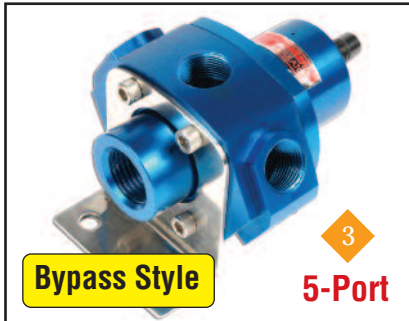

Bypass Style

3
5-Port

**(1) 3/8-NPT Return Port
(4) 3/8-NPT In/Out Ports
Flows 150 GPH
4.5 to 9 PSI Adjustability
.437 (7/16") Restriction**

Same use as 4-port unit but also has a return port. For converting an EFI vehicle to a carb still using the high pressure EFI fuel pump and return line.

- 10658 5-Port Regulator - Blue Anodize
- 10659 5-Port Regulator - Clear Anodize

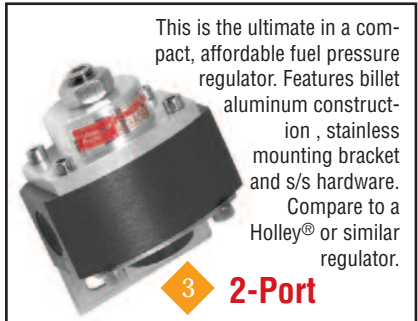

This is the ultimate in a compact, affordable fuel pressure regulator. Features billet aluminum construction, stainless mounting bracket and s/s hardware. Compare to a Holley® or similar regulator.

3
2-Port

Suitable for engines up to 450 HP. Use two units for higher HP engines with dual carburetors.

- 10660 4.5 to 9 PSI - Blue Anodize - 3/8-NPT Ports
- 10661 4.5 to 9 PSI - Clear Anodize - 3/8-NPT Ports
- 10662 2 to 4 PSI - Blue Anodize - 3/8-NPT Ports
- 10663 2 to 4 PSI - Clear Anodize - 3/8-NPT Ports
- 10665 4.5 to 9 PSI - Black and clear Anodize with 9/16-18 ports

POWERFLOW™ Fuel Pressure Regulators for Fuel Injection

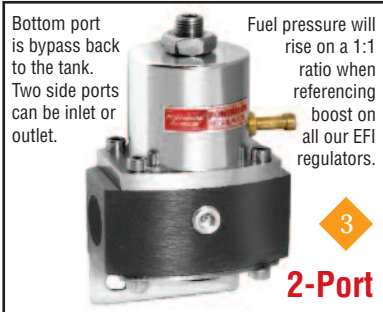

Bottom port is bypass back to the tank. Two side ports can be inlet or outlet.

Fuel pressure will rise on a 1:1 ratio when referencing boost on all our EFI regulators.

3
2-Port

Use on regular EFI systems with one feed line to the fuel rails and one return line to the gas tank. Wrench flats on 10686 makes it easy to install fittings. Adjustable from 25 to 75 PSI. Flows 200+ GPH. Stainless mounting bracket and screws are standard.

- 10685 2-Port Regulator - Black and clear aluminum. With 9/16-18 ports.
- 10686 2-Port Regulator - Black and clear aluminum. With 3/8-NPT ports.
The 10686 regulator replaces the 10670 and 10671 fuel regulators.



EFI Ford Mustang & F-150 Regulators

10678/10679
3-Bolt Mounting

10680/10681
2-Bolt Mounting

These regulators bolt directly to the factory fuel rails in place of the stock units and provide adjustability from approximately 25 PSI to 75 PSI. Very easy to install. Stainless hardware and o-ring seals.

- 10678 Fits 1986-'93 5.0L Ford & F-Series - Blue
- 10679 Fits 1986-'93 5.0L Ford & F-Series - Clear
- 10680* Fits 1994-'95 5.0L Mustang & Cobra, 1996-'97 2V and 1996-'98 4V 4.6L Mustang & Cobra, and 1994-'98 3.8L Mustang - Blue
- 10681* Fits 1994-'95 5.0L Mustang & Cobra, 1996-'97 2V and 1996-'98 4V 4.6L Mustang & Cobra, and 1994-'98 3.8L Mustang - Clear

*Also fits 1994-'95 Ford F-Series Trucks

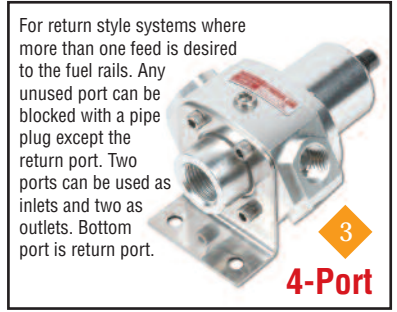

For return style systems where more than one feed is desired to the fuel rails. Any unused port can be blocked with a pipe plug except the return port. Two ports can be used as inlets and two as outlets. Bottom port is return port.

3
4-Port

**(1) 1/2-NPT Return Port
(4) 3/8-NPT In/Out Ports
Flows 200+ GPH
25 to 75 PSI Adjustability
.437 (7/16") Restriction
1/8-NPT Gauge Port
Stainless Bracket/Screws**

These regulators, as with all our units, come with stainless mounting brackets and all stainless hardware. EFI regulators feature a boost reference fitting and a 1/8-NPT gauge port.

- 10672 4-Port Regulator - Blue Anodize
- 10673 4-Port Regulator - Clear Anodize

Fuel pressure will rise on a 1:1 ratio when referencing boost on all our EFI regulators that are shown in this bottom section of the page.

POWERFLOW Fuel Pressure Regulators

Professional Products POWERFLOW™ Fuel Regulator Lineup:

Part No.	Description	Bypass	Pressure Range
10650	2-Port - (1) 1/2-NPT inlet, (2) 3/8-NPT outlets (Blue)	No	4.5 to 9 PSI
10651	2-Port - (1) 1/2-NPT inlet, (2) 3/8-NPT outlets (Aluminum)	No	4.5 to 9 PSI
10652	3-Port - (1) 3/8-NPT inlet, (3) 3/8-NPT outlets* (Blue)	Yes	4.5 to 9 PSI
10653	3-Port - (1) 3/8-NPT inlet, (3) 3/8-NPT outlets* (Aluminum)	Yes	4.5 to 9 PSI
10654	4-Port - (1) -8AN inlet, (4) -6AN outlets (Blue)	No	4.5 to 9 PSI
10655	4-Port - (1) -8AN inlet, (4) -6AN outlets (Aluminum)	No	4.5 to 9 PSI
10656	4-Port - (1) 1/2-NPT inlet, (4) 3/8-NPT outlets (Blue)	No	4.5 to 9 PSI
10657	4-Port - (1) 1/2-NPT inlet, (4) 3/8-NPT outlets (Aluminum)	No	4.5 to 9 PSI
10658	5-Port - (1) 3/8-NPT inlet, (5) 3/8-NPT outlets* (Blue)	Yes	4.5 to 9 PSI
10659	5-Port - (1) 3/8-NPT inlet, (5) 3/8-NPT outlets* (Aluminum)	Yes	4.5 to 9 PSI
10660	2-Port - (1) 3/8-NPT inlet, (2) 3/8-NPT outlets (Blue)	No	4.5 to 9 PSI
10661	2-Port - (1) 3/8-NPT inlet, (2) 3/8-NPT outlets (Aluminum)	No	4.5 to 9 PSI
10662	2-Port - (1) 3/8-NPT inlet, (2) 3/8-NPT outlets (Blue)	No	2 to 4 PSI
10663	2-Port - (1) 3/8-NPT inlet, (2) 3/8-NPT outlets (Aluminum)	No	2 to 4 PSI
10665	2-Port - (1) 9/16-18 inlet, (2) 9/16-18 outlets (Black & Alum.)	Yes	4.5 to 9 PSI
10685	2-Port - (1) 9/16-18 inlet, (2) 9/16-18 outlets* (Black & Alum.)	Yes	25 to 75 PSI
10671	2-Port - (1) 9/16-18 inlet, (2) 9/16-18 outlets* (Black & alum.)	Yes	25 to 75 PSI
10672	4-Port - (1) 3/8-NPT inlet, (4) 3/8-NPT outlets* (Blue)	Yes	25 to 75 PSI
10673	4-Port - (1) 3/8-NPT inlet, (4) 3/8-NPT outlets* (Aluminum)	Yes	25 to 75 PSI
10678	1986-'93 Ford 5.0L (Blue)	Yes	25 to 75 PSI
10679	1986-'93 Ford 5.0L (Aluminum)	Yes	25 to 75 PSI
10680**	1994-'95 Ford 5.0L and 1996-'97 4.6L (Blue)	Yes	25 to 75 PSI
10681**	1994-'95 Ford 5.0L and 1996-'97 4.6L (Aluminum)	Yes	25 to 75 PSI

*One outlet is a bypass (return) line. **See previous page for complete application data.

Carbureted Models

EFI Models

Fuel Pressure Settings

Note: For carbs set the regulator from 5 to 5.5 psi. Note that the higher you set the pressure, the more you are restricting the flow of fuel through the regulator. Injected applications typically run in the 40 to 50 psi range which is dependent upon your specific engine requirements. Here high pressure is desirable for proper injector function.

Ports

In all of our designations, when we say "2-port" or "4-port" that means the total number of outlet ports, including a return or bypass line port if the regulator is so equipped. For example, our 5-port models have one inlet port and five outlet ports, one of which is a return or bypass line port. So there are still four usable outlet ports.

Special Features

Professional Products POWERFLOW Fuel Pressure Regulators are packed with features, yet remain some of the least expensive regulators available. These regulators are a great combination of function, looks and price. We think it is an unbeatable package.

- CNC Machined from billet aluminum
- Stainless steel mounting bracket & hardware
- Wrench flats on inlet and outlet ports
- Viton O-rings and diaphragm are impervious to gas or alcohol
- All regulators have a 1/8-NPT gauge port
- Carb models pre-set to 6 psi
- EFI models preset to 40 psi
- Each unit fully tested at the factory
- EFI units include a boost reference hose barb for vacuum hose

Regulator Selection Guide:

- 2-Port (Carbs) w/o return - For one carb with a dual inlet or two carbs with single inlets.
 - 4-Port (Carbs) w/o return - For engines with two dual inlet carbs or four single inlet carbs.
 - 3-Port (Carbs) w/return - Same as 2-port above but in vehicle using EFI fuel pump w/return line.¹
 - 5-Port (Carbs) w/return - Same as 4-port above but in vehicle using EFI fuel pump w/return line.¹
 - 2-Port (EFI) - Use this in EFI systems where only one outlet to fuel rails is required. W/return port.
 - 4-Port (EFI) - Use in EFI systems where up to three outlets to fuel rails are required. W/return port.
- Ford Mustang Regulators are replacement for stock regulators but provide adjustability.

¹ If the vehicle was originally equipped with an EFI pump and return line and you are now switching to a carburetor, you need a regulator to drop the pressure to the 4.5 to 9 PSI range for carburetors. That also allows you to hook up the stock return line. Note that many 1997 and later vehicles utilize a "returnless" system. The fuel pump is in the gas tank and there is no regulator. If you are installing a carburetor on one of these vehicles, you should consider removing the pump, or disabling it, and use an external fuel pump suitable for carburetors and one of our conventional carburetor style regulators such as the 10650/10651/10656/10657/10660/10661.

Sample Carburetor/Regulator Plumbing Configurations

Two 4-bbl's with 4-Port Regulator

A 5-Port Regulator can be used with this combination but requires a return line to the fuel tank. This can be advantageous in keeping the fuel cooler by recirculating it via a return line.

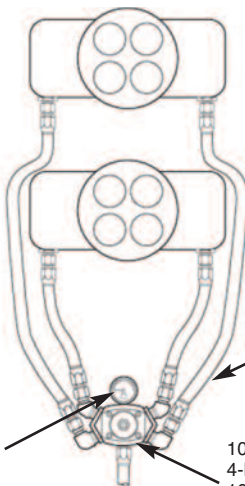

#11112
0-15 PSI Fuel Pressure Gauge

-08 Fuel Inlet Line

10656/10657
4-Port Regulator or
10658/10659
5-Port Regulator
(Bypass)

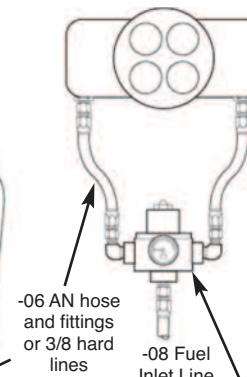

-06 AN hose and fittings or 3/8 hard lines

-08 Fuel Inlet Line

One 4-bbl with 2-Port Regulator

A 3-Port Regulator can be used with this combination but requires a return line to the fuel tank. This can be advantageous in keeping the fuel cooler by recirculating it via a return line, especially when using a high volume electric fuel pump.

10650/10651
2-Port Regulator or
10652/10653
3-Port Regulator
(Bypass)



Regulator Rebuild Kits

Our regulator rebuild kits include a Viton diaphragm, springs, seals and o-rings.

10690 - For regulators 10650, 10651, 10654, 10655, 10656, & 10657

10691 - For regulators 10652, 10653, 10658, 10659, 10670, 10671, 10672, 10673, 10678, 10679, 10680, & 10681

10692 - For regulators 10660, 10661, 10662, & 10663



O-Ring Fittings

These are the same fittings supplied with our 10654 and 10655 Regulators. These fittings can be used anywhere there is a 5/8-18 tapped hole for the -6 AN fitting or a female 3/4-16 tapped hole for the -8 AN fitting. The O-rings are impervious to gasoline or alcohol. Blue anodized finish on aluminum.

10250 - 6 AN to 5/8-18
10251 - 8 AN to 3/4-16

POWERFLOW™ Fuel Filters for Street & Race Performance

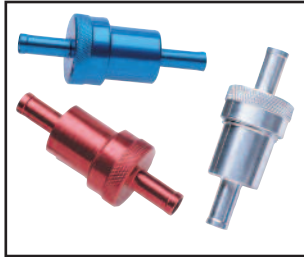

Inline Street Filters

These filters can easily be installed in any stock hose or metal fuel line. Contains a washable sintered bronze filtering element that should be replaced over time. Filters available in three colors and two hose sizes.

Color	5/16"	3/8"
Blue	10200	10203
Red	10201	10204
Aluminum	10202	10205
Element	10220	

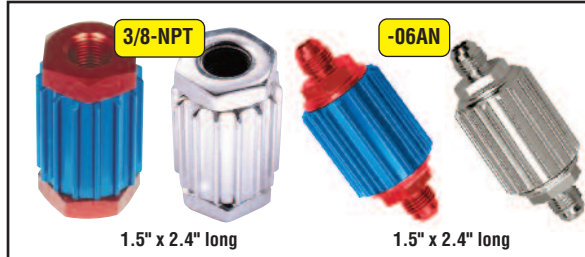

Inline Street Filters

These filters are high performance street filters that are very affordable. Both inlet and outlet ports are 3/8-NPT which permits connection to a wide range of hose sizes. These filters will flow up to 160 GPH and will filter down to 35 microns using a very fine mesh stainless screen. Due to their light weight, a mounting bracket is not required. These filters are suitable for use as a pre-filter on fuel injection applications.

10210	Red/Blue Inline Filter
10211	Aluminum Inline Filter
10216	Red/Blue Inline Filter w/-06AN
10217	Aluminum Inline Filter w/-06AN
10221	Replacement Element Kit

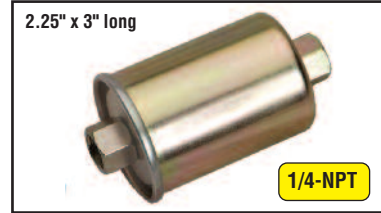

Inline EFI Filters

This filter is designed specifically for EFI applications and features 1/4-NPT ports. Similar to a Purolator F33144 except for inlet and outlet ports. For -06AN connections use our Powerflow fitting #15239, for -08AN use #15242, or for 3/8" hose connection, use our fitting #10244. This filter is intended as a "post" filter which is placed between the pump and the engine. Use any of the 10210 through 10217 filters at left as a pre-filter.

70160 EFI Inline Fuel Filter

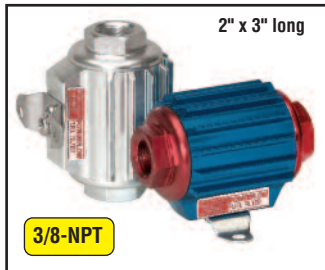

Hi-Tech Inline Street Filters

The ultimate in a performance street filter, these also include a stainless mounting bracket. They have two staged stainless mesh screens inside. They flow 150 GPH and filter down to 35 microns. This is an excellent fuel filter that looks terrific on any street rod or tricked out street machine or custom car. Mount on inner fender panel or firewall.

10214	Red/Blue Inline Filter
10215	Aluminum Inline Filter
10222	Replacement Element Kit



Competition Fuel Filter

This filter uses a replaceable paper element which filters down to 10 microns but still flows 144 GPH. This our best selling filter and features a high quality chrome finish on the housing and mounting bracket.

10100	Competition Fuel Filter
10120	Replacement Filter Element



Street Rod Fuel Filter

This is a smaller version of our 10100 canister style filter. It also uses a replaceable paper element, flows 144 GPH and filters down to 10 microns. High quality chrome finish on housing and bracket.

10102	Street Rod Fuel Filter
10122	Replacement Element

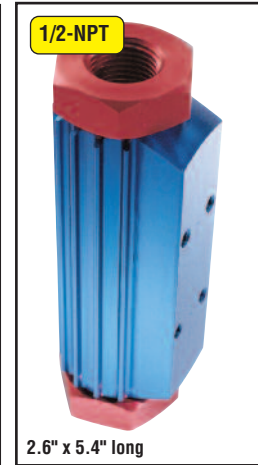

Competition Inline Fuel Filter

Designed for racing applications with gas or alcohol on a carbureted engine. Flows 140 GPH and filters to 15 microns.

10302	Red/Blue Filter
10321	Element only

Fittings for Fuel Filters



These fittings are sold in pairs and are intended for use with the fuel filters shown on this page.

Pt. No.	Description
10230	3/8-NPT to 1/4" Hose Nipple
10231	3/8-NPT to 5/16" Hose Nipple
10232	3/8-NPT to 3/8" Hose Nipple
10233	3/8-NPT to -06AN
10234	3/8-NPT to -08AN
10240	1/2-NPT to -06AN
10241	1/2-NPT to -08AN
10242	1/2-NPT to -10AN
10243	1/2-NPT to -12AN
10244	1/4-NPT to 3/8 Barbed Hose Nipple*

*For EFI use. Use with Professional Products 70160 Filter or 70150, 70151, 70152 EFI Fuel Pumps. Sold individually.

All Replacement Element Kits on this page include new Viton (or equivalent) O-rings, gaskets or seals, depending upon what was originally used in the Filter. Viton is impervious to most fuels and is the highest quality sealing material typically used. Kits also contain a new filtering element.

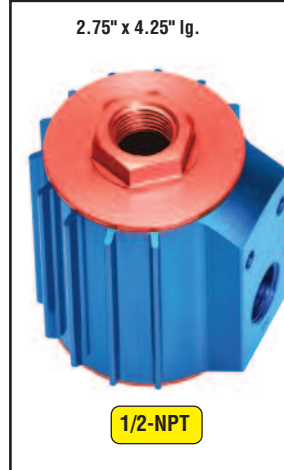

Competition+Plus Filter

These filters are the finest racing style filters available. They flow 130 GPH at 7PSI or 330 at 40PSI and filter down to 10 microns with a replaceable paper filter. Viton o-rings are used throughout and new o-rings are included with element. Two tapped holes are provided for a mounting bracket. Since most installations will require a custom bracket, one is not supplied with the filter. Note that a Barry Grant element for the BG500 Filter will fit in this filter and the 10320 element will fit the BG500.

10300	Red/Blue Filter
10320	Replacement Element

POWERFLOW™ Carburetor Inlet Kits & Fuel Pumps

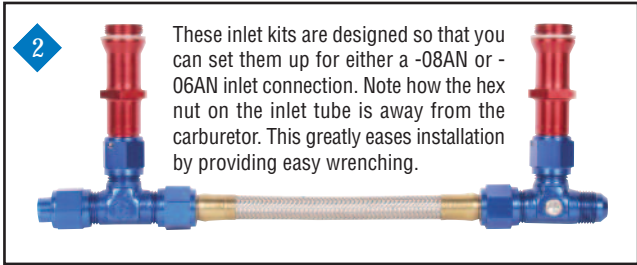

2 These inlet kits are designed so that you can set them up for either a -08AN or -06AN inlet connection. Note how the hex nut on the inlet tube is away from the carburetor. This greatly eases installation by providing easy wrenching.

- #10401 - Holley 4500 with 7/8-20 threads -08AN inlet • Red/Blue Finish
 - #10403 - Holley 4160 (3310) with 5/8-18 threads -06AN & -08AN inlet • Red/Blue
 - #10415 - Holley 4150 with 7/8-20 threads -06AN & -08AN inlet • Red/Blue
 - #10416 - Demon with 9/16-24 threads -06AN & -08AN Inlet • Red/Blue
- #10415 replaces both 10400 and 10405 and is a universal kit with -06 & -08 inlets.
 #10416 replaces both 10402 & 10408 and is a universal kit with -06 & -08 inlets.

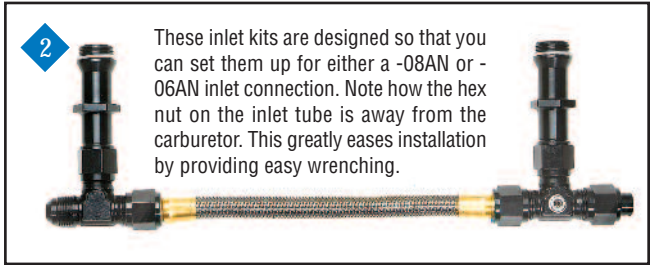

2 These inlet kits are designed so that you can set them up for either a -08AN or -06AN inlet connection. Note how the hex nut on the inlet tube is away from the carburetor. This greatly eases installation by providing easy wrenching.

- #10406 - Holley 4150 with 7/8-20 threads -06AN & -08AN inlet • Black
- #10409 - Demon with 9/16-24 threads -06AN & -08AN Inlet • Black
- #10417 - Holley 4150 with 7/8-20 threads -08AN inlet only • Black

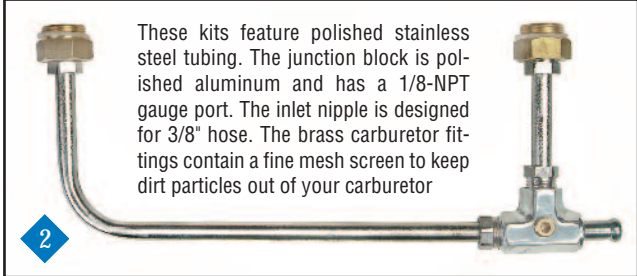

2 These kits feature polished stainless steel tubing. The junction block is polished aluminum and has a 1/8-NPT gauge port. The inlet nipple is designed for 3/8" hose. The brass carburetor fittings contain a fine mesh screen to keep dirt particles out of your carburetor

- #10420 - Demon with 9/16-24 threads - 9-9/16" spacing
- #10421 - Holley 4150 with 7/8-20 threads - 9-13/32" spacing

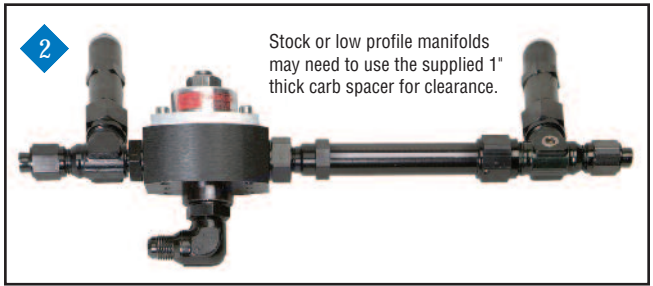

2 Stock or low profile manifolds may need to use the supplied 1" thick carb spacer for clearance.

This new Inlet Kit incorporates one of our Fuel Pressure Regulators (10665) into the overall design. This vastly simplifies the plumbing and eliminates the need for a remote mounting of the regulator. All of the threads in this kit are 9/16-18 with o-ring seals. This allows for finite adjustment of all components and also permits a simple replacement of the regulator if needed. Inlet fitting on bottom of regulator easily swivels for either a front or rear routed fuel line connection. Regulator can also be repositioned to right side of assembly.

- #10430 - Holley 4150 with 7/8-20 threads -06AN inlet • Black anodized finish
- #10431 - Demon with 9/16-24 threads -06AN inlet • Black anodized finish

Adapter

See illustration below for how to utilize this adapter fitting with above Inlet Kits.



10450 Adapter Fitting

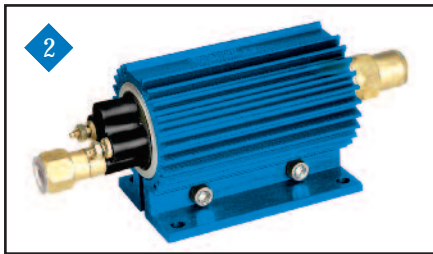
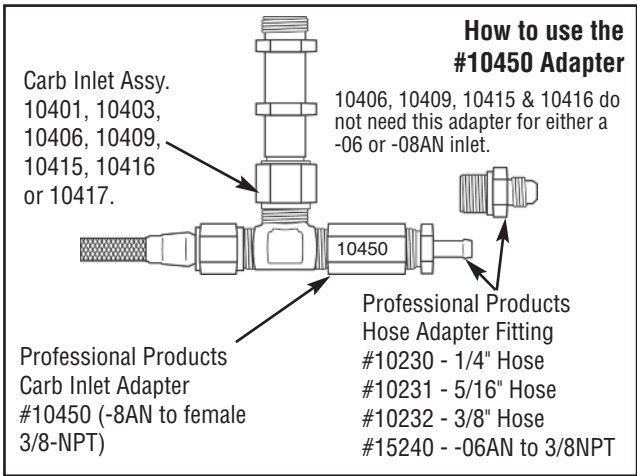

Powerflow™ EFI Fuel Pump

Available in four sizes. Three pumps come with an attractive extruded mounting bracket that also functions as a heat sink and noise suppressor.

These pumps utilize a 1/4-NPT inlet and outlet port which provides for a wide variety of readily available fittings. You can run a hose nipple connection on the inlet side of the pump. Use the Professional Products fitting #10244 designed specifically for this purpose.

- 70150 180 L/H 45 PSI EFI Fuel Pump (Red) Up to 460 HP*
 - 70151 220 L/H 45 PSI EFI Fuel Pump (Blue) Up to 600 HP*
 - 70152 255 L/H 45 PSI EFI Fuel Pump (Black) Up to 700 HP*
 - 70154 230 L/H 45 PSI EFI Fuel Pump Up to 650 HJP* (W/O bracket)
- *Reduce HP ratings by 5% for supercharged or turbocharged applications and reduce by 30% if running E85.

Electronic Fuel Pump

Professional Products offers two very inexpensive electronic fuel pumps. These pumps are ideal for replacing the stock pump when it dies. Easily installed, this pump comes in two versions. One has a working pressure of 4 to 7 PSI which is suitable for most domestic carbureted vehicles. The other is 2.5 to 4 PSI which is typically used on carbureted import vehicles. Check your vehicles requirements to select the correct pump. The 10700 is rated at 35 GPH and the 10701 is rated at 28 GPH.

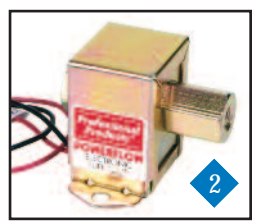

- 10700 Electronic Fuel Pump - 4 to 7 PSI
- 10701 Electronic Fuel Pump - 2.5 to 4 PSI



Carburetor Extension

Making up your own carburetor inlet kit? Use these handy Extension Fittings on either Holley or Demon carburetors. Has wrench flats away from carburetor for ease of installation. Coupler nut is -08AN.

- | Pt. No. | Description |
|---------|---------------------------------|
| 10410 | Fits Holley w/7/8-20 • Red/Blue |
| 10412 | Fits Demon w/9/16-24 • Red/Blue |

Harmonic Dampers

High Performance Street models and SFI-Spec Race Dampers

#8-32 stainless steel machine screws for plate retention on Powerforce+Plus models

All Professional Products externally balanced dampers feature bolt-in counterweights except 80001 and 90001. This provides a high degree of flexibility. For example, if you have a SB Chevy 400 damper and want to put it on a 350, simply unbolt the counterweight. You can also switch a Ford from a 28 oz. in. counterweight to a 50 oz. in. counterweight just as easily. Our counterweights are held to ± 2 grams, the most accurate in the industry.

Accurate crank bore for proper press fit onto stock crankshaft.

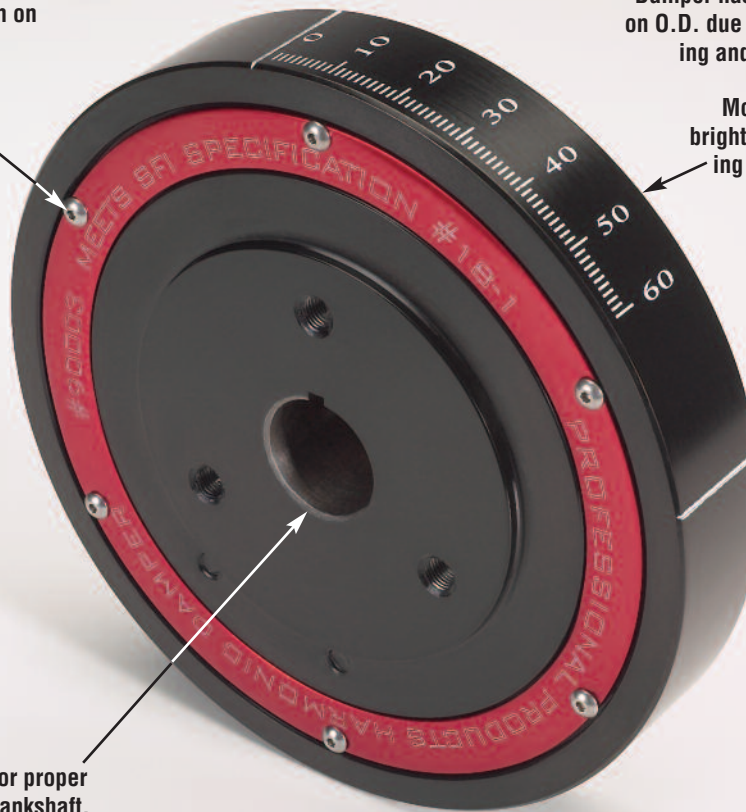

Damper has less than .005" runout on O.D. due to high quality machining and assembly procedures.

Most dampers have 60° of bright white easy to read timing marks. SB Ford models have 40° of marks.

All dampers feature tough high temperature elastomer for heavy duty applications including racing without breakdown.

Most models feature engraved timing marks every 90°.

Both hub and inertia ring made of extremely strong 1045 steel forgings on SFI-spec dampers and nodular iron on street dampers.

Look at this list of features and competitive advantages with Professional Products Dampers

Price: Yes you can buy a less expensive damper but not at this quality level. We have tested a number of lesser priced dampers. In most instances they are not accurately balanced and in every case that we tested, the external balance was not only off, it was in the wrong position.

Applications: We have yet to find a competitive company that offers the wide range of applications that we have. We have dampers for nearly every performance engine currently available.

Universality: We are able to fit more applications with fewer part numbers than any other damper manufacturer. As a result of some of our universal features, we fit engines that no one else does.

Features: The Professional Products line of dampers offers features not found with any other damper manufacturer. For example, our small block Ford dampers are made to the early short length. This permits the engine swap of 1982 and later 5.0L engines (with the 50 in. oz. damper) into early Mustangs or street rods where the longer late damper might not fit. We offer a line of inexpensive

spacers that allow the use of a wide range of pulleys that permit proper belt alignment. Additionally our SB Ford dampers have both three and four bolt pulley patterns to accept either early or late pulleys. They also have three sets of easy to read timing marks which will align with any of the various timing pointer locations that Ford has used. Our small block and big block Chrysler plus our AMC dampers all come with extra counterweights which allows the same damper to fit a wide variety of different model engines. Some of our Chrysler weights allow fitment to limited production engines that other damper manufacturers have chosen to completely ignore.

Quality: Despite our extremely attractive prices, the quality of our dampers is equal to or, in most cases, exceeds that of any other harmonic damper manufacturer. You won't find any damper that is more accurately balanced or more closely machined than what you will find in the line of Powerforce and Powerforce+Plus dampers.

RPM Limits

We recommend that the Powerforce Street Dampers be limited to 6,500 RPM and the



Powerforce+Plus Race Dampers be limited to a maximum of 9,500 RPM. Powerforce and Powerforce+Plus dampers are not recommended for sprint car or marine applications.

Easy to Read Timing Marks: Our dampers all feature clear, white, easy to read timing marks against a painted black background. In addition, most models have engraved marks every 90° which many engine builders find to be a very important feature.

Warranty: Unlike many of the competitive dampers, we have a full one year limited warranty on both our street and race dampers. Most companies do not warranty any product used in racing.

Bonded Construction: All of our dampers feature a bonding process which adheres the elastomer to both the O.D. of the hub and the I.D. of the inertia ring. Through subsequent research and development we have perfected a new process that uses a stronger adhesive along with an improved elastomer that creates a much stronger bond. It now takes twice the force to separate the hub from the ring as it did with our previous bonding procedure. Our current design is practically indestructible.

Powerforce™ & Powerforce+Plus™ Harmonic Dampers

Application	Int/Ext	Powerforce	Wgt.	Powerforce+Plus ¹	Wgt.
6" 350 SB Chevy Lightweight	Int	80010 ²	5.08	90010	5.7
6-3/4" 283/327/350 SB Chevy	Int	80000	8.46	90000	9.3
6-3/4" 400 SB Chevy	Ext	80001	7.59	90001	8.4
8" 350 SB Chevy	Int	80002	11.77	90002	12.2
8" 400 SB Chevy	Ext	80003	12.59	90003	12.9
8" 396/427 BB Chevy	Int	80004	13.51	90004	14.5
8" 454/502 BB Chevy	Ext	80005	14.56	90005	15.5
6.4" Early SB Ford (28.4 oz. in.) ³	Ext	80006 ³	9.52	90006 ³	10.25
6.4" Late SB Ford (50 oz. in.) Requires 81007 spacer ³	Ext	80007 ³	10.06	90007 ³	11.0
6.7" 429-460 BB Ford	Int	80008	8.8	90008	9.6
7.5" 352/390/406/427/428 BB FE Ford	Int	80009	11.87	90009	12.3
6.8" 4.6L Ford Modular V8 Through 2004	Int	80011	6.10	90011	7.1
7.3" 318/340/360 SB Chrysler ⁴	Int/Ext	80012 ⁴	8.12	90012 ⁴	9.0
7.3" Chrysler 383/400/413/426/440 ^{4,5}	Int/Ext	80013 ^{4,5}	8.00	90013 ^{4,5}	8.7
6.8" 5.7L Chrysler Hemi 2005-'08 Passenger Car	Ext	80014	6.8	90014	7.2
7.4" 6.1L Chrysler Hemi 2005-'10 Passenger Car	Ext	80015	7.0	90015	7.3
6.9" 1995-'08 Viper V-10	Ext	N/A	N/A	90017	6.8
6.9" 1961-'79 Pontiac V8	Int	80020	8.25	90020	10.0
6.5" 350/400/403/425/455 Olds V8 ⁷	Ext	80022	9.50	90022	10.0
7.5" LT1 (Camaro, Firebird, Impala, & Caprice ⁸)	Int	80030	12.3	90030	13.7
7.8" LS3 (Except Corvette)	Int	80031 	13.55	90031 	13.5
7.5" LS1 Camaro, Firebird	Int	80032	13.6	90032	14.4
7.5" LS1, LS-6 Corvette	Int	80033	11.2	90033	13.2
7.7" L92 GM Truck & SUV	Int	80034	13.8	90034	13.9
7.6" Lightweight BB Chevy 396/427	Int	80036	9.35	90036	9.65
7.6" Lightweight BB Chevy 454/502	Ext	80037	10.40	90037	10.70
7.5" 4.6L 3V Ford	Int	80040	11.2	90040	11.5
7.0" 5.0L Ford Mustang Coyote	Int	N/A	N/A	90042 	12.9
6.4" Lightweight SB Ford, Early	Ext	80045	7.8	90045	8.2
6.4" Lightweight SB Ford, Late	Ext	80046	8.4	90046	8.8
5" Honda/Acura (Honda B-16, Acura GSR & Type R)	Int	N/A	N/A	90050	3.2
6" Honda B-16	Int	80051	6.6	N/A	N/A
5.6" Acura GSR 1994-'01 Integra	Int	80052	5.4	N/A	N/A
5.4" Acura Type R 1997-'01 Integra	Int	80053	5.6	N/A	N/A
6.9" L-Series Nissan 1970-'83	Int	80055	3.8	90055	4.0
7.2" 4.0L Jeep	Int	80100	7.1	N/A	N/A
6.8" AMC V8 (304, 360, & 401 cid) ⁴	Ext	80101	10.6	90101	11.7
0.35" thick Spacer for SB Ford	N/A	81006	0.2	81006	0.2
0.95" thick Spacer for SB Ford		81007	0.53	81007	0.53
0.875" thick Spacer for SB Ford		81008	0.5	81008	0.5
Spacer for 426 Hemi (Use w/80013 or 90013)		81013	0.56	81013	0.56
C'weight for 6.75" SB Chevy 400		91001	1.05	91001	1.05
C'weight for SB Chevy 400		91003	0.7	91003	0.7
C'weight for BB Chevy 454/502		91005	0.95	91005	0.95
C'weight for early SB Ford (28.4 oz. in.)		91006	1.2	91006	1.2
C'weight for late SB Ford (50 oz. in.)		91007	1.8	91007	1.8
Ford Damper Pilot Adapter		91011	0.03	91011	0.03
C'weight for '71-'92 360 SB Chrysler		91012	1.15	91012	1.15
C'weight for '93-'97 360 SB Chrysler		91013	0.67	91013	0.67
C'weight for '72-'73 340 SB Chrysler		91014	0.23	91014	0.23
C'weight for BB Chrysler ⁶		91015 ⁶	0.69	91015 ⁶	0.69
C'weight for BB Chrysler ⁶		91016 ⁶	0.29	91016 ⁶	0.29
C'weight for Olds V8		91022	1.12	91022	1.12
C'weight for 360 AMC V8		91101	1.06	91101	1.06
C'weight for 304 AMC V8		91102	0.89	91102	0.89
C'weight for 401 AMC V8	N/A	91103	1.52	91103	1.52

General Note: All dampers listed as Ext include all necessary counterweights. Counterweights also sold separately.

Note 1. All the dampers in this column meet SFI-Spec 18-1.

Note 2. This damper is 1045 steel. All other 80000 series dampers are nodular iron. All 90000 series dampers are 1045 steel.

Note 3. See page 43 for information on spacers that may be needed. 1969 and later engines will normally require a spacer for pulleys to line up. See additional note on page 38.

Note 4. Chrysler dampers come with several different counterweights to suit various engines. Weights given in chart do not include

counterweights.

Note 5. Will also fit street and race 426 Hemi. Must use spacer #81013. These dampers will not fit early 331/354/392 Hemi engines.

Note 6. These counterweights for cast crank engines only.

Note 7. Early 330 cid engine must have TDC remarked. Early 400/425 requires rebalancing of Professional Products damper.

Note 8. This damper also fits 1993-'97 LT1 Camaro/Firebird, and 1994-'95 Chevrolet Caprice, Chevrolet Impala, and Buick Roadmaster.

Professional Products Harmonic Damper Tech Notes:

What is a neutral balance damper? An externally balanced damper? An internally balanced damper? - Some engines are designed that they cannot get enough weight on the counterweights on the crank to bring the engine into balance. Engine designers added counterweights onto the damper and the flexplate or flywheel. This type of damper is called an externally balanced damper. That's because some of the counterweight for the crank is external to the engine since it is on the damper and flywheel. Without counterweights on the damper or flywheel they are called internally balanced or neutral balanced. These two terms are interchangeable. Engine builders can convert an externally balanced engine to internally balanced by adding an extremely heavy material called mallory metal to the counterweights of the crank. When this is done, a neutral balance damper must be used on what was previously an externally balanced engine. With our bolt-in counterweights, any of our externally balanced dampers can quickly and easily be converted to neutral balance by simply removing the weight. This is a very valuable feature and provides for great flexibility in engine building.

Small block Chevy - These engines have used three different timing pointer locations. Pre '69 engines have the TDC mark 2° to the left of the keyway centerline. The '69 to '85 dampers have the TDC mark 10° to the left of the keyway centerline. The 1986 to 1991/1992 have the TDC mark 40° to the left of the keyway centerline. All of our SB Chevy dampers, as well as all other aftermarket dampers, use the 10° TDC position. Our 6.75" diameter models have two TDC marks, one that is 10° and one that is 40° to the left of the keyway. If you have a pre '69 vehicle you can use one of the aftermarket bolt-on timing pointers to align correctly with the timing marks on our dampers.

Small & Big Block Chevy - Both of these styles of engines utilize both internal and external balance dampers. All of our external dampers have bolt-in counterweights. Other than that, the dampers are identical for each style engine. So it is possible to have an internally balanced damper and convert it to external simply by adding one of our optional counterweights. Some big blocks may require an aftermarket timing pointer to align with the TDC mark on all our dampers.

Small Block Ford - Small block Ford (260/289/302/351/5.0L) dampers were made in five different lengths, two different accessory bolt patterns, and with two different external counterweights. They also had at least three different timing pointer locations. We make two models; the 80006/90006 has the 28.4 oz. in. counterweight and the 80007/90007 has the 50 oz. in. counterweight. Both of these dampers are made to the early style shortest length. This will allow users to install '82 & later 5.0L engines (w/50 oz. in. dampers) in early Mustangs or street rods and have more clearance in the front than if they had the stock longer damper. Our dampers also have both 3 and 4-bolt pulley patterns so either early or late pulleys can be used. For later applications with longer dampers, we offer a series of three inexpensive aluminum spacers (see page 43) that accommodate these various applications. Because some of the early three bolt accessory pulleys piloted on a male boss and some piloted into a female bore, we also provide (with every damper) a special pilot adapter to accommodate either style. Both our Ford small block dampers have three sets of timing marks on them to accommodate the various timing pointer locations Ford used. To the best of our knowledge, between our two dampers and three spacers, we can fit nearly every SB Ford engine ever made. Will not fit 1970-'77 Mercuriser.

How to Determine Which Ford Spacer To Use - Measure the overall length of your damper from the end of the snout to the front pulley face. If it is 3" long, no spacers are required. If it is 3.187" long, you can modify spacer #81006 to work. (See instructions that come with the damper) If it is 3.375" long, use spacer #81006. If it's 3.875" long, use spacer #81008. If it's 4.0" long, use spacer #81007. For additional information, see chart on page 43.

Pontiac V8 - Our Pontiac dampers can be used on 1961 through 1979 V8

engines. However, in order to fit 1961 through 1968 you must use a '69 or later front timing cover, water pump, and related accessories. This damper has the stock accessory pulley bolt holes as well as a big block Chevy bolt pattern. This will accommodate big block Chevy crank trigger setups.

Small Block Chrysler - We provide one damper model that can be used without a counterweight for internally balanced engines. Or use one of three supplied counterweights for other engines. The 80012 and 90012 Dampers will fit the following applications:

- All internally balanced 318 V8 standard and Magnum, all internally balanced 273 and 340 engines w/forged cranks. No counterweight is used with any of the above applications.
- 340 externally balanced 1972-'73 engines w/cast crank. Use supplied 91014 counterweight.
- 360 externally balanced 1993-'97 engines w/cast crank. Use supplied 91013 counterweight. Will not work with '93-'97 5.9L Magnum engine.
- 360 externally balanced 1971-'92 engines w/cast crank. Use supplied 91012 counterweight.

Big Block Chrysler - Our one part number (80013/90013) damper fits all 351, 361, 383, 400, 413, 426, and 440 engines including Street and Race 426 Hemi models. Will not fit early 331/354/392 Hemi. These dampers are neutral balanced and also include two counterweights to fit externally balanced models. Damper includes two extra TDC marks to suit the Street and Race models of 426 Hemi. Our 81013 Hemi Spacer is required to ensure proper pulley alignment on 426 Hemi engines. To our knowledge, this damper should fit all big block Chrysler engines.







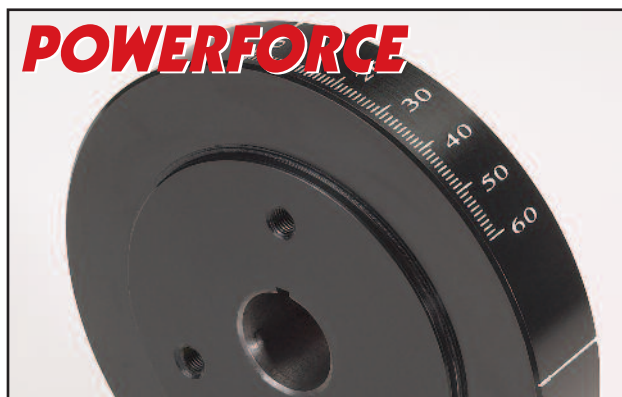



















Big Block FE Ford - Our damper is identical in fit and function to the original big block high performance 427 FE Ford damper. It is supplied with a matching bolt-on single v-groove accessory pulley which may or may not be required in all applications. This pulley can be removed and using a supplied adapter you can bolt on any multiple groove FE pulley. This damper is classed as an internally balanced damper although the 428 FE is externally balanced. On that engine all of the external weight is on the flexplate or flywheel. The damper is still a neutral balance damper and has no weight attached to it. All other FE engines (except 428) are internally balanced. Our FE Ford dampers are supplied with a universal timing pointer that will fit any FE engine. This pointer is required because our supplied damper is larger in diameter (same as 427) than some FE dampers and the stock pointer will not work on engines that came stock with the smaller diameter damper.

Big Block 429-460 Ford - This damper utilizes a separate counterweight that is a spacer that goes over the crank and behind the damper. These weights are available from your Ford dealer (#M-6359-D460) and must be used unless the engine assembly has been converted to an internally balanced engine by incorporating heavy metal in the crankshaft. These engines have used different timing pointer locations. Looking at the front, most of these engines have a timing pointer in the "10 o'clock" position. Using the 1/4" keyway in our damper correctly positions the damper on a production crank (or aftermarket crank machined to stock specs) so a "10 o'clock" pointer lines up with the damper TDC mark. Use the 3/16" keyway with Ford Racing cranks #M63030-A600 and B600 to again align a "10 o'clock" pointer to the damper's TDC mark.

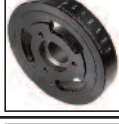

















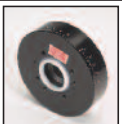



AMC - We supply a damper and two counterweights with each of our two AMC part numbers. The basic damper is neutral balance and can be used "as is" for neutral balance engines. One supplied counterweight is for the 304 engine, and one for the 360. These are all four bolt pulley style dampers. Note that AMC made a 343 and a 390 engine. These dampers used a three bolt pulley. If you have a 390 and convert to four bolt pulleys, you can use this damper. Compare your 390 damper to the instruction illustrations to determine which weight to use for your 390.

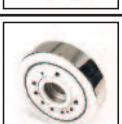
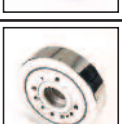







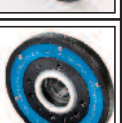



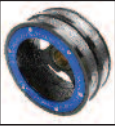









Powerforce™ & Powerforce+Plus™ Harmonic Dampers

	Damper Photos		Powerforce	Powerforce+Plus	Diameter	Description
	Powerforce	Powerforce+Plus	Part No.	Part No.		
Small Block Chevy			80000	90000	6.75"	These dampers are 6.75" in diameter and approximately 1-1/8" thick. These are our most popular dampers for internally balanced small block Chevys. They both have 60° of timing marks with engraved marks every 90°. They are dimensionally identical to a stock 6-3/4" damper.
				For 283-327-350 Internally Balanced V8 Engines		
			80001	90001	6.75"	These dampers are 6.75" in diameter and approximately 1-1/8" thick. These are believed to be the only affordable dampers available in this size for externally balanced engines such as the 383 and 400 small block Chevy. Like all our Chevy dampers they have 60° of timing marks.
				For 383-400 Externally Balanced V8 Engines		
			80002	90002	8.00"	These are our 8" dampers for internally balanced small block Chevys and are among our most popular dampers. The larger 8" dampers do a more precision job of damping out engine harmonics but will not accelerate as quickly as the smaller, lighter 6" or 6.75" dampers we offer.
				For 283-327-350 Internally Balanced V8 Engines		
			80003	90003	8.00"	The dampers listed here are identical to the 80002/90002 but include a bolt-in counterweight that provides the necessary imbalance for externally balanced engines such as the 383 or 400. This damper can be easily converted to a neutral balance damper by simply unbolting the counterweight.
				For 383-400 Externally Balanced V8 Engines		
		80010	90010	6.10"	The 80010 and 90010 are our lightest dampers and both are made of forged 1045 steel. They both have 60 degrees of timing marks and engraved marks every 90 degrees. These are two of our most popular dampers and thousands of them are in use in both street and race vehicles.	
			For 283-327-350 Internally Balanced V8 Engines			
		80030	90030	7.50"	These dampers will not fit 1996-'97 LT4 Corvette and Camaro or 1992-'96 LT1 Corvette. To identify an LT1 from an LT4 the VIN number for an LT1 has the eighth digit as a "P" and an LT4 has it as a "5." These dampers have a keyway (key supplied). Crank has a keyway but no key is used originally.	
			For GM LT1 Engines			
		82000	N/A	6.75"	Here is the answer to a custom engine builder's dream. A polished all stainless steel harmonic damper available in the popular 6.75" diameter. This damper has an engraved TDC mark but all other markings have been eliminated by design to provide a super clean look. Use timing tape if desired.	
			For 283-327-350 Internally Balanced V8 Engines			
		82001	N/A	6.75"	This is the externally balanced version of our all stainless polished damper. The damper is offered in the 6.75" diameter which is a popular size for street rod and custom car engines. These stainless dampers are the crowing touch for any small block Chevy show engine. Use timing tape if desired.	
			For 383-400 Externally Balanced V8 Engines			
Big Block Chevy			80004	90004	8.00"	This is our standard 8" damper for 396/427 (or any internally balanced big block Chevy engine) and is one of the few dampers we make that does not match the original O.E. size which was 7" on these engines. Using the 8" diameter allows interchangeability with our 454/502 dampers.
				For 396-427 Internally Balanced V8 Engines		
			80005	90005	8.00"	These dampers are the identical dampers to the 80004/90004 but are fitted with a bolt-in counterweight to provide the proper imbalance for the 454/502 externally balanced engines. Remove the counterweight and it can be used on any neutral balance (internal) big block Chevy engine.
				For 454-502 Externally Balanced V8 Engines		
			80036	90036	7.60"	These are our new smaller lightweight dampers for big block Chevys. The 80036 is over four pounds lighter than our 80004 and the 90036 is just under five pounds lighter than the 90004. These dampers are also slightly smaller in diameter being 7.6" compared to 8.0" for further weight reduction.
			For 396-427 Internally Balanced V8 Engines			
		80037	90037	7.60"	Again, these dampers are identical to the 80036/90036 but include a bolt-in counterweight to provide the proper imbalance for the externally balanced engine. The 80037 is 4.2 pounds lighter than the 80005 and the 90037 is 4.8 pounds lighter than the 90005.	
			For 454-502 Externally Balanced V8 Engines			
LSX GM			80031	90031	7.75"	This damper is new for 2016 and fits the popular LS3 style engine. Note that it will not fit the Corvette. The Corvette damper is shorter and requires totally different accessory mounting brackets than the passenger car and truck versions of this engine.
			NEW For LS3 Internally Balanced V8 Engines			

Powerforce™ & Powerforce+Plus™ Harmonic Dampers

	Damper Photos		Powerforce	Powerforce+Plus	Diameter	Description
	Powerforce	Powerforce+Plus	Part No.	Part No.		
GM LSX & L92			80032	90032	7.50"	Although not found on the stock damper, these dampers have a TDC mark and a keyway for use on engines converted to a conventional distributor and a crank with a key. These dampers are the same overall dimensions as a stock damper to avoid fitment issues.
				For 1997-'04 LS1-LS6 Camaro and Firebird		
			80033	90033	7.50"	The Corvette models of the LS1 damper are shorter than the 80032/90032 so may be more desirable for engine swaps where space is at a premium. If this swap is made, Corvette accessory mounting brackets will also need to be used to assure proper accessory drive belt alignment.
			For LS1-LS6-LS2 Corvette			
		80034	90034	7.70"	The L92 engine is the cast iron version of the LSX range of engines. This is known as the LM7 engine option and is a 5.3L engine that was available in 2001 and later Tahoe, Yukon, Yukon XL, Escalade, ESV, EXT, Avalance, Sierra, and Silverado. Also sold by GM as a crate engine.	
			L92 Truck & SUV & GM LSX Crate Engines			
Small Block Ford V8			80006	90006	6.40"	Note that all of our small block Ford dampers are made to the early 1963-'69 length and require the use of spacers (see page 43) on '70 and later engines. These dampers have three sets of timing marks (60° of marks) to fit all small blocks. They also come with both 3 and 4 bolt pulley patterns.
				For early small block Ford w/28 oz.in. c'weight		
			80007	90007	6.40"	1982 and later 5.0L applications require our spacer #91007 for proper belt alignment. Without the spacer the 5.0L engine can be used in swaps into earlier vehicles as long as early accessory pulleys, mounting brackets and belts are used. Damper has both 3 and 4 bolt pulley patterns.
				For late small block Ford w/50 oz. in. c'weight		
			80045	90045	6.40"	These are lightweight versions of our regular Ford small block dampers. These dampers are essentially the same as the 80006/90006 but lighter by approximately two pounds. The lightweight dampers still use the same counterweights used in our regular dampers.
				For early small block Ford w/28 oz. in. c'weight		
			80046	90046	6.40"	Again, this is our lightweight version for the late small block Ford. These dampers have all the same features found in our 80007/90007 dampers but are about two pounds lighter. They have three sets of timing marks to essentially match up to all small block Ford timing pointers.
				For late small block Ford w/50 oz. in. c'weight		
	Polished Stainless Steel	82006	N/A	6.40"	This damper is a true work of art and is the finishing touch to any street rod or street custom vehicle with a fully detailed engine. It is a full polished all stainless steel damper which will never rust or corrode. Dimensionally the same as the 1963-'69 damper but will fit all engines using our spacers.	
			For early small block Ford w/28 oz. in. c'weight			
	Polished Stainless Steel	82007	N/A	6.40"	Use our 91007 spacer with this damper for a bolt-in to any 1986 or later 5.0L engine. This damper is made to the early (1963-'69) short length with both 3 and 4 bolt pulley patterns so is ideal for engine swaps where the longer 5.0L damper can cause interference issues.	
			For late small block Ford w/50 oz. in. c'weight			
Big Block Ford V8			80008	90008	6.70"	These dampers feature the stock 3/16" keyway plus a 1/4" keyway 180° from the stock one. This allows the damper to fit aftermarket dual keyway crankshafts. Note that while these engines are classed as an externally balanced engine, the counterweight is a separate (Ford #M-6359-D460) part.
				For 429-460 Big Block Ford V8's		
		80009	90009	7.50"	These dampers are dimensionally the same as the 427 high performance damper. It comes with the 427 single groove pulley which can be removed and replaced with your stock multi-groove pulleys. A universal timing pointer is supplied so you can replace your 7" FE damper with this 7.5" one.	
			For all FE style Big Block Fords			
4.6L Ford V8 (2V, 3V, 4V)			80011	90011	6.80"	These dampers are dimensionally the same as the stock 2V damper. When used on a 4V engine the accessories (alternator, A/C, etc) will rotate 3% slower than the stock 4V accessories. For most applications, this is not a significant difference. These dampers have a TDC notch on the back rim.
				For 4.6L Ford V8 2V and 4V		
		80040	90040	7.60"	If you are racing your late model Mustang you need one of our 90040 dampers to meet SFI specs. Save over \$100 compared to other aftermarket dampers for this engine. Our 80040 is a great choice for your street Mustang especially if you have any modifications to the engine.	
			For 2005 & later 4.6L Ford 3V V8 Engines			

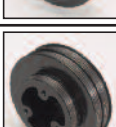
Powerforce™ & Powerforce+Plus™ Harmonic Dampers

Damper Photos		Powerforce	Powerforce+Plus	Diameter	Description
Powerforce	Powerforce+Plus	Part No.	Part No.		
5.0L Coyote	Street Damper not available for this application		N/A For 5.0L 4V Mustang Coyote V8 <small>NEW</small>	7.00"	The Mustang Coyote is one of Ford's most powerful Mustangs and the only available SFI-spec dampers available for it are extremely expensive. Now Professional Products offers an affordable SFI-spec harmonic damper for this popular applications. This damper is new for 2016.
			80012 For all small block Chrysler V8's	7.25"	These dampers come with three bolt-in counterweights which, when the proper weight is used, allow this damper to fit all small block Chrysler engines. With no weights, it is a neutral balance damper. The dampers have 60 degrees of timing marks and engraved marks every 90 degrees.
			80013 For all big block Chrysler V8's	7.25"	The big block dampers are supplied with two bolt-in counterweights which cover all big block applications. Use our spacer 81013 to fit late street or race 426 Hemi. Dampers will not fit early 331, 354, or 392 Hemis but will fit all other big block Chrysler engines. See "Damper Notes" for more specifics.
			80014 5.7L Late Dodge & Chrysler Hemi 2005-'08 Cars Only	6.80"	The new Chrysler Hemis are now finding their way into many street rods and high performance street machines and we offer one of the most affordable dampers for these engines. Our models are dimensionally identical to the stock O.E. damper to avoid any clearance or fitment issues.
			80015 6.1 Late Dodge & Chrysler Hemi 2005-'10 Cars Only	7.40"	The 6.1 Chrysler Hemi is a very popular high performance engine and needs a high performance harmonic damper to go with it. We offer some of the most affordable harmonic dampers for these engines. Our dampers are dimensionally the same as the stock damper to avoid clearance issues.
	Street Damper not available for this application		90017 90017 - 1992-'10 Dodge Viper	6.95"	The 90017 Powerforce+Plus Damper fits all Viper V-10's from 1992 through 2010. This is the least expensive SFI-Spec damper available for these engines. It features 1045 steel construction and contains retaining lips and rings to provide a safety feature.
Pontiac			80020 For 1961-'79 Pontiac V8s	6.90"	To fit these dampers to an early 1961-'68 engine will require the use of the 1969 or later timing chain cover, water pump, and related accessories. The necessary parts can be obtained from Year One. Some aftermarket Pontiac specialists also offer the late timing cover in aluminum.
			80022 For 330 through 455 Oldsmobile V8s	6.50"	These are externally balanced dampers with bolt in counterweights which can be removed for a neutral balance engine. This damper has both the stock Olds pulley bolt pattern as well as big block Chevy. TDC mark must be repositioned for 330's and damper fits only the late 400 and 425.
Jeep		Damper not available for this application	80100 For 4.0L Jeeps	N/A 7.20"	This damper fits the popular 4.0L Jeep 6-cylinder engine. It matches the stock damper dimensionally but is made of tough nodular iron. This damper is an ideal choice for off-roaders who want the ultimate in damper reliability and strength. The elastomer is securely bonded to the hub and inertia ring.
AMC V8			80101 For 304, 360 AMC V8	90101 6.80"	These dampers are set up for the later model 4-bolt accessory pulleys. The damper is supplied as a neutral balance damper with two bolt-in counterweights to suit either the 304, or 360 AMC engine. Note that these will not fit the 360 Chrysler engine used in some later model AMC's.
Honda, and Acura		Damper not available for this application	80051 Honda B-16	N/A 6.00"	This damper is a direct replacement for the stock Honda damper. The Professional Products Powerforce Harmonic Damper is made of tough nodular iron rather than gray iron, a 30% increase in strength. These dampers are now available with an engraved TDC mark.
		Damper not available for this application	80052 For Acura GSR 1994-'01 Integra	N/A 5.60"	This damper is a direct replacement for the stock Acura GSR damper. The Professional Products Powerforce Harmonic Damper is made of tough nodular iron rather than gray iron, a 30% increase in strength. These dampers are now available with an engraved TDC mark.
		Damper not available for this application	80053 For Acura Type R 1997-'01 Integra	N/A 5.40"	This damper is a direct replacement for the stock Acura Type R damper. The Professional Products Powerforce Harmonic Damper is made of tough nodular iron rather than gray iron, a 30% increase in strength. These dampers are now available with an engraved TDC mark.

Powerforce™ & Powerforce+Plus™ Harmonic Dampers

Honda & Nissan Dampers	Damper Photos		Powerforce	Powerforce+Plus	Diameter	Description
	Powerforce	Powerforce+Plus	Part No.	Part No.		
			N/A	90050	5.00"	Many Honda and Acura racers use the JDM single accessory pulley on their engines. However, that product is not a damper. Our model is a true damper and is dimensionally identical to the JDM pulley. To preserve the life of your crankshaft, a harmonic damper should be used on any race engine.
			80055	90055	5.12"	These dampers are dimensionally identical to the O.E. 1970-'78 Nissan damper. Will also fit 1979-'83 engines requiring only one v-belt pulley. This damper is similar to the popular but now discontinued "Euro" damper from the Nissan Competition Division.

New Import Dampers in Development. Coming soon: Subaru Impreza WRX/STI EJ20, EJ22, Mitsubishi Eclipse 4G63 and 4G63T, and Mitsubishi EVO 8 & 9

Tire Pressue Gauges & Other Assorted Gauges



Professional Products Fuel Pressure Gauges feature a 1/8-NPT male pipe nipple on the back, a 1-1/2" diameter face and a chrome bezel. Not liquid filled. Not for use inside the passenger compartment unless a fuel pressure isolator is installed.

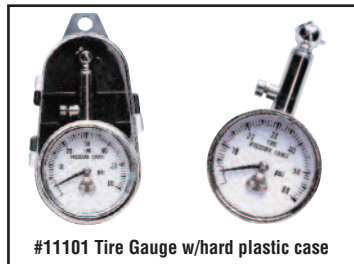

Racing Tire Pressure Gauges

- 11100 0-15 PSI Tire Gauge with 13mm hose and rubber protector
- 11103 0-60 PSI Tire Gauge with 13mm hose and rubber protector
- 11104 0-120 PSI Tire Gauge w/Braided Stainless Steel Hose
- 11105 0-120 PSI Tire Gauge w/Tread Depth Measurement Feature

Street Tire Pressure Gauges

- 11101 0-60 PSI Tire Gauge w/45° end and hard plastic case
- 11102 0-60 PSI Tire Gauge w/9" long hose and hard plastic case
- 11106 0-160 PSI Truck Tire Gauge w/rigid extension for wide truck wheels
- 11107 0-60 PSI Tire Gauge w/long rubber hose and 45° angled end
- 11110 0-100 PSI Digital Tire Gauge (reads in 1/2-lb. increments)

Fuel Pressure Gauges

- 11112 0-15 PSI Fuel Pressure Gauge for use on carbureted vehicles
- 11113 0-100 PSI Fuel Pressure Gauge for use on injected vehicles

Compression Tester

- 11108 0-300 PSI Compression Tester - Fits both 14mm and 18mm spark plug holes with dual thread fitting on hose.

Sport Ball Pressure Gauge

- 11109 0-15 PSI Pressure Gauge - For basketballs, and other sport balls

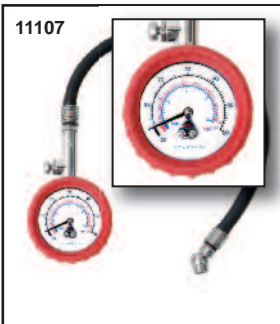

To use Tread Depth Measuring Feature on the 11105 Tire Pressure Gauge:

1. Set surface "A" on tire tread.
2. Press down on pin "B" allowing Pin "C" to go into tread.
3. Read tread depth on gauge in either 32nds of an inch or in millimeters.

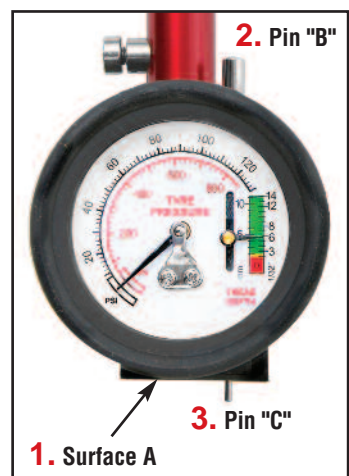

Powerforce™ & Powerforce+Plus™ Harmonic Dampers

Small Block Ford Harmonic Damper Spacer Selection Chart

Engine Type	Damper Length	Model Year	Use Spacer	3- or 4-Bolt Pulley
289/302/351W	3.050"	1963-'69	No Spacer Req'd	3-Bolt
351W/351C/400M ^{1,2}	3.400"	1969-'80	#81006 (.350")	4-Bolt
351 HO (351W) ³	3.875"	1991 & later	#81008 (.875")	4-bolt
351W/302 ³	3.875"	1980 & later	#81008 (.875")	4-bolt
302/5.0L	3.950"	1970-'96	#81007 (.950")	4-bolt
351W	3.950"	1980-'96	#81007 (.950) or #81009 Steel for blown engines.	4-bolt

NOTES:

1. Remove .070" off of rear of damper if Ford .917" Crank Sprocket is used. See drawing at right.
2. A 3.187 damper length may have been used on some the listed applications. This requires spacer modification. See modifications shown in instructions that come with the damper.
3. The 3.875" long dampers are used on engines equipped with Ford Racing .917" Crank Sprocket.

Remove .070"
See Note #1

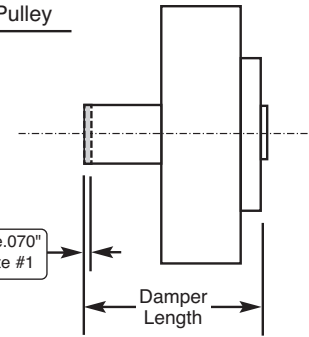

Our SB Ford Dampers are all made to the 1963-'69 length. This allows the use of both early and late style dampers in early chassis. You can use our late 5.0 damper with early three bolt pulleys and accessories. All of our SB Ford dampers also have both the three and four bolt pulley patterns. They also have three sets of timing marks to suit all SB engines. If your stock damper is longer than three inches, we make up the difference with a series

of spacers. To determine which spacer you need, measure the length of your damper (see drawing above) and refer to the chart to see which spacer you need. Our standard spacers are made of aluminum and are very inexpensive. If you have a 5.0L engine running a belt driven blower, we recommend that you use our 81009 Steel Spacer instead of the 81007 aluminum one. See photo and listing below left.

Harmonic Damper Accessories and Service Parts

Ford Pulley Spacers



81006
.350" thick

81007*
.950" thick

81008
.875" thick

*Use the 81007 spacer on all 1986 and later 5.0L engines.

About Our Bolt-In Counterweights

Bolt-in counterweights are a major plus feature in all of our externally balanced harmonic dampers. For example, if you purchased one of our externally balanced dampers and then during your engine build procedure, you decide you want to switch to a neutral balance assembly, you don't need to buy a new damper. You simply unbolt the counterweight and you are good to go. We have sold thousands and thousands of dampers with bolt-in counterweights and we have never heard of one single instance where a counterweight has come loose or fallen out. It just does not happen. So if you have concerns about this, you can forget about them.



Steel Damper Spacer for Blown 5.0L Fords

Utilize this spacer instead of the standard 81007 aluminum spacer (when using a Professional Products damper) on a 5.0L Ford engine when utilizing a belt driven supercharger.

81009 Steel Spacer



Timing Pointer for FE Ford

This universal Timing Pointer will fit all FE Ford engines. This pointer is intended to be used with the larger diameter 7.5"

dampers such as the Professional Products models or the 427 FE high performance model. When replacing a smaller diameter FE damper with our 7.5" model, this pointer will be used. This pointer is included with all of our FE dampers and fits both styles of timing covers.

92009

FE Ford Universal Timing Pointer



Hemi Spacer

Use this Spacer with our 80013 or 90013 damper in order to fit to the late style 426 Street or Race Hemi engine. This spacer will ensure proper accessory belt alignment.

81013

Hemi Spacer

