

Steinjäger

Suspensions & Accessories for Jeep® Wrangler®

MAY 2017 EDITION



CJ-7 >
1976-1986



CJ-8 >
1981-1986



YJ >
1987-1995



XJ >
1984-2001



TJ >
1997-2006



JK/JKU >
2007-Present



Made in the USA

Steinjäger uses the American flag icon to show which of our products are Made in the USA. Look for it throughout our catalog!



Steinjäger

Suspensions & Accessories



JK & JKU WRANGLER

Tube Doors	4-7	Hi-Lift Handle Holders	21
Mirrors	8-9	D-Ring Shackles & Mounts	22-23
Grab Handles	10-12	Tire Delete Plates	23
Stirrups Steps & Dead Pedals	13	Hitch Covers & Flag Poles	24-25
Interior Organizers	14-15	Cargo Covers, Nets, Teddy® Tops	26-29
Rear Storage for 2 Door JK	16	LED Brackets	30-31
Tire Carrier for 2 Door JK	17	Rock Sliders	32-35
Foot Pegs & Can Holders	18	Sway Bars & End Links	37
Limb Risers & Hood Latches	19	Track Bars & Panhard Bars	38-39
Door Handle Accents	20	Control Arms & Coil Springs	40-42
License Plate Relocation Kit	21	Lift Kits	43-45



TJ & LJ WRANGLER

Tube Doors	46-48	Tire Delete Plates & Stingers	54
Mirrors	49	Cargo Nets & Teddy Tops	55-57
Grab Handles & Foot Pegs	50-51	Sway Bars & End Links	58-59
Winch Plates & LED Brackets	52	Track, Panhard Bars, Tie Rods	60-61
Limb Risers & Hood Latches	53	Control Arms & Long Arm Kits	62-63



YJ WRANGLER

Tube Doors, Nets & Teddy®	64-67	Suspension Parts	68
---------------------------	-------	------------------	----



CHEROKEE XJ

Suspension Parts	69
------------------	----



CJ-7 & CJ-8

Doors & Foot Pegs	70
-------------------	----



Steinäger

Decals	71	Dealers	76-77
Banners and Hats	72	History, Mission & Culture	78
Shirts, Tanks, & Hoodies	73	Warranties & Trademarks	79

COLOR AND HYDROGRAPHIC OPTIONS























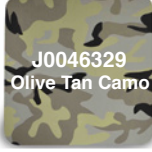

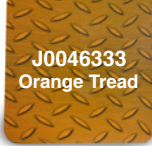
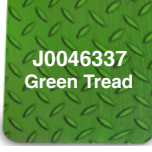

Powder Coat Options

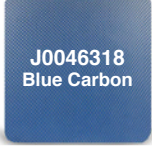

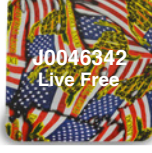
Steinjäger offers a variety of powder coated color options. Each product offering section shows the colors offered and their specific part number. These are the most popular color options:

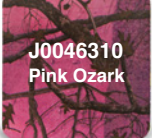
	Bare Metal		Fluorescent Orange		Sinbad Purple
	Black		Locas Green		Cloud White
	Texturized Black		Military Beige		Gray Hammetone
	Southwest Blue		Pinky		Gecko Green
	Playboy Blue		Lemon Peel		Hot Pink
	Neon Green		Red Baron		Neon Yellow

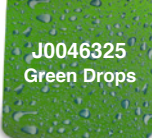
Hydrographic Options

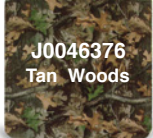

TUBULAR DOORS

USA MADE FOR JK AND JKU



 **TUBULAR DOORS FOR JK & JKU**

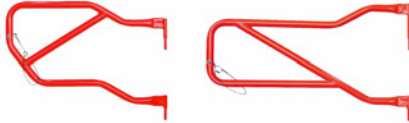

Color

-  Bare Metal
-  Black
-  Texturized Black
-  Southwest Blue
-  Playboy Blue
-  Neon Green
-  Fluorescent Orange
-  Locas Green
-  Military Beige
-  Pinky
-  Lemon Peel
-  Red Baron
-  Sinbad Purple
-  Cloud White
-  Gray Hammertone
-  Gecko Green
-  Hot Pink
-  Neon Yellow
-  Hydrographics

Front Doors

- J0041322
- J0031026
- J0041015
- J0040944
- J0040945
- J0040946
- J0040947
- J0040948
- J0040949
- J0040950
- J0040951
- J0040952
- J0042643
- J0042646
- J0041339
- J0046380
- J0046381
- J0046379
- J0046814

Rear Doors

- J0041323
- J0031027
- J0041259
- J0040954
- J0040955
- J0040956
- J0040957
- J0040958
- J0040959
- J0040960
- J0040961
- J0040962
- J0042644
- J0042647
- J0041340
- J0046383
- J0046384
- J0046382
- J0046815



TUBULAR DOORS

DOOR HOLDERS & HANGERS



FOUR DOOR HOLDER STAND

Holds Four Doors

J0042631



This unique product can be used to store factory doors or tubular doors in the field, in the showroom, or in your hotel room. Knocks down quickly for travel, but rugged enough for dealer showrooms. Powder Coated. Made in the USA.

WALL MOUNTED DOOR HANGER

Holds Two Doors Mounts to wall studs and holds factory and tubular doors.



Color

Part#

	Bare Metal	J0044960
	Black	J0030814
	Texturized Black	J0044970
	Southwest Blue	J0044963
	Playboy Blue	J0044964
	Neon Green	J0044966
	Fluorescent Orange	J0044961
	Locas Green	J0044968
	Military Beige	J0044969
	Pinky	J0044967
	Lemon Peel	J0044965
	Red Baron	J0044962
	Sinbad Purple	J0044972
	Cloud White	J0044973
	Gray Hammertone	J0044971

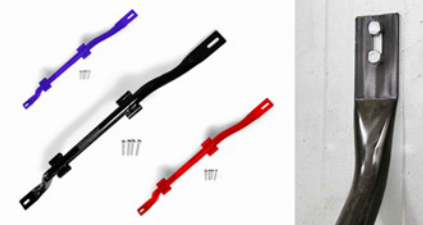

Steinjäger Latch Upgrade



These handy latch upgrades make our great tube doors even better!

Part#	# of Pins
J0043481	1
J0043482	2
J0043483	4



Steinjäger

TUBULAR DOORS

DOOR COVERS



DOOR COVERS



Made in the USA. Fits Steinjäger tube doors.

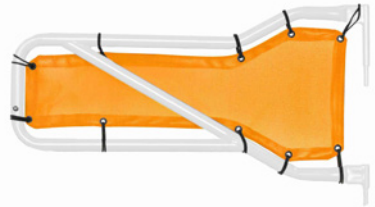

		Color	Rear#	Front#
		Black	J0041085	J0041050
		Orange	J0041355	J0041366
		White	J0041356	J0041367
		Royal Blue	J0041357	J0041368
		Gray	J0041358	J0041369
		Lemon Yellow	J0041361	J0041372
		Red	J0041362	J0041373
		Burgundy	J0043601	J0043603
		Dark Green	J0043602	J0043604
		Mauve	J0043855	J0043856



TUBULAR DOORS

DOOR NETS



DOOR NETS



Made in the USA. Fits Steinjäger tube doors.

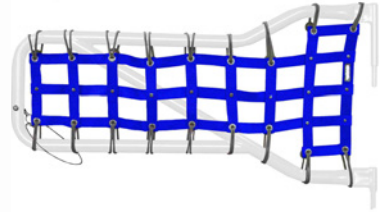
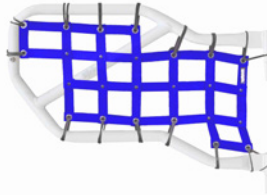

Color **Rear#**
Black J0043597

Front#
J0043596



Orange J0043661

J0043657



Gray J0043662

J0043658



Red J0043663

J0043659



Blue J0043664

J0043660

Arm Rests



Made in the USA. Fits Steinjäger tube doors.

Color **Part#**
Black J0041031



2 per kit Red J0046098



2 per kit Blue J0046104

Door Limiting Straps



Made in the USA.

For Steinjäger Tube Doors

Front Doors J0041622

Rear Doors J0041623

Bungees, 6" Long



8 pack J0043458

10 pack J0041051



Steinjäger

MIRRORS

VISIBILITY & STYLE

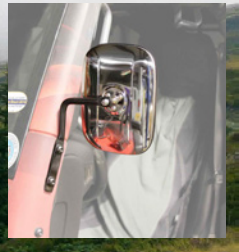

Doorless Mirror Legs Basic Design

A-Pillar Mount Mirror Legs



Mirror sold Separately

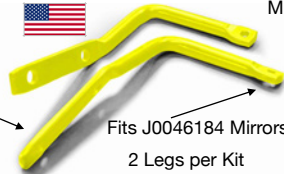
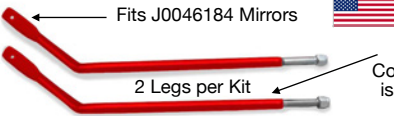

	Bare Metal	J0046296
	Black	J0046185
	Texturized Black	J0046199
	Southwest Blue	J0046198
	Playboy Blue	J0046195
	Neon Green	J0046193
	FL Orange	J0046188
	Locas Green	J0046191
	Military Beige	J0046192
	Pinky	J0046194
	Lemon Peel	J0046190
	Red Baron	J0046196
	Sinbad Purple	J0046197
	Cloud White	J0046187
	Gray Hammet'n	J0046189
	Gecko Green	J0046591
	Hot Pink	J0046592
	Neon Yellow	J0046590
	Hydrographics	J0046942

	Bare Metal	J0046715
	Black	J0046716
	Texturized Black	J0046726
	Southwest Blue	J0046719
	Playboy Blue	J0046720
	Neon Green	J0046722
	FL Orange	J0046717
	Locas Green	J0046724
	Military Beige	J0046725
	Pinky	J0046723
	Lemon Peel	J0046721
	Red Baron	J0046718
	Sinbad Purple	J0046728
	Cloud White	J0046729
	Gray Hammet'n	J0046727
	Gecko Green	J0046731
	Hot Pink	J0046732
	Neon Yellow	J0046730

Mirrors

Vent Mirrors

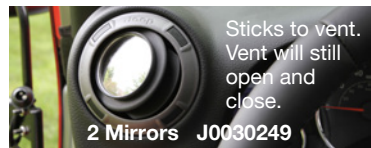

MIRRORS

VISIBILITY & STYLE



Doorless Mirrors

Isolated & Patented

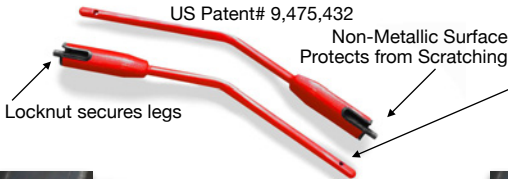

Tube Door Mirrors

fits Steinjäger Doors

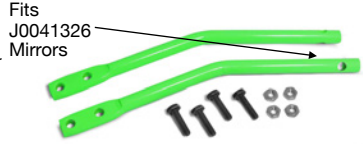

	Bare Metal	J0045998
	Black	J0045997
	Texturized Black	J0046008
	Southwest Blue	J0046001
	Playboy Blue	J0046002
	Neon Green	J0046004
	FL Orange	J0045999
	Locas Green	J0046006
	Military Beige	J0046007
	Pinky	J0046005
	Lemon Peel	J0046003
	Red Baron	J0046000
	Sinbad Purple	J0046010
	Cloud White	J0046011
	Gray Hammert'n	J0046009
	Gecko Green	J0046585
	Hot Pink	J0046586
	Neon Yellow	J0046584
	Hydrographics	J0046941

	Bare Metal	J0046295
	Black	J0040967
	Texturized Black	J0046213
	Southwest Blue	J0046212
	Playboy Blue	J0046209
	Neon Green	J0046207
	FL Orange	J0046202
	Locas Green	J0046205
	Military Beige	J0046206
	Pinky	J0046208
	Lemon Peel	J0046204
	Red Baron	J0046210
	Sinbad Purple	J0046211
	Cloud White	J0046201
	Gray Hammert'n	J0046203
	Gecko Green	J0046594
	Hot Pink	J0046595
	Neon Yellow	J0046593
	Hydrographics	J0046943

Steinjäger Mirrors
are sold separately.



2 Mirrors J0041326
Hydrographics J0046938

Magnetic Legs



Patented Design

2 Legs
J0041001

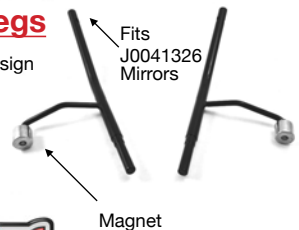

Steinjäger

GRAB HANDLES

FRONT RIGID HANDLES





















Front Rigid Grab Handles



Steinjäger Front Rigid Grab Handles are made from steel and are powder coated a variety of colors. Our handles' unique design gives you a great grab handle without interference with the Jeep's visor. Made in the USA.



	Bare Metal	J0041455
	Black	J0041052
	Texturized Black	J0041248
	Southwest Blue	J0041241
	Playboy Blue	J0041242
	Neon Green	J0041244
	Fluorescent Orange	J0041239
	Locas Green	J0041246
	Military Beige	J0041247
	Pinky	J0041245
	Lemon Peel	J0041243
	Red Baron	J0041240
	Sinbad Purple	J0043589
	Cloud White	J0043592
	Gray Hammertone	J0041351
	Gecko Green	J0046504
	Hot Pink	J0046505
	Neon Yellow	J0046503
	Hydrographics	J0046900



GRAB HANDLES

REAR RIGID HANDLES



Rear Rigid Grab Handles

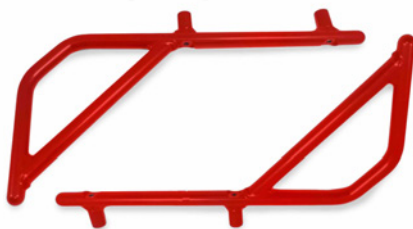

Made from steel and powder coated a variety of colors, our rear handles come in two different designs to allow for differences between the 2 door (JK) and 4 door (JKU) models. Made in the USA.



	2 Door JK	4 Door JKU
Bare Metal	J0043508	J0041454
Black	J0043494	J0040941
Texturized Black	J0043504	J0041238
Southwest Blue	J0043497	J0041231
Playboy Blue	J0043498	J0041232
Neon Green	J0043500	J0041234
Fluorescent Orange	J0043495	J0041229
Locas Green	J0043502	J0041236
Military Beige	J0043503	J0041237
Pinky	J0043501	J0041235
Lemon Peel	J0043499	J0041233
Red Baron	J0043496	J0041230
Sinbad Purple	J0043506	J0043590
Cloud White	J0043507	J0043593
Gray Hammertone	J0043505	J0041350
Gecko Green	J0046498	J0046507
Hot Pink	J0046499	J0046508
Neon Yellow	J0046497	J0046506
Hydrographics	J0046949	J0046901



HANDLES & ACCESS

GRAB HANDLES, WINCH STRAPS



Roll Bar Grab Handles

We mold and sew these handles in the USA. Designed to fit over the factory roll bar, these handles come ready for installation.

Black: 2 Handles **J0031248**

Red: 2 Handles **J0043796**



Rear Middle Grab Handles

We mold and sew these handles in the USA. Designed to utilize the factory bolts in the sound bar.



1 Handle **J0040915**

Rear Grab Handles

We mold and sew these handles in the USA. Designed to utilize the factory bolts in the outside sound bar. These can also attach to the head rest posts.



2 Handles **J0040917**

Winch Hook Straps



Black **J0043803**



Blue **J0043805**



Red **J0043807**



Orange **J0043809**



Gray **J0043811**

Our Winch Hook Straps are designed for a non-slip grip to making pulling the winch cable easier.



ACCESS

STIRRUP STEPS



Stirrup Steps

Convenience for getting into your lifted Jeep. The Stirrup fits easily under the seat when not in use.













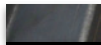





Dead Pedals

Need a comfortable place to rest your foot while driving? Use the Steinjäger Dead Pedal.

Installation is simple and allows you to keep your door limit straps.



	Bare Metal	J0045861
	Black	J0045860
	Texturized Black	J0045871
	Southwest Blue	J0045864
	Playboy Blue	J0045865
	Neon Green	J0045867
	FL Orange	J0045862
	Locas Green	J0045869
	Military Beige	J0045870
	Pinky	J0045868
	Lemon Peel	J0045866
	Red Baron	J0045863
	Sinbad Purple	J0045873
	Cloud White	J0045874
	Gray Hammer'tn	J0045872
	Gecko Green	J0046458
	Hot Pink	J0046459
	Neon Yellow	J0046457

	Bare Metal	J0046247
	Black	J0046233
	Texturized Black	J0046243
	Southwest Blue	J0046236
	Playboy Blue	J0046237
	Neon Green	J0046239
	FL Orange	J0046234
	Locas Green	J0046241
	Military Beige	J0046242
	Pinky	J0046240
	Lemon Peel	J0046238
	Red Baron	J0046235
	Sinbad Purple	J0046245
	Cloud White	J0046246
	Gray Hammer'tn	J0046244
	Gecko Green	J0046464
	Hot Pink	J0046465
	Neon Yellow	J0046463

Steinjäger

ORGANIZERS

SEAT SUPPORTS, DOG PARTITIONS



JKU

Dog Partitions



An effective way to keep your dog safely in the back seat while you drive. Mounts to roll bar and seat mounting bracket. Made in the USA.



Black **J0044980**



Orange **J004981**



Red **J0044982**



Gray **J0044983**



Blue **J0044984**



Green **J0045771**

Roll Bar Dog Leash

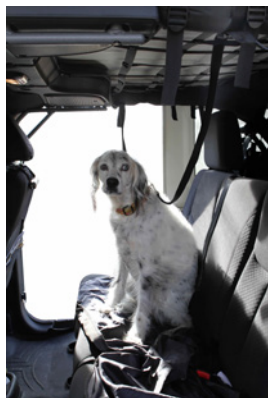

J0043588

This handy leash centers your dog between both roll bars. Only use when you are in the Jeep with your dog. Don't leave your dog unattended with this leash!

Rear Center Seat Support



J0044979



If you've even ridden in the center back seat in a Jeep 4 door JKU, you'll appreciate this device. It simply fits under the middle back seat and gives that seat the support it needs.

ORGANIZERS

COAT HOOKS & OVERHEAD ORG



Pistol Holder



J0045472

This handy device is made from stainless steel rod in the USA and hangs below the steering column.

It is your responsibility to follow all local, state and federal laws relevant to gun transport and use.

Overhead Organizers

STORE SMALL ITEMS IN POCKETS OVERHEAD



Our overhead organizer has 4 pockets. Fits any top - stock or aftermarket.

Made in the USA. Fits JK, JKU and TJ.



Coat Hook Kit

This simple metal loop and strap attaches to the rear roll bar and gives you a place to hang your jacket. Fits JK, JKU, TJ, YJ, CJ-7, CJ-8.

2 Hooks **J0045737**



J0043921
Camo

J0045849
Pink Snowfall

J0045850
Black

J0045851
Royal Blue

J0045852
Red

J0045853
Charcoal

Gun Magnet



J0030792

Poly encased magnet sticks to metal, creating a handy place to lean your unloaded shotgun.



REAR STORAGE BOX

FOR 2 DOOR JK



Rear Storage Box for 2 Door JK Wrangler

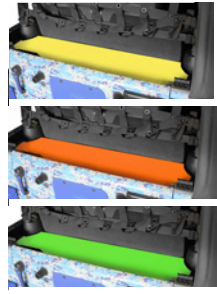

The one piece construction of our Rear Storage Box helps keep your cargo secure while in transit or unattended. Fits to existing anchor points within your Jeep. Fits 2 door models only. Made in the USA.

	Bare Metal	J0045947
	Black	J0045948
	Texturized Black	J0045958
	Southwest Blue	J0045951
	Playboy Blue	J0045952
	Neon Green	J0045954
	Fluorescent Orange	J0045949
	Locas Green	J0045956
	Military Beige	J0045957
	Pinky	J0045955
	Lemon Peel	J0045953
	Red Baron	J0045950
	Sinbad Purple	J0045960
	Cloud White	J0045961
	Gray Hammer'tn	J0045959
	Gecko Green	J0046467
	Hot Pink	J0046468
	Neon Yellow	J0046466



INTERNAL TIRE CARRIER









2 DOOR JK

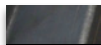

Internal Tire Carrier for 2 Door JK Wrangler

Holds 35 inch tire inside while still leaving room for tools and a cooler. Mounts to factory roll bar. Angled design makes handling tire easier. Fits 2 door models only. Made in the USA.

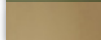

	Bare Metal	J0045491
	Black	J0041055
	Texturized Black	J0045501
	Southwest Blue	J0045494
	Playboy Blue	J0045495
	Neon Green	J0045497
	Fluorescent Orange	J0045492
	Locas Green	J0045499
	Military Beige	J0045500

	Pinky	J0045498
	Lemon Peel	J0045496
	Red Baron	J0045493
	Sinbad Purple	J0045503
	Cloud White	J0045504
	Gray Hammer'tn	J0045502
	Gecko Green	J0046573
	Hot Pink	J0046574
	Neon Yellow	J0046572

Steinjäger

FOOT PEGS

FOOT PEGS & CAN HOLDERS



Foot Pegs

Steinjäger's patented Foot Pegs are made in the USA of powder coated metal and an internal nonmetallic molded insert that protects your hinge while giving a snug fit for the Peg.
US Patent# 9,475,432.



	Black	J0041280
	Texturized Black	J0041560
	Southwest Blue	J0041282
	Playboy Blue	J0041283
	Neon Green	J0041284
	Fluorescent Orange	J0041285
	Locas Green	J0041286
	Military Beige	J0041287
	Pinky	J0041288

	Lemon Peel	J0041289
	Red Baron	J0041290
	Sinbad Purple	J0043459
	Cloud White	J0043460
	Gray Hammer'tn	J0041337
	Gecko Green	J0046495
	Hot Pink	J0046496
	Neon Yellow	J0046494
	Hydrographics	J0046926

Magnetic Can Holder



J0030968

Poly encased magnet holds a standard 12 oz can with a 2.75" OD.

Top mount style



J0031228

Poly encased magnet holds a standard 12 oz can with a 2.75" OD.

Side mount style

Doorless Can Holder



J0031196

Fits in door hinge.

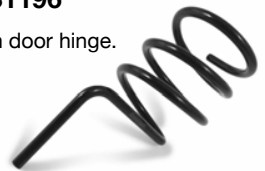

Holds a 12 oz can.

Yard Can Holder

32" high **J0031197**

48" high **J0031198**

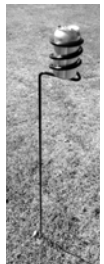

LIMB RISERS & LATCHES

LIMB RISERS & HOOD LATCHES



Metal Hood Latch Kits



J0041024

Steinjäger Hood Latch Kits eliminate Jeep hood flutter. Installation requires drilling with a 33/64 drill bit along with basic hand tools. Installation takes one hour.

Poly Hood Latch Kits



Black **J0041036**



Red **J0043480**

Steinjäger's molded polyurethane hood latch kits are easy to install. Installation requires masking tape, locking pliers and phillips screw drivers - takes only 15 minutes. Made in the USA.

Limb Riser

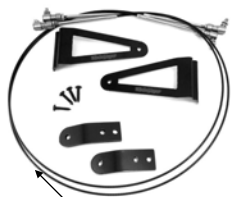

Non-Metallic Jacket
Protects from Scratching



J0040942



Our Limb Risers are made in the USA of stainless wire rope with a non-metallic jacket, stainless quick disconnect ball joints, and powder coated steel mounting brackets. Some drilling required for installation.

Do it Yourself Limb Riser Cables

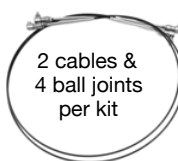

2 cables &
4 ball joints
per kit

We've had so many requests for our special non-metallic coated stainless wire cable and quick disconnect stainless ball joints for applications other than the Jeep Wranglers, that we now offer the cable and ball joint as a kit.

Lengths are ball joint stud to ball joint stud...

J0045634	48.5"	J0045641	55.5"
J0045635	49.5"	J0045642	56.5"
J0045636	50.5"	J0045643	57.5"
J0045637	51.5"	J0045644	58.5"
J0045638	52.5"	J0045645	59.5"
J0045639	53.5"	J0045656	61.5"
J0045640	54.5"	J0045647	63.5"

DIY Limb Risers Brackets



fits JK **J0045633**

Fits the JK Hood Latch.



Steinjäger

DOOR ACCENTS

STYLE



Door Handle Accents

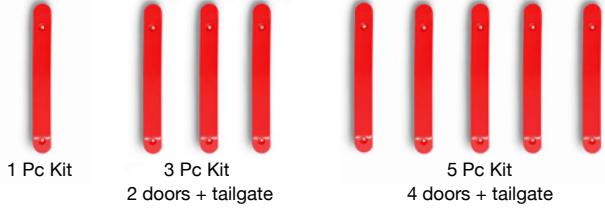

Add a splash of color and style to your factory door handles with the addition of these easy to install Door Handle Accents. Simply mark the hole locations using the accent piece as your template and pre-drill a 3/32" pilot hole. Made in the USA.

	<u>1 Pc Kit</u>	<u>3 Pc Kit</u>	<u>5 pc Kit</u>
	Bare Metal J0045425	J0045402	J0045403
	Black J0045426	J0044792	J0044806
	Texturized Black J0045436	J0044802	J0044816
	Southwest Blue J0045429	J0044795	J0044809
	Playboy Blue J0045430	J0044796	J0044810
	Neon Green J0045432	J0044798	J0044812
	Fluorescent Orange J0045427	J0044793	J0044807
	Locas Green J0045434	J0044800	J0044814
	Military Beige J0045435	J0044801	J0044815
	Pinky J0045433	J0044799	J0044813
	Lemon Peel J0045431	J0044797	J0044811
	Red Baron J0045428	J0044794	J0044808
	Sinbad Purple J0045438	J0044804	J0044818
	Cloud White J0045439	J0044805	J0044819
	Gray Hammertone J0045437	J0044803	J0044817
	Gecko Green J0046710	J0046549	J0046552
	Hot Pink J0046711	J0046550	J0046553
	Neon Yellow J0046709	J0046548	J0046551

RELOCATION KITS

LICENSE PLATES & VACUUM PUMP



License Plate Relocation Kit



The Steinjäger License Plate Relocation Bracket gives you a quick and easy way to attach and detach your license plate when you need to use your winch. Simply remove the thumbscrews and place in a safe location. Installation requires only that you loosen, not remove, the fairlead and slip the bracket behind. There is no need to remove your hook or safety thimble. Made in the USA.

	Bare Metal	J0045831
	Black	J0045832
	Texturized Black	J0045842
	Southwest Blue	J0045835
	Playboy Blue	J0045836
	Neon Green	J0045838
	Fluorescent Orange	J0045833
	Locas Green	J0045840
	Military Beige	J0045841

	Pinky	J0045839
	Lemon Peel	J0045837
	Red Baron	J0045834
	Sinbad Purple	J0045844
	Cloud White	J0045845
	Gray Hammer'tn	J0045843
	Gecko Green	J0046446
	Hot Pink	J0046447
	Neon Yellow	J0046445

Vacuum Pump Relocation Kit



J0041007



When installing an aftermarket bumper, it may be necessary to move your vacuum pump. This handy kit comes with all the needed hardware to complete this job. The vacuum pump is moved from behind the bumper to under the hood.

Molded Handle Holder

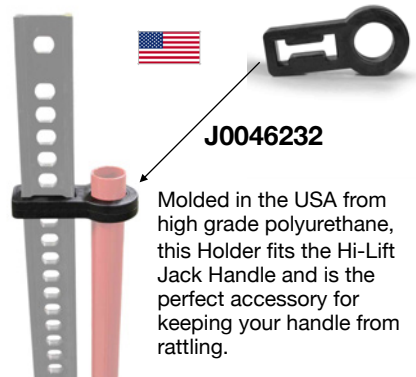

J0046232

Molded in the USA from high grade polyurethane, this Holder fits the Hi-Lift Jack Handle and is the perfect accessory for keeping your handle from rattling.



D-RING SHACKLES AND MOUNTS AND ISOLATORS



D-Ring Shackles



Our 3/4" D-Rings have a working load limit of 4.75 tons. Solid forged steel design. Imported forging, but powder coated in the USA.



	Zinc Plated	J0045662
	Black	J0045648
	Texturized Black	J0045658
	Southwest Blue	J0045651
	Playboy Blue	J0045652
	Neon Green	J0045654
	Fluorescent Orange	J0045649
	Locas Green	J0045656
	Military Beige	J0045657

	Pinky	J0045655
	Lemon Peel	J0045653
	Red Baron	J0045650
	Sinbad Purple	J0045660
	Cloud White	J0045661
	Gray Hammer'tn	J0045659
	Gecko Green	J0046440
	Hot Pink	J0046441
	Neon Yellow	J0046439

D-Ring Base Isolator



Molded in the USA, these isolators simply slide over the D-Ring, eliminating the metal on metal clanking noise. Easily removed when the D-Ring is needed for winching or pulling.

D-Ring Side Isolator



Molded in the USA, these isolators simply slide over the bolt of most standard 3/4" D-Rings. These will fit within mounts up to 3/4" wide. 2 pieces per kit.

D-RING MOUNTS & SPARE TIRE DELETE PLATES



D-Ring Mounts



Our D-Ring Mounts can be mounted to any bumper utilizing 1/2" bolt holes with a 5.1" x 2.5" bolt pattern. Kit includes 4 stainless steel allen head bolts with 1/2-13 threads.

	Bare Metal	J0045341
	Black	J0045327
	Texturized Black	J0045337
	Southwest Blue	J0045330
	Playboy Blue	J0045331
	Neon Green	J0045333
	Fluorescent Orange	J0045328
	Locas Green	J0045335
	Military Beige	J0045336
	Pinky	J0045334
	Lemon Peel	J0045332
	Red Baron	J0045329
	Sinbad Purple	J0045339
	Cloud White	J0045340
	Gray Hammer'tn	J0045338
	Gecko Green	J0046407
	Hot Pink	J0046408
	Neon Yellow	J0046406
	Hydrographics	J0046921

Spare Tire Delete Plates



Made in the USA from 1/8" steel. Uses factory bolts. Available with custom laser images or private labeling.

If you have removed the factory spare tire from your Jeep, you'll want our Delete Plate to cover the unsightly openings in the tailgate. Simply bolt on our Delete Plate to clean up the look of your Jeep.

	Bare Metal	J0043935
	Black	J0040922
	Texturized Black	J0043936
	Southwest Blue	J0043939
	Playboy Blue	J0043940
	Neon Green	J0043942
	Fluorescent Orange	J0043937
	Locas Green	J0043944
	Military Beige	J0043945
	Pinky	J0043943
	Lemon Peel	J0043941
	Red Baron	J0043938
	Sinbad Purple	J0043947
	Cloud White	J0043948
	Gray Hammer'tn	J0043946
	Gecko Green	J0046537
	Hot Pink	J0046538
	Neon Yellow	J0046536
	Hydrographics	J0046922

Steinjäger

HITCH ACCESSORIES











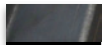

HITCH COVERS & FLAG POLE HOLDERS



Hitch Covers





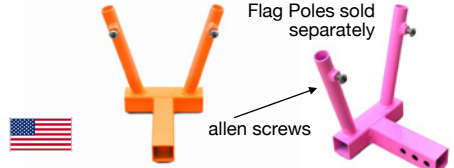

Our Hitch Cover makes an excellent accessory to cover up your unused hitch. Fits any standard 2" square hitch opening. Made in the USA.

	Bare Metal	J0046842
	Black	J0045799
	Texturized Black	J0045813
	Southwest Blue	J0045800
	Playboy Blue	J0045801
	Neon Green	J0045803
	Fluorescent Orange	J0045810
	Locas Green	J0045805
	Military Beige	J0045806
	Pinky	J0045804
	Lemon Peel	J0045802
	Red Baron	J0045811
	Sinbad Purple	J0045808
	Cloud White	J0045809
	Gray Hammer'tn	J0045807
	Gecko Green	J0046567
	Hot Pink	J0046568
	Neon Yellow	J0046566

Hitch Mounted Dual Flag Holder



Our Flag Holder fits any class 3 vehicle hitch. 3 offset holes allow for plenty of adjustment. 2 allen head bolts provide a means of securing the flag poles. Accepts around flag poles of 1" or less diameter. Made in the USA.

	Bare Metal	J0045890
	Black	J0045891
	Texturized Black	J0045901
	Southwest Blue	J0045894
	Playboy Blue	J0045895
	Neon Green	J0045897
	Fluorescent Orange	J0045892
	Locas Green	J0045899
	Military Beige	J0045900
	Pinky	J0045898
	Lemon Peel	J0045896
	Red Baron	J0045893
	Sinbad Purple	J0045903
	Cloud White	J0045904
	Gray Hammer'tn	J0045902
	Gecko Green	J0046434
	Hot Pink	J0046435
	Neon Yellow	J0046433

HITCH ACCESSORIES

FLAG POLES



Flag Poles



Our Flag Poles are made in the USA from 1" OD x 0.120" wall tubing. Hitch Mounts sold separately.

3.8' Long Poles

5.0' Long Poles

	Bare Metal	J0045709	J0045723
	Black	J0045710	J0045724
	Southwest Blue	J0045713	J0045727
	Playboy Blue	J0045714	J0045728
	Neon Green	J0045716	J0045730
	Fluorescent Orange	J0045711	J0045725
	Locas Green	J0045718	J0045732
	Military Beige	J0045719	J0045733
	Pinky	J0045717	J0045731
	Lemon Peel	J0045715	J0045729
	Red Baron	J0045712	J0045726
	Sinbad Purple	J0045721	J0045735
	Cloud White	J0045722	J0045736
	Gray Hammer'tn	J0045720	J0045734
	Gecko Green	J0046449	J0046452
	Hot Pink	J0046450	J0046453
	Neon Yellow	J0046448	J0046451

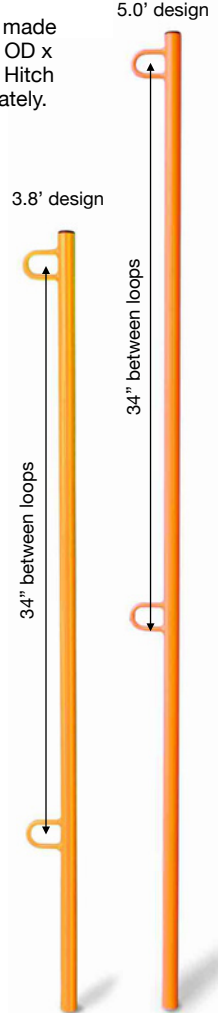

FABRIC TEDDY® TOPS

SOLAR SCREENS & CARGO COVERS



Teddy® Top Solar Screens for 2 Dr JK

Covers JK Front & Back Seats



Our Teddy® Top Solar Screens reduce direct sunlight, keeping both you and your Jeep cooler, and can remain on your Jeep long term as they are compatible with factory hard tops, soft tops, Steinjäger Teddy® Cargo Covers and Teddy® Cargo Nets.

Made in the USA.

Installation can be done by one person in 15 minutes.



Black J0041662



Blue J0043717



Burgundy J0043723



Gray J0043718



Green J0043720



Green, Dark J0043724



Mauve J0043725



Orange J0041663



Red J0043722



Tan J0043719



White J0043716



Yellow J0043721

Cargo Covers for JK (2 Door)



Our Cargo Covers install in under 5 minutes and help keep your cargo inside your Jeep when you have your soft top down or your hard top off. Made in the USA.

For JKU (4 Door)



FABRIC TEDDY® TOPS

AMERICAN MADE TOPS



Teddy® Top Solar Screens



Covers JKU Front & Back Seats



Our Teddy® Top Solar Screens reduce direct sunlight, keeping both you and your Jeep cooler. Our Teddy® Top Solar Screen can remain on your Jeep long term as it is compatible with factory hard tops, soft tops, Steinjäger Teddy® Cargo Covers and Teddy® Cargo Nets. Made in the USA. Installation can be done by one person in 15 minutes.

2007-2009 Model Years

2010-2017 Model Years



Black	J0041463	J0041320
Blue	J0043697	J0043731
Burgundy	J0043703	J0043693
Gray	J0043698	J0043732
Green	J0043700	J0043734
Green, Dark	J0043704	J0043694
Mauve	J0043705	J0043695
Orange	J0041464	J0041465
Red	J0043702	J0043736
Tan	J0043699	J0043733
White	J0043696	J0043730
Yellow	J0043701	J0043735

Steinjäger

FABRIC TEDDY® TOPS

AMERICAN MADE ACCESSORIES



Covers **FRONT** seat **ONLY**
Fits **BOTH JK and JKU**

Teddy® Top Solar Screens

Covers front seat only
Fits both JK (2 door) and JKU (4 door)

Our Teddy® Top Solar Screens reduce direct sunlight, keeping both you and your Jeep cooler. Our Teddy® Top Solar Screen can remain on your Jeep long term as it is compatible with factory hard tops, soft tops, Steinjäger Teddy® Cargo Covers and Teddy® Cargo Nets. Made in the USA. Covers front seats *only*. Installation can be done by one person in 15 minutes.



	<u>2007-2009 Model Years</u>	<u>2010-2017 Model Years</u>
Black	J0043976	J0043993
Blue	J0043979	J0043996
Burgundy	J0043985	J0044002
Gray	J0043980	J0043997
Green	J0043982	J0043999
Green, Dark	J0043986	J0044003
Mauve	J0043987	J0044004
Orange	J0043977	J0043994
Red	J0043984	J0044001
Tan	J0043981	J0043998
White	J0043978	J0043995
Yellow	J0043983	J0044000



TEDDY® CARGO NETS

AMERICAN MADE ACCESSORIES



JK- 2" Wide Cargo Nets



- Black J0045964
- Blue J0047014
- Gray J0047015
- Orange J0047016
- Red J0047017

JKU - 2" Wide Nets



- Black J0046253
- Blue J0047022
- Gray J0047023
- Orange J0047024
- Red J0047025

Our Teddy® Top Cargo Nets cover the back half and sides of your Jeep, and can remain on your Jeep long term as they are compatible with factory hard tops, soft tops, Steinjäger Teddy® Fabric Tops and Teddy® Cargo Nets. The open design allows for great visibility while keeping your cargo inside of the vehicle. Made in the USA. Installation can be done by one person in 15 minutes.



LED BRACKETS

AMERICAN MADE BRACKETS



Lower Windshield Bracket



Hood Mounted Bracket



LED Lights available online



LED Lights available online

	Bare Metal	J0041660
	Black	J0040929
	Texturized Black	J0041571
	Southwest Blue	J0041564
	Playboy Blue	J0041565
	Neon Green	J0041567
	Fluorescent Orange	J0041562
	Locas Green	J0041569
	Military Beige	J0041570
	Pinky	J0041568
	Lemon Peel	J0041566
	Red Baron	J0041563
	Sinbad Purple	J0043974
	Cloud White	J0043975
	Gray Hammer'tn	J0041572
	Gecko Green	J0046392
	Hot Pink	J0046393
	Neon Yellow	J0046391
	Hydrographics	J0046904

	Bare Metal	J0041441
	Black	J0041042
	Texturized Black	J0041439
	Southwest Blue	J0041432
	Playboy Blue	J0041433
	Neon Green	J0041435
	Fluorescent Orange	J0041430
	Locas Green	J0041437
	Military Beige	J0041438
	Pinky	J0041436
	Lemon Peel	J0041434
	Red Baron	J0041431
	Sinbad Purple	J0043607
	Cloud White	J0043609
	Gray Hammer'tn	J0041440
	Gecko Green	J0046510
	Hot Pink	J0046511
	Neon Yellow	J0046509
	Hydrographics	J0046903

LED BRACKETS

AMERICAN MADE BRACKETS



External Grill Bracket





















LED Lights available online

Bumper Light Bar



LED Lights available online

	Bare Metal	J0041402
	Black	J0041388
	Texturized Black	J0041401
	Southwest Blue	J0041393
	Playboy Blue	J0041394
	Neon Green	J0041396
	Fluorescent Orange	J0041391
	Locas Green	J0041398
	Military Beige	J0041399
	Pinky	J0041397
	Lemon Peel	J0041395
	Red Baron	J0041392
	Sinbad Purple	J0044773
	Cloud White	J0044774
	Gray Hammer'tn	J0041400
	Gecko Green	J0046395
	Hot Pink	J0046396
	Neon Yellow	J0046394
	Hydrographics	J0046902

	Bare Metal	J0045700
	Black	J0045688
	Texturized Black	J0045699
	Southwest Blue	J0045691
	Playboy Blue	J0045692
	Neon Green	J0045694
	Fluorescent Orange	J0045689
	Locas Green	J0045696
	Military Beige	J0045697
	Pinky	J0045695
	Lemon Peel	J0045693
	Red Baron	J0045690
	Sinbad Purple	J0046852
	Cloud White	J0046853
	Gray Hammer'tn	J0045698
	Gecko Green	J0046850
	Hot Pink	J0046851
	Neon Yellow	J0046849

Steinjäger

ROCK SLIDERS

FOR JK... 'BARE KNUCKLES' DESIGN



Rock Sliders 



- | | |
|-------------------|----------|
| Bare Metal | J0046840 |
| Black | J0044820 |
| Texturized Black | J0044830 |
| Southwest Blue | J0044823 |
| Playboy Blue | J0044824 |
| Neon Green | J0044826 |
| Fl'rescent Orange | J0044821 |
| Locas Green | J0044828 |
| Military Beige | J0044829 |
| Pinky | J0044827 |
| Lemon Peel | J0044825 |
| Red Baron | J0044822 |
| Sinbad Purple | J0044832 |
| Cloud White | J0044833 |
| Gray Hammer'tn | J0044831 |
| Gecko Green | J0046398 |
| Hot Pink | J0046399 |
| Neon Yellow | J0046397 |
| Hydrographics | J0046968 |



Steinjäger

ROCK SLIDERS

FOR JKU... 'BARE KNUCKLES' DESIGN











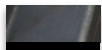

Rock Sliders

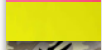

These simple to install rock sliders utilize the three body mounts on each side. Simply remove the body bolts and install the rock sliders with the new hardware supplied.

Made in the USA from 1.75" OD ASTM 513 Type 1 Tubing.

	Bare Metal	J0046880
	Black	J0043899
	Texturized Black	J0043931
	Southwest Blue	J0043924
	Playboy Blue	J0043925
	Neon Green	J0043927
	Fluorescent Orange	J0043922
	Locas Green	J0043929
	Military Beige	J0043930
	Pinky	J0043928
	Lemon Peel	J0043926
	Red Baron	J0043923
	Sinbad Purple	J0043933
	Cloud White	J0043934
	Gray Hammer'tn	J0043932
	Gecko Green	J0046389
	Hot Pink	J0046390
	Neon Yellow	J0046388
	Hydrographics	J0046969



Steinjäger

10,000 Combinations Possible

INSERT ROCK SLIDERS FOR JK... 'PHANTOM' DESIGN



Rock Sliders & Inserts



Phantom' Rock Slider Insert

Bare Metal	J0044897	J0044864
Black	J0044896	J0044867
Texturized Black	J0044907	J0044877
Southwest Blue	J0044900	J0044870
Playboy Blue	J0044901	J0044871
Neon Green	J0044903	J0044873
Fl'orescent Orange	J0044898	J0044868
Locas Green	J0044905	J0044875
Military Beige	J0044906	J0044876
Pinky	J0044904	J0044874
Lemon Peel	J0044902	J0044872
Red Baron	J0044899	J0044869
Sinbad Purple	J0044909	J0044879
Cloud White	J0044910	J0044880
Gray Hammer'tn	J0044908	J0044878
Gecko Green	J0046404	J0046555
Hot Pink	J0046405	J0046556
Neon Yellow	J0046403	J0046554
Hydrographics	J0046970	J0046971



10,000 Combinations Possible

INSERT ROCK SLIDERS FOR JKU... 'PHANTOM' DESIGN



Rock Sliders & Inserts

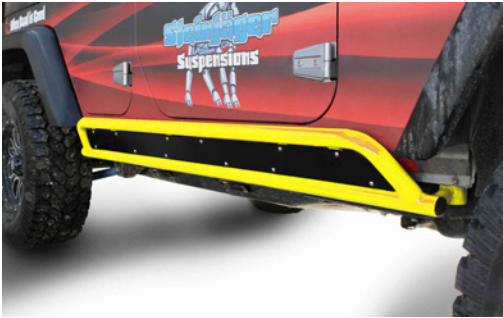

These simple to install 'phantom' rock sliders utilize the three body mounts on each side. Simply remove the body bolts and install the rock sliders with the new hardware supplied. Then, pick your insert. Made in the USA from 1.75" OD ASTM 513 Type 1 Tubing.

With Steinjäger's line up of 100 different powder coat colors and hydrographic options, you have 10,000 ways to customize your Jeep!



Phantom Rock Slider Insert

Bare Metal	J0044895	J0044863
Black	J0044881	J0044849
Texturized Black	J0044891	J0044859
Southwest Blue	J0044884	J0044852
Playboy Blue	J0044885	J0044853
Neon Green	J0044887	J0044855
Fl'orescent Orange	J0044882	J0044850
Locas Green	J0044889	J0044857
Military Beige	J0044890	J0044858
Pinky	J0044888	J0044856
Lemon Peel	J0044886	J0044854
Red Baron	J0044883	J0044851
Sinbad Purple	J0044893	J0044861
Cloud White	J0044894	J0044862
Gray Hammer'tn	J0044892	J0044860
Gecko Green	J0046401	J0046546
Hot Pink	J0046402	J0046547
Neon Yellow	J0046400	J0046545
Hydrographics	J0046972	J0046973



Steinjäger

SWAY BARS

SUSPENSION PARTS & SYSTEMS



Front Sway Bars



J0040928

adjustable

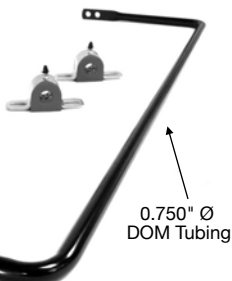

0.750" Ø
DOM Tubing



J0046945 hydrodipped

This undersized adjustable front sway bar helps improve stability at higher speeds, and gives you more flex when off-roading.

Stainless Front Sway Bar End Links



0.0"-2.0" Lift 2.5-5.0" Lift 5.5-8.0" Lift

	Black	J0047132	J0047149	J0047166
	Texturized Black	J0047145	J0047162	J0047179
	Southwest Blue	J0047135	J0047152	J0047169
	Playboy Blue	J0047136	J0047153	J0047170
	Neon Green	J0047138	J0047155	J0047172
	Fluorescent Orange	J0047133	J0047150	J0047167
	Locas Green	J0047140	J0047157	J0047174
	Military Beige	J0047141	J0047158	J0047175
	Pinky	J0047139	J0047156	J0047173
	Lemon Peel	J0047137	J0047154	J0047171
	Red Baron	J0047134	J0047151	J0047168
	Sinbad Purple	J0047143	J0047160	J0047177
	Cloud White	J0047144	J0047161	J0047178
	Gray Hammer'tn	J0047142	J0047159	J0047176
	Gecko Green	J0047147	J0047164	J0047181
	Hot Pink	J0047148	J0047165	J0047182
	Neon Yellow	J0047146	J0047163	J0047180



- Stainless Heim Joints
- Stainless Ball Joints
- Stainless Rod
- Stainless Nuts
- Stainless Bolts

Includes sway bar hanger kit.

Stainless Rods are powder coated in the non-threaded area.

Sway Bar Hanger Kit



Hold your sway bar and end links out of the way when they are disconnected. Made the USA.



Black **J0043954**



Blue **J0043955**



Gray **J0043957**



Orange **J0043958**



Red **J0043956**

SWAY BAR END LINKS

SUSPENSION PARTS & SYSTEMS



Quick Disconnect End Links



Front

0.0 - 2.0" Lift Height **J0030554**

2.5 - 5.0" Lift Height **J0030555**

5.5 - 8.0" Lift Height **J0030556**

Zinc Plated steel Rod is threaded Left Hand and Right Hand to allow easy length adjustments.

Metal-on-Metal Spring Loaded Ball Joint with M12 x 1.75" Threads provides strength and ease of disconnecting.



Rear

0.0 - 2.0" Lift Height **J0031035**

2.5 - 5.0" Lift Height **J0031036**

5.5 - 8.0" Lift Height **J0031037**

Similar design to front links, except we've added a rubber boot to help protect the heims. Rod lengths based on rear geometry.

NON Disconnecting End Links



Front

0.0 - 2.0" **J0041011**

2.5 - 5.0" **J0041012**

5.5 - 8.0" **J0041013**

Rear

0.0 - 2.0" **J0030557**

2.5 - 5.0" **J0030558**

5.5 - 8.0" **J0030559**

Do It Yourself End Links



J0031207



Kit includes...

- (2) 18" pieces of 1" OD x 0.095 DOM Tube
- (2) RH and (2) LH Chrome Moly Heims
- (4) RH Studs already staked into Heims
- (2) RH and (2) LH Moly Thread Bungs
- (4) RH Lock Nuts, (2) RH and (2) LH Jams
- (4) Heim Rubber Boots

Steinjäger

FRONT TRACK BARS

SUSPENSION PARTS & SYSTEMS



Premium Front Track Bars



Fits stock to 6 inch lifts

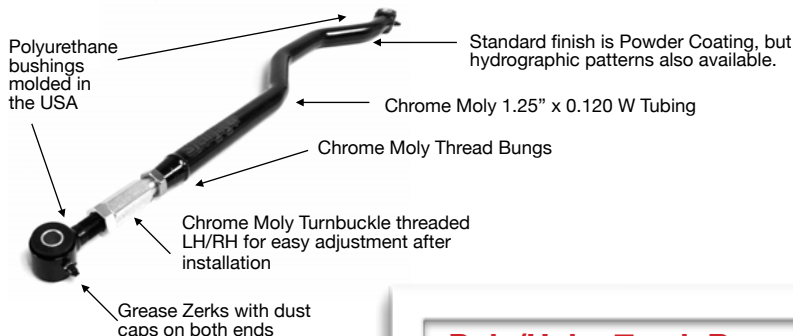

Bare Metal	J0046168
Black	J0044777
Texturized Black	J0046178
Southwest Blue	J0046171
Playboy Blue	J0046172
Neon Green	J0046174
Fl'orescent Orange	J0046169
Locas Green	J0046176
Military Beige	J0046177
Pinky	J0046175
Lemon Peel	J0046173
Red Baron	J0046170
Sinbad Purple	J0046180
Cloud White	J0046181
Gray Hammer'tn	J0046179
Gecko Green	J0046588
Hot Pink	J0046589
Neon Yellow	J0046587
Hydrographics	J0046928

Poly/Heim Track Bars

For stock to 6" Lifts
 Chrome Moly Tubing
 Chrome Moly Heim



Same features as poly poly designs!

J0044782

Track Bar Rebuild Kit

Fits Steinjäger Track Bars



J0045404

REAR PANHARD BARS

SUSPENSION PARTS & SYSTEMS



Rear Panhard Bars



Fits stock to 6 inch lifts

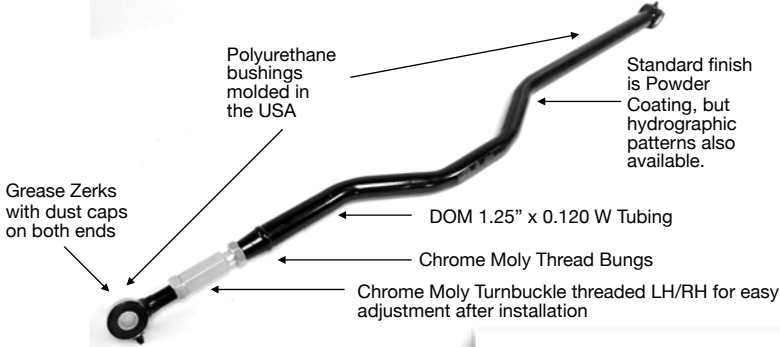

	Bare Metal	J0046813
	Black	J0031389
	Texturized Black	J0046611
	Southwest Blue	J0046601
	Playboy Blue	J0046602
	Neon Green	J0046604
	Fl'rescent Orange	J0046599
	Locas Green	J0046606
	Military Beige	J0046607
	Pinky	J0046605
	Lemon Peel	J0046603
	Red Baron	J0046600
	Sinbad Purple	J0046609
	Cloud White	J0046610
	Gray Hammer'tn	J0046608
	Gecko Green	J0046613
	Hot Pink	J0046614
	Neon Yellow	J0046612
	Hydrographics	J0046931

J0044778 Chrome Moly Black Panhard

Poly/Heim Panhards

For stock to 6" Lifts
 Chrome Moly Heim
 Same features as
 poly poly designs!

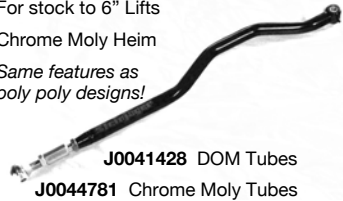

Panhard Rebuild Kit

Fits Steinjäger Panhard Bars



Steinjäger

CONTROL ARMS

SUSPENSION PARTS & SYSTEMS



Made in the USA

Standard finish is Powder Coating, but hydrographic patterns also available.

Poly Bushings have grease zerks

Front Lower



Front Uppers



Front Lower Control Arms

Lift & Tube Size -> 0-2.5" Lift, 1.750 x 0.12 Tube 2.5-4.0" Lift, 1.750 x 0.250 Tube

Tube Material -> DOM Steel 304 Stainless DOM Steel 304 Stainless

Black	J0041277	J0047098	J0041278	J0047030
Text Black	J0046751	J0047108	J0047002	J0047043
SW Blue	J0046744	J0047101	J0046995	J0047033
Playboy Blue	J0046745	J0047102	J0046996	J0047034
Neon Green	J0046747	J0047104	J0046998	J0047036
FL Orange	J0046742	J0047099	J0046993	J0047031
Locas Green	J0046749	J0047106	J0047000	J0047038
Military Beige	J0046750	J0047107	J0047001	J0047039
Pinky	J0046748	J0047105	J0046999	J0047037
Lemon Peel	J0046746	J0047103	J0046997	J0047035
Red Baron	J0046743	J0047100	J0046994	J0047032
Sinbad Purple	J0046753	J0047110	J0047004	J0047041
Cloud White	J0046754	J0047111	J0047005	J0047042
Gray Hammer	J0046752	J0047109	J0047003	J0047040
Gecko Green	J0046756	J0047113	J0047007	J0047045
Hot Pink	J0046757	J0047114	J0047008	J0047046
Neon Yellow	<u>J0046755</u>	<u>J0047112</u>	<u>J0047006</u>	<u>J0047044</u>

Front Upper Control Arms

0.0-4.0" Lift, 1.50 x 0.120 Tube

DOM Steel 304 Stainless

J0041275	J0047081
J0046768	J0047094
J0046761	J0047084
J0046762	J0047085
J0046764	J0047087
J0046759	J0047082
J0046766	J0047089
J0046767	J0047090
J0046765	J0047088
J0046763	J0047086
J0046760	J0047083
J0046770	J0047092
J0046771	J0047093
J0046769	J0047091
J0046773	J0047096
J0046774	J0047097
<u>J0046772</u>	<u>J0047095</u>

Hydrodipped J0046907

J0046911

J0046908

Steinjäger

CONTROL ARMS

SUSPENSION PARTS & SYSTEMS



Made in the USA

Standard finish is Powder Coating, but hydrographic patterns also available.

Poly Bushings have grease zerks

Rear Lower Control Arms



Rear Uppers



Rear Lower Control Arms

Lift & Tube Size -> 0-2.5" Lift, 1.750 x 0.12 Tube 2.5-4.0" Lift, 1.750 x 0.250 Tube

Tube Material -> DOM Steel 304 Stainless DOM Steel 304 Stainless

Black	J0041273	J0047115	J0041274	J0047047
Text Black	J0046833	J0047125	J0046984	J0047060
SW Blue	J0046826	J0047118	J0046977	J0047050
Playboy Blue	J0046827	J0047119	J0046978	J0047051
Neon Green	J0046829	J0047121	J0046980	J0047053
FL Orange	J0046824	J0047116	J0046975	J0047048
Locas Green	J0046831	J0047123	J0046982	J0047055
Military Beige	J0046832	J0047124	J0046983	J0047056
Pinky	J0046830	J0047122	J0046981	J0047054
Lemon Peel	J0046828	J0047120	J0046979	J0047052
Red Baron	J0046825	J0047117	J0046976	J0047049
Sinbad Purple	J0046835	J0047127	J0046986	J0047058
Cloud White	J0046836	J0047128	J0046987	J0047059
Gray Hammer	J0046834	J0047126	J0046985	J0047057
Gecko Green	J0046838	J0047130	J0046989	J0047062
Hot Pink	J0046839	J0047131	J0046990	J0047063
Neon Yellow	<u>J0046837</u>	<u>J0047129</u>	<u>J0046988</u>	<u>J0047061</u>

Rear Uppers

0.0-4.0" Lift, 1.50 x 0.120 Tube

DOM Steel 304 Stainless

J0041271	J0047064
J0046785	J0047074
J0046778	J0047067
J0046779	J0047068
J0046781	J0047070
J0046776	J0047065
J0046783	J0047072
J0046784	J0047073
J0046782	J0047071
J0046780	J0047069
J0046777	J0047066
J0046787	J0047076
J0046788	J0047077
J0046786	J0047075
J0046790	J0047079
J0046791	J0047080
<u>J0046789</u>	<u>J0047078</u>

Hydrodipped J0046909

J0046913

J0046910

Steinjäger

SPRINGS FOR LIFT KITS

SUSPENSION PARTS & SYSTEMS



Suspension Coil Springs



Made in the USA

Each kit includes two Springs.

Springs are **single rate**.

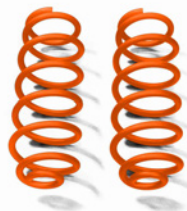
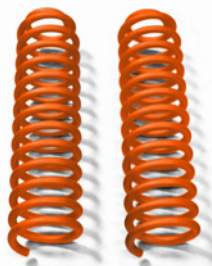

Front Coil Springs

Rear Coil Springs

Lift Height ->

0.0-2.5" Lift

4.0" Lift

0.0-2.5" Lift

4.0" Lift



Bare Metal

J0046644

J0046616

J0046645

J0046617

Black

J0046646

J0046618

J0046663

J0046619

Southwest Blue

J0046649

J0046622

J0046666

J0046634

Playboy Blue

J0046650

J0046623

J0046667

J0046635

Neon Green

J0046652

J0046625

J0046669

J0046637

Fl'orescent Orange

J0046647

J0046620

J0046664

J0046632

Locas Green

J0046654

J0046627

J0046671

J0046639

Military Beige

J0046655

J0046628

J0046672

J0046640

Pinky

J0046653

J0046626

J0046670

J0046638

Lemon Peel

J0046651

J0046624

J0046668

J0046636

Red Baron

J0046648

J0046621

J0046665

J0046633

Sinbad Purple

J0046658

J0046630

J0046675

J0046642

Cloud White

J0046659

J0046631

J0046676

J0046643

Gray Hammer'tn

J0046657

J0046629

J0046674

J0046641

Gecko Green

J0046661

J0046684

J0046678

J0046685

Hot Pink

J0046662

J0046688

J0046679

J0046689

Neon Yellow

J0046660

J0046680

J0046677

J0046681

Steinjäger



2.5" LIFT KITS

SUSPENSION PARTS & SYSTEMS



JKU

Lift Kits, 2.5" for JK and JKU

Lifetime Warranty
on track bar, panhard bar, control arms, and poly bushings. One year warranty on springs and end links. These kits are designed for moderate off-road use. Made in the USA.

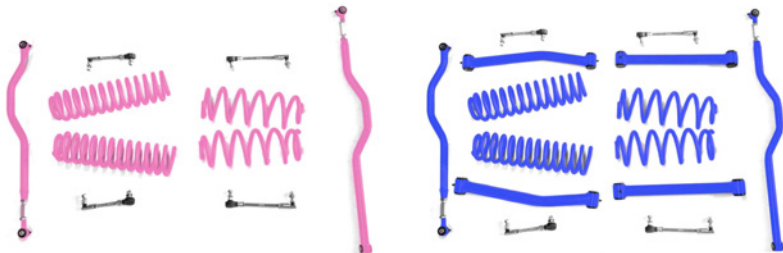

Bare Metal	J0046812	J0046899
Texturized Black	J0046692	J0046882
Black	J0046702	J0046892
Southwest Blue	J0046695	J0046885
Playboy Blue	J0046696	J0046886
Neon Green	J0046698	J0046888
Fluorescent Orange	J0046693	J0046883
Locas Green	J0046700	J0046890
Military Beige	J0046701	J0046891
Pinky	J0046699	J0046889
Lemon Peel	J0046697	J0046887
Red Baron	J0046694	J0046884
Sinbad Purple	J0046704	J0046894
Cloud White	J0046705	J0046895
Gray Hammer'tn	J0046703	J0046893
Gecko Green	J0046707	J0046897
Hot Pink	J0046708	J0046898
Neon Yellow	J0046706	J0046896

- Panhard Bar is 1.250" x 0.120" W DOM Tubing.
- Track Bar is 1.250" x 0.120 W Chrome Moly Tubing.
- Thread Bungs are Chrome Moly.
- Double Adjustable Panhard Bar and Track Bar.

- End Links come with rubber Dust Boots
- All Track Bars, Panhard Bars, Springs and Control Arms are Powder Coated.
- All Poly Bushings have a Grease Zerk & Cap.

Add 4 Pro Comp ES9000 shocks. Use part# J0047183. Add 4 Bilstein 5100 shocks. Use part# J0047185.

Steinjäger

2.5" LIFT KITS

SUSPENSION PARTS & SYSTEMS



Lift Kits, 2.5" for JK and JKU

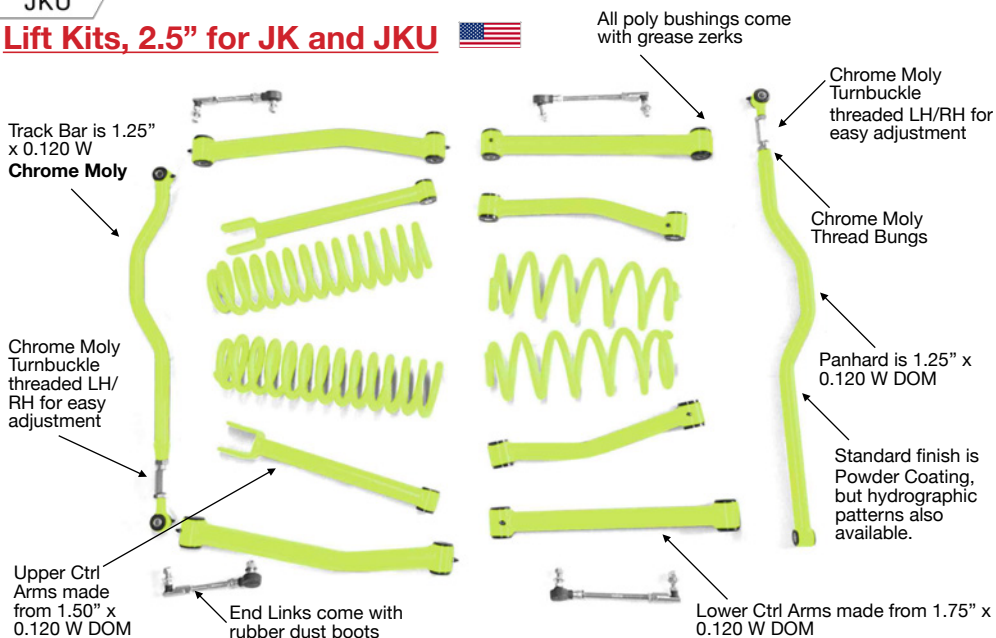

Lifetime Warranty on the control arms, track bar, and panhard bar, including the poly bushings. One year warranty on springs and end links. These kits are designed for moderate off-road use.



Bare Metal	J0046967
Black	J0046950
Texturized Black	J0046960
Southwest Blue	J0046953
Playboy Blue	J0046954
Neon Green	J0046956
Fluorescent Orange	J0046951
Locas Green	J0046958
Military Beige	J0046959

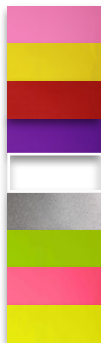

Pink	J0046957
Lemon Peel	J0046955
Red Baron	J0046952
Sinbad Purple	J0046962
Cloud White	J0046963
Gray Hammer'tn	J0046961
Gecko Green	J0046965
Hot Pink	J0046966
Neon Yellow	J0046964

Add 4 Pro Comp ES9000 shocks. Use part# J0047183.
Add 4 Bilstein 5100 shocks. Use part# J0047185.



4.0" LIFT KITS

SUSPENSION PARTS & SYSTEMS



Lift Kits, 4" for JK and JKU



All poly bushings come with grease zerks

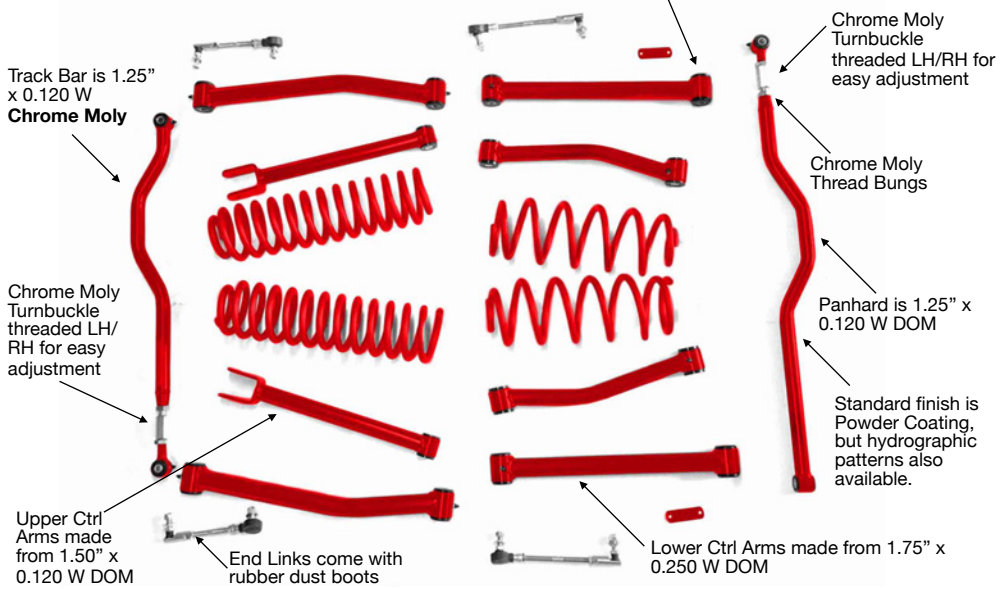

Lifetime Warranty on the control arms, track bar, and panhard bar, including the poly bushings. One year warranty on springs and end links. These kits are designed for moderate off-road use.

	Bare Metal	J0044941
	Black	J0041262
	Texturized Black	J0044937
	Southwest Blue	J0044930
	Playboy Blue	J0044931
	Neon Green	J0044933
	Fluorescent Orange	J0044928
	Locas Green	J0044935
	Military Beige	J0044936

	Pink	J0044934
	Lemon Peel	J0044932
	Red Baron	J0044929
	Sinbad Purple	J0044939
	Cloud White	J0044940
	Gray Hammer'tn	J0044938
	Gecko Green	J0046561
	Hot Pink	J0046562
	Neon Yellow	J0046560

Add 4 Pro Comp ES9000 shocks. Use part# J0047183.
Add 4 Bilstein 5100 shocks. Use part# J0047185.



TUBULAR DOORS

USA MADE FOR TJ AND LJ





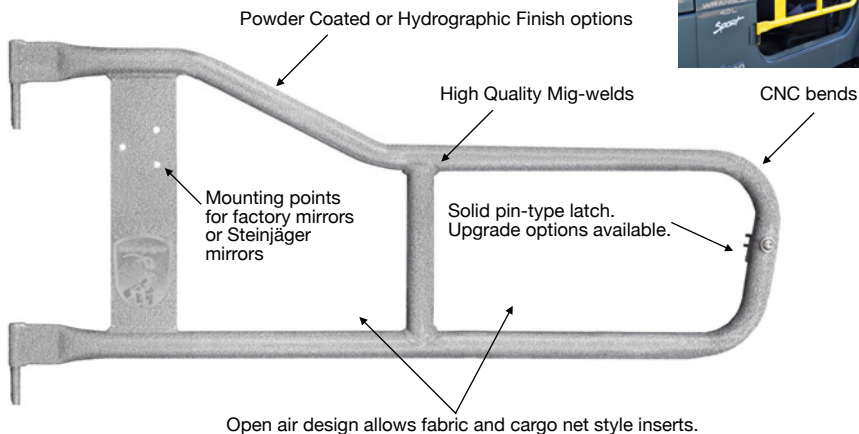





TUBULAR DOORS FOR TJ & LJ



Open air design allows fabric and cargo net style inserts.

	Bare Metal	J0041331
	Black	J0029673
	Texturized Black	J0041016
	Southwest Blue	J0040989
	Playboy Blue	J0040990
	Neon Green	J0040991
	FL Orange	J0040992
	Locas Green	J0040993
	Military Beige	J0040994
	Pinky	J0040995

	Lemon Peel	J0040996
	Red Baron	J0040997
	Sinbad Purple	J0042641
	Cloud White	J0042642
	Gray Hammert'n	J0041338
	Gecko Green	J0046489
	Hot Pink	J0046490
	Neon Yellow	J0046488
	Hydrographics	J0046816

Tube Door Limiting Straps



Fits Steinjäger Tube Doors on TJ, YJ, CJ-7 & CJ-8

J0041621

2 straps per kit



DOOR HOLDERS

FOR TJ, YJ, CJ-7 AND CJ-8



TJ

WALL MOUNTED DOOR HANGER

Holds Two Doors Mounts to wall studs and holds factory and tubular doors.



Color

Part#

	Bare Metal	J0044946
	Black	J0030813
	Texturized Black	J0044956
	Southwest Blue	J0044949
	Playboy Blue	J0044950
	Neon Green	J0044952
	Fluorescent Orange	J0044947
	Locas Green	J0044954
	Military Beige	J0044955
	Pinky	J0044953
	Lemon Peel	J0044951
	Red Baron	J0044948
	Sinbad Purple	J0044958
	Cloud White	J0044959
	Gray Hammertone	J0044957
	Gecko Green	J0046410
	Hot Pink	J0046411
	Neon Yellow	J0046409



Steinjäger Latch Upgrade



These handy latch upgrades make our great tube doors even better! Fits our JK & TJ tube doors.

Part# # of Pins

J0043481	1
J0043482	2
J0043483	4

Arm Rests



Color Part#

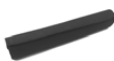

Black J0041034



Red J0046100



Blue J0046106

Made in the USA.
Fits Steinjäger JK,
TJ, YJ, CJ-7 &
CJ-8 tube doors.

Door Limiting Straps



For TJ stock doors.
2 Straps per kit.

Black **J0043901**
Blue **J0043905**
Gray **J0043904**
Orange **J0043902**
Red **J0043903**

Steinjäger

TUBULAR DOORS

DOOR COVERS & DOOR NETS



TJ

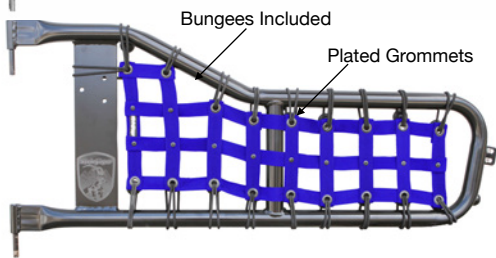
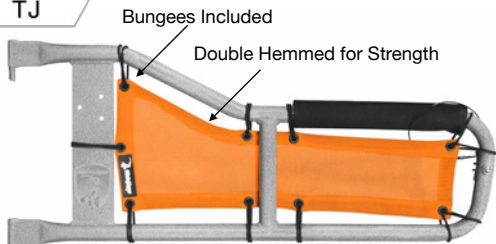

Door Covers



Made in the USA. Fits Steinjäger **TJ, YJ, CJ-7** and **CJ-8** tube doors.



Black J0041190



Orange J0041625



White J0041626

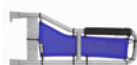

Royal Blue J001627



Gray J0041628



Lemon Yellow J0041631



Red J0041632



Burgundy J0043599



Green, Dark J0043600



Mauve J0043858

Door Nets



Made in the USA. Fits Steinjäger **TJ** tube doors.

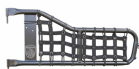

Black J0043570



Orange J0043689



Gray J0043690

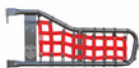

Red J0043691

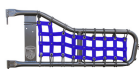

Blue J0043692

MIRRORS FOR DOORS & HINGES



TJ

Mirror Kits to fit Steinjäger TJ, YJ, CJ-7 & CJ-8 Doors



Fits Steinjäger tube doors. Will also fit on factory doors.



Fits J0041326 Mirrors

	Black	J0046214
	Texturized Black	J0046227
	Southwest Blue	J0046226
	Playboy Blue	J0046223
	Neon Green	J0046221
	FL Orange	J0046216
	Locas Green	J0046219
	Military Beige	J0046220
	Pinky	J0046222
	Lemon Peel	J0046218
	Red Baron	J0046224
	Sinbad Purple	J0046225
	Cloud White	J0046215
	Gray Hammert'n	J0046217
	Gecko Green	J0046597
	Hot Pink	J0046598
	Neon Yellow	J0046596
	Hydrographics	J0046944

Magnetic Legs



2 Legs **J0046183**

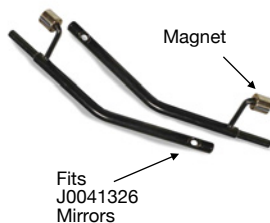

Fits J0041326 Mirrors

This patented design uses magnets to hold the legs in place. Allows quick removal of legs & mirrors from door hinge. Made in USA.

Mirrors

2 Mirrors **J0041326**

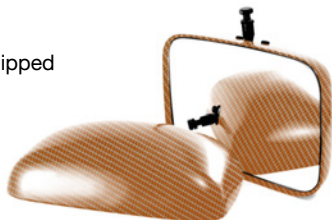

J0046938 2 mirrors hydrodipped

OVER 80 PATTERNS AVAILABLE



Steinjäger

GRAB HANDLES AND ACCESSORIES



Roll Bar Grab Handles



2 Handles with Black Grips **J0043462**



2 Handles with Red Grips **J0043478**

We mold and sew these handles in the USA. Designed to fit over the factory roll bar, these handles come ready for installation.

Overhead Organizers



Steinjäger's Overhead Organizers fit the TJ and LJ. Refer to page 15.



Molded Handle Holder



Steinjäger's makes Hi-Lift Jack Handle Holders. Refer to page 21.



Coat Hook



Steinjäger's Coat Hooks fit the TJ and LJ. Refer to page 15.



D-Rings

Steinjäger's D-Rings fit the TJ and LJ. Refer to page 22.



Stirrup Steps



Steinjäger's Stirrup Steps fit the TJ and LJ. Refer to page 13.



Winch Straps



Steinjäger's Winch Straps fit the TJ and LJ. Refer to page 12.

FOOT PEGS

MADE IN THE USA



Wire Foot Pegs

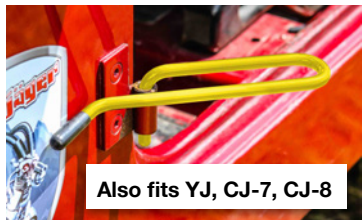

Also fits YJ, CJ-7, CJ-8

Metal Foot Pegs



Steinjäger's foot pegs are made in the USA. Both of our designs include a rubber or non-metallic component to prevent scratching. Do **NOT** operate your vehicle with any part of your body protruding beyond the vehicle. **Caution!**

	Bare Metal	J0045905
	Black	J0028970
	Texturized Black	J0045915
	Southwest Blue	J0045908
	Playboy Blue	J0045909
	Neon Green	J0045911
	FL Orange	J0045906
	Locas Green	J0045913
	Military Beige	J0045914
	Pinky	J0045912
	Lemon Peel	J0045910
	Red Baron	J0045907
	Sinbad Purple	J0045917
	Cloud White	J0045918
	Gray Hammert'n	J0045916
	Gecko Green	J0046576
	Hot Pink	J0046577
	Neon Yellow	J0046575
	Hydrographics	J0046927

	Black	J0043881
	Texturized Black	J0043891
	Southwest Blue	J0043884
	Playboy Blue	J0043885
	Neon Green	J0043887
	FL Orange	J0043882
	Locas Green	J0043889
	Military Beige	J0043890
	Pinky	J0043888
	Lemon Peel	J0043886
	Red Baron	J0043883
	Sinbad Purple	J0043893
	Cloud White	J0043894
	Gray Hammert'n	J0043892
	Gecko Green	J0046534
	Hot Pink	J0046535
	Neon Yellow	J0046533
	Hydrographics	J0046991

Steinjäger

WINCH PLATES AND LED BRACKETS



TJ

Brackets for 50" LED's





















Our 50" Light Bar Bracket utilizes the top of the windshield frame for a simple and sleek design. Includes mounting hardware and 2 brackets. LED lights also available online. Brackets are made in the USA.

Bolt On Winch Plate



Steinjäger's Bolt On Winch Plate is designed to work with your factory bumper and some aftermarket tube bumpers. It is mounted with the four top bumper bolts along with the front sway bar bolt. Made in the USA from 1/4" thick steel plate.

	Bare Metal	J0046794
	Black	J0046795
	Texturized Black	J0046805
	Southwest Blue	J0046798
	Playboy Blue	J0046799
	Neon Green	J0046801
	FL Orange	J0046796
	Locas Green	J0046803
	Military Beige	J0046804
	Pinky	J0046802
	Lemon Peel	J0046800
	Red Baron	J0046797
	Sinbad Purple	J0046807
	Cloud White	J0046808
	Gray Hammert'n	J0046806
	Gecko Green	J0046810
	Hot Pink	J0046811
	Neon Yellow	J0046809
	Hydrographics	J0046906

	Bare Metal	J0046867
	Black	J0046278
	Texturized Black	J0046288
	Southwest Blue	J0046281
	Playboy Blue	J0046282
	Neon Green	J0046284
	FL Orange	J0046279
	Locas Green	J0046286
	Military Beige	J0046287
	Pinky	J0046285
	Lemon Peel	J0046283
	Red Baron	J0046280
	Sinbad Purple	J0046290
	Cloud White	J0046291
	Gray Hammert'n	J0046289
	Gecko Green	J0046293
	Hot Pink	J0046294
	Neon Yellow	J0046292



LIMB RISERS & LATCHES

LIMB RISERS & HOOD LATCHES



Metal Hood Latch Kits



Eliminate Jeep hood flutter with these easy to install adjustable hood latches. Installation takes 1 hour and requires a drill with a 3/32 bit, along with basic hand tools.

Plated Steel **J0023990**

Chromed **J0023988**

Chrome Moly **J0023988**

Aluminum **J0023989**

Stainless Steel **J0023987**

Poly Hood Latch Kits



Red Poly **J0045424**

Black Poly **J0045423**



Eliminate Jeep hood flutter with these easy to install adjustable hood latches. Installation takes 15 minutes and requires masking tape, 2 pairs of locking pliers, and 2 phillips screw drivers.

Limb Riser Kit



J0030944

Our Limb Risers are made in the USA of stainless wire rope with a non-metallic jacket, stainless quick disconnect ball joints, and powder coated steel mounting brackets. Some drilling required for installation.



Do it Yourself Limb Riser Cables

See Page 19



DELETE PLATES AND STINGERS



Spare Tire Delete Plates



Made in the USA from 1/8" steel. Uses factory bolts. Available with custom laser images or private labeling.

If you have removed the factory spare tire from your Jeep, you'll want our Delete Plate to cover the unsightly openings in the factory tailgate. Simply bolt on our Delete Plate to clean up the look of your Jeep.

	Bare Metal	J0046866
	Black	J0043675
	Texturized Black	J0043685
	Southwest Blue	J0043678
	Playboy Blue	J0043679
	Neon Green	J0043681
	FL Orange	J0043676
	Locas Green	J0043683
	Military Beige	J0043684
	Pinky	J0043682
	Lemon Peel	J0043680
	Red Baron	J0043677
	Sinbad Purple	J0043687
	Cloud White	J0043688
	Gray Hammett'n	J0043686
	Gecko Green	J0046386
	Hot Pink	J0046387
	Neon Yellow	J0046385
	Hydrographics	J0046923

Grill Guard



J0029546

Grill Guard with Light Bar (lights not included). May require drilling for installation. 5.5" between tube and bumper.

Cosmetic Stingers



This Stinger is cosmetic use only. It won't support the weight of the vehicle in case of a roll over.



Cosmetic Stinger
J0029545



Cosmetic Stinger
With Light Bar
Lights NOT included
J0029544

TEDDY® CARGO NETS

MADE IN THE USA



Cargo Nets

Our Teddy® Cargo Net covers the back half and sides of your TJ Wrangler. The open design allows for great visibility while keeping your cargo inside the vehicle. Made in the USA.

Double back straps allow adjustability and easy installation

2 inch wide webbing



Black Grommets



Black J0046110



Orange J0047020



Blue J0047018



Red J0047021



Gray J0047019

FABRIC TEDDY® TOPS

AMERICAN MADE TOPS



Teddy® Top Solar Screens

Covers front seat only

Our Teddy® Top installs easily in minutes with the supplied bungee balls. Our tops will work with factory hard and soft tops - no need to remove our Teddy® once installed! Made in the USA.



Black
J0041460



Green
J0043710



Orange
J0041461



Yellow
J0043711



White
J0043706



Red
J0043712



Blue
J0043707



Burgundy
J0043713



Gray
J0043708



Dark Green
J0043714



Tan
J0043709



Mauve
J0043715

Hardtop Hardware Kit



J0045490

Stainless Steel components to replace your factory hardtop hardware. Fits TJ and YJ.



Truckster Tops

Give your TJ the advantage of a Steinjäger solar Teddy® Top along with the look of a truck by using our Truckster Top. They fit between the sound bar and roll bar and are installed easily with bungee balls. Made in the USA.



- Black J0043626
- Orange J0043627
- White J0043628
- Blue J0043629
- Gray J0043630
- Tan J0043631

- Green J0043632
- Yellow J0043633
- Red J0043634
- Burgundy J0043635
- Dark Green J0043636
- Mauve J0043859



FABRIC TEDDY® TOPS

AMERICAN MADE TOPS



TJ

Teddy® Top Solar Screens

Covers front and back seats

Our Teddy® Top installs easily in minutes with the supplied bungee balls. Our tops will work with factory hard and soft tops - no need to remove our Teddy® once installed! Made in the USA.



Black
J0045985



Green
J0045991



Orange
J0045986



Yellow
J0045992



White
J0045987



Red
J0045993



Blue
J0045988



Burgundy
J0045994



Gray
J0045989

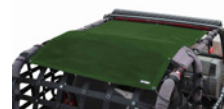

Dark Green
J0045995



Tan
J0045990



Mauve
J0045996

Steinjäger

SWAY BARS

SUSPENSION PARTS & SYSTEMS



Rear Sway Bar Kit

J0030153

J0046947 hydrodipped

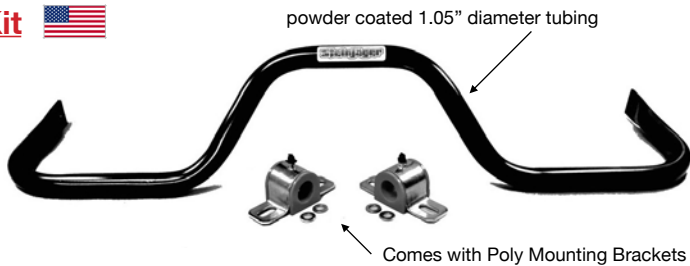

The Steinjäger Rear Sway Bar is constructed from heavy duty 1.050 inch OD x 0.109 inch Wall A513-Type 1 Tubing to help stiffen up the suspension of your Jeep. The Sway Bar is **powder coated** and includes the polyurethane mounting bushings. Our oversized rear sway bar design helps eliminate unwanted body roll. Disconnect the end links attached to this sway bar before serious rock crawling or off-roading. Otherwise, because of the large diameter, articulation will be reduced and hinder your off-road experience. Made in the USA.

Rear Quick Disconnect End Links

Heim Joint has a non-metallic bearing liner for wear resistance

Chrome Plated Washers

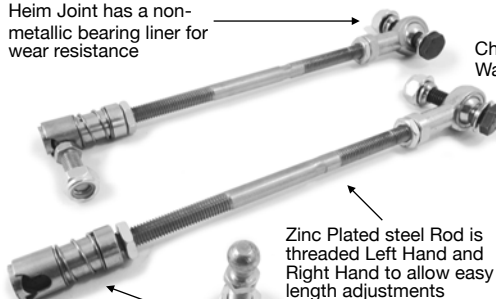

for stock height TJ's **J0031040**
 for 2" lifted TJ's **J0031040**
 for 4" lifted TJ's **J0031040**
 for 6" lifted TJ's **J0031041**

Rear End Links

Chrome Moly Heim Joints with non-metallic bearing liner for wear resistance.

Powder Coated steel hex turnbuckle tubes threaded Left Hand / Right Hand



for stock height TJ's **J0030297**
 for 2" lifted TJ's **J0030298**
 for 4" lifted TJ's **J0030299**
 for 6" lifted TJ's **J0030300**



SWAY BAR END LINKS

SUSPENSION PARTS & SYSTEMS



Front Quick Disconnect End Links

Chrome Moly Heim Joints with non-metallic bearing liner for wear resistance.

Zinc Plated steel Rod is threaded Left Hand and Right Hand to allow easy length adjustments

Chrome Plated Heim Spacer Cones

Powder Coated metal Drop Clevis.

for stock height TJ's **J0030837**
 for 2" lifted TJ's **J0030838**
 for 4" lifted TJ's **J0030839**
 for 6" lifted TJ's **J0030840**

Metal-on-Metal Spring Loaded Ball Joint with 1/2-20 threads provides strength and ease of disconnecting

 • Comes with 2 bungees for tying up end links when disconnected.

Front Pin Style End Links

Chrome Moly Heim Joints with non-metallic bearing liner for wear resistance.

for stock height TJ's **J0028972**
 for 2" lifted TJ's **J0028974**
 for 4" lifted TJ's **J0028975**
 for 6" lifted TJ's **J0028976**

Chrome Plated Heim Spacer Cones

Powder Coated steel hex turnbuckle tubes threaded Left Hand / Right Hand



Sway Bar Hanger Kits

See Page 36



TRACK AND PANHARD SUSPENSION PARTS & SYSTEMS



Front Track Bars

Fits TJ, LJ & XJ

Chrome Moly Heim Joint
Chrome Moly Turnbuckle threaded LH/RH provides double adjustment
Chrome Moly Thread Bungs



Rear Panhard Bars

1.25" OD x 0.120" W Tubing.
DOM & Chrome Moly options

Standard finish is Powder Coating, but hydrographic patterns also available.

Poly bushings come with grease zerks

Chrome Moly Thread Bungs

Plated Steel Turnbuckle threaded LH/RH provides double adjustment

	<i>For 3"-6" Lifts</i>	Chrome DOM Tube	Chrome Moly Tube		<i>For 3"-6" Lifts</i>	Chrome DOM Tube	Chrome Moly Tube
	Black	J0030946	J0044779		Black	J0030945	J0044780
	Texturized Black	J0046150	J0046164		Texturized Black	J0046077	J0046090
	Southwest Blue	J0046143	J0046157		Southwest Blue	J0046070	J0046083
	Playboy Blue	J0046144	J0046158		Playboy Blue	J0046071	J0046084
	Neon Green	J0046146	J0046160		Neon Green	J0046073	J0046086
	FL Orange	J0046141	J0046155		FL Orange	J0046068	J0046081
	Locas Green	J0046148	J0046162		Locas Green	J0046075	J0046088
	Military Beige	J0046149	J0046163		Military Beige	J0046076	J0046089
	Pinky	J0046147	J0046161		Pinky	J0046074	J0046087
	Lemon Peel	J0046145	J0046159		Lemon Peel	J0046072	J0046085
	Red Baron	J0046142	J0046156		Red Baron	J0046069	J0046082
	Sinbad Purple	J0046152	J0046166		Sinbad Purple	J0046079	J0046092
	Cloud White	J0046153	J0046167		Cloud White	J0046080	J0046093
	Gray Hammet'n	J0046151	J0046165		Gray Hammet'n	J0046078	J0046091
	Gecko Green	J0046479	J0046482		Gecko Green	J0046425	J0046428
	Hot Pink	J0046480	J0046483		Hot Pink	J0046426	J0046429
	Neon Yellow	J0046478	J0046481		Neon Yellow	J0046424	J0046427
	Hydrographics	J0046929	J0046930		Hydrographics	J0046933	J0046934

TIE RODS

FOR TJ AND XJ



Tie Rods

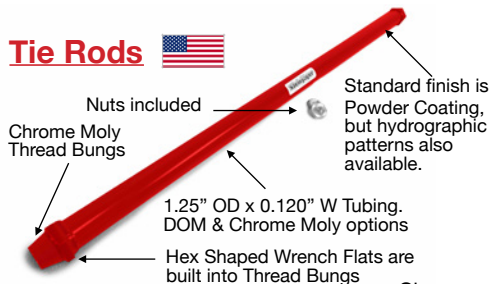

	<u>DOM Tube</u>	<u>Chrome Moly Tube</u>
Black	J0030947	J0031075
Texturized Black	J0046122	J0046136
Southwest Blue	J0046115	J0046129
Playboy Blue	J0046116	J0046130
Neon Green	J0046118	J0046132
FL Orange	J0046113	J0046127
Locas Green	J0046120	J0046134
Military Beige	J0046121	J0046135
Pinky	J0046119	J0046133

	<u>DOM Tube</u>	<u>Chrome Moly Tube</u>
Lemon Peel	J0046117	J0046131
Red Baron	J0046114	J0046128
Sinbad Purple	J0046124	J0046138
Cloud White	J0046125	J0046139
Gray Hammert'n	J0046123	J0046137
Gecko Green	J0046470	J0046473
Hot Pink	J0046471	J0046474
Neon Yellow	<u>J0046469</u>	<u>J0046472</u>



Axle Weld On Tie Down Brackets

Fits JK, JKU, TJ, LJ & XJ



J0031080 2 brackets in kit

Use these handy brackets to create an axle tie down for your Jeep.

Made in the USA from 1/4" steel, these brackets have a 1.625" x 0.625" oval opening that accommodates most standard 'double J' and 'wire' hook strap styles. Flat hooks will not fit.

For the best safety results, make sure any welding is done by a certified welder, and that the mating components are of the same or comparable material.



CONTROL ARMS

SUSPENSION PARTS & SYSTEMS



TJ

Rear Upper Control Arms

2" to 8" Lifts



J0041318 2 arms
• 1.500" x 0.120" W DOM



J0046919 2 arms hydrodipped
• 81 patterns available



Front & Rear Lower Control Arms

2" to 8" Lifts



J0041314 2 arms
• fits Front or Rear
• 1.750" x 0.120" W DOM



J0046915 2 arms hydrodipped
• 81 patterns available

1"-12 Poly Bushing studs, Grade 8



Front Upper Control Arms

2" to 8" Lifts



J0041319 2 arms
• 1.500" x 0.120" W DOM



J0046920 2 arms hydrodipped
• 81 patterns available

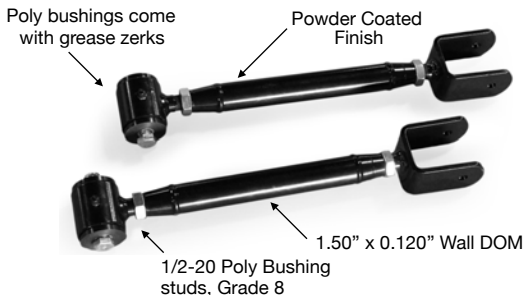

For 0" to 2" Lifts

Front Upper Control Arms



J0041316 2 arms
1.500" x 0.120" Wall DOM

J0046917 2 arms hydrodipped
 • 81 patterns available

Rear Upper Control Arms



J0041317 2 arms
1.500" x 0.120" Wall DOM

J0046918 2 arms hydrodipped
 • 81 patterns available

LONG ARM KITS

MADE IN AMERICA FOR THE TJ



Long Arm Kits

2" to 6" Lifts

- Install Time: 20 to 30 hours
- Requires welding
- Includes 8 double adjustable Control Arms
- Heim Joints are Chrome Moly
- Includes 2 Chassis Mounts
- Includes 1 Transmission Cross Member
- Includes all components shown in photo

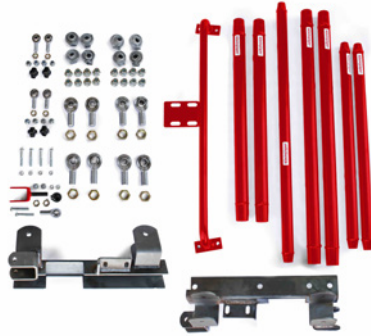

Manual Transmission

Automatic Transmission

	<u>DOM Tubes</u>	<u>Chrome Moly Tubes</u>	<u>DOM Tubes</u>	<u>Chrome Moly Tubes</u>
Black	J0030796	J0030795	J0031113	J0031112
Texturized Black	J0046022	J0046050	J0046036	J0046064
Southwest Blue	J0046015	J0046043	J0046029	J0046057
Playboy Blue	J0046016	J0046044	J0046030	J0046058
Neon Green	J0046018	J0046046	J0046032	J0046060
FL Orange	J0046013	J0046041	J0046027	J0046055
Locas Green	J0046020	J0046048	J0046034	J0046062
Military Beige	J0046021	J0046049	J0046035	J0046063
Pinky	J0046019	J0046047	J0046033	J0046061
Lemon Peel	J0046017	J0046045	J0046031	J0046059
Red Baron	J0046014	J0046042	J0046028	J0046056
Sinbad Purple	J0046024	J0046052	J0046038	J0046066
Cloud White	J0046025	J0046053	J0046039	J0046067
Gray Hammert'n	J0046023	J0046051	J0046037	J0046065
Gecko Green	J0046858	J0046860	J0046859	J0046861
Hot Pink	J0046862	J0046864	J0046863	J0046865
Neon Yellow	J0046854	J0046856	J0046855	J0046857



TUBULAR DOORS

FOR THE YJ, CJ-7 AND CJ-8



TUBULAR DOORS FOR YJ



fits YJ, CJ-7 and CJ-8

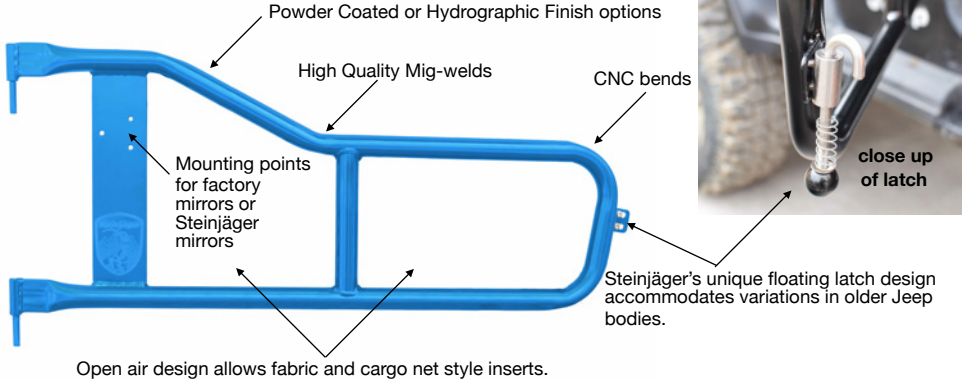

- Bare Metal J0046712
- Black J0043574
- Texturized Black J0043584
- Southwest Blue J0043577
- Playboy Blue J0043578
- Neon Green J0043580
- FL Orange J0043575
- Locas Green J0043582
- Military Beige J0043583
- Pinky J0043581



- Lemon Peel J0043579
- Red Baron J0043576
- Sinbad Purple J0043586
- Cloud White J0043587
- Gray Hammert'n J0043585
- Gecko Green J0046519
- Hot Pink J0046520
- Neon Yellow J0046518
- Hydrographics J0046817

Door Hangers
See Page 47



Arm Rests
See Page 47



Fabric Door Inserts
See Page 48



TUBULAR DOORS

DOOR NETS FOR YJ, CJ-7 & CJ-8



Door Nets for Steinjäger YJ, CJ-7 & CJ-8 Tube Doors

Includes 2 Door Nets and all Bungees.

Made in the USA.

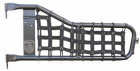
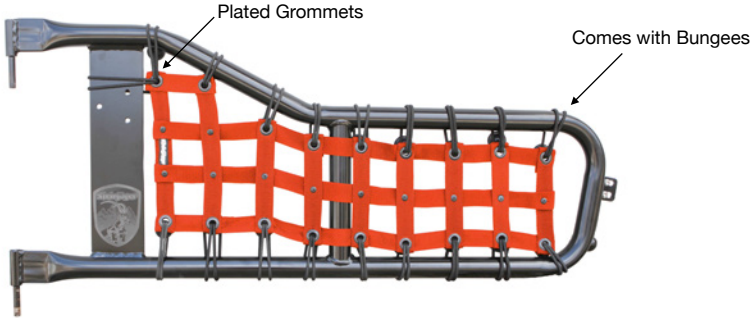

Black J0044923

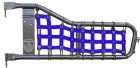

Blue J0044927



Orange J0044926



Orange J0044924

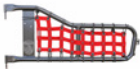

Red J0044925



YJ Door Mirror Kits
See Page 49

Door Limiting Straps

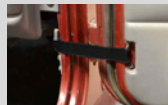

For YJ **stock** doors.
2 Straps per kit.

- Black **J0045473**
- Blue **J0045477**
- Gray **J0045476**
- Orange **J0045474**
- Red **J0045475**



Foot Pegs for YJ
See Page 51



Tube Door Limiting Straps
See Page 46



FABRIC TEDDY® TOPS

AMERICAN MADE TOPS



Teddy® Top Solar Screens

Our Teddy® Top installs easily in minutes with the supplied bungee balls. Our tops will work with factory hard tops. Made in the USA.

Front Cover

Front & Back Covers Sold Separately

Rear Cover

Covers rear seats only with the Family Style Roll Cage.

Does **NOT** work with the Sport Cage.



Black
Front **J0045478**
Rear **J0045505**



Green
Front **J0045484**
Rear **J0045511**



Orange
Front **J0045479**
Rear **J0045506**



Yellow
Front **J0045485**
Rear **J0045512**



White
Front **J0045480**
Rear **J0045507**



Red
Front **J0045486**
Rear **J0045513**



Blue
Front **J0045481**
Rear **J0045508**



Burgundy
Front **J0045487**
Rear **J0045514**



Gray
Front **J0045482**
Rear **J0045509**



Dark Green
Front **J0045488**
Rear **J0045515**



Tan
Front **J0045483**
Rear **J0045510**



Mauve
Front **J0045489**
Rear **J0045516**

FABRIC TEDDY® TOPS

CARGO NET



Teddy® Cargo Nets

Our Teddy® Cargo Net covers the back half and sides of your YJ. You must have the Family Style Roll Cage in your YJ in order for this to fit properly. Easy installation with double back straps. This will fit with your factory top, so there is no need to remove it once it's installed. Made in the USA.

Double back straps allow adjustability and easy installation

2 inch wide webbing

Black Grommets

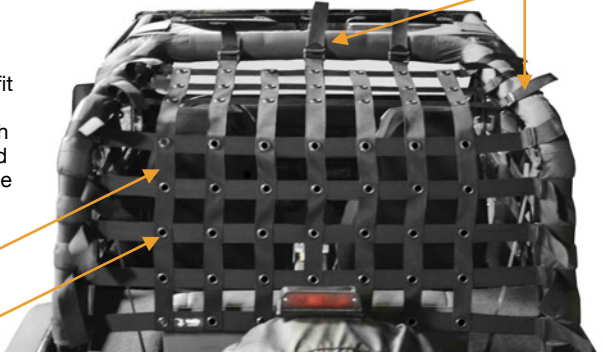

Black
J0046615



Orange
J0047028



Blue
J0047026

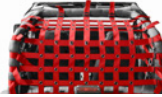

Red
J0047029



Gray
J0047027



Hardtop Hardware K
See Page 56



Coat Hook Kit
See Page 15

DRAG LINKS

MADE IN THE USA FOR YOUR YJ



Drag Links

The Steinjäger Drag Link is a strong alternative to the original factory piece. It is made in the USA from 1.25" OD x 0.120 W DOM tubing. Comes with RH and LH jam nuts.

Standard finish is Powder Coating, but hydrographic patterns also available.

Chrome Moly Thread Bungs

Nuts included

1.25" OD x 0.120" W Chrome Moly Tubing.

Hex Shaped Wrench Flats are built into Thread Bungs to make your toe adjustments easier.

	Bare	J0045816
	Black	J0045817
	Texturized Black	J0045827
	Southwest Blue	J0045820
	Playboy Blue	J0045821
	Neon Green	J0045823
	FL Orange	J0045818
	Locas Green	J0045825
	Military Beige	J0045826

	Pinky	J0045824
	Lemon Peel	J0045822
	Red Baron	J0045819
	Sinbad Purple	J0045829
	Cloud White	J0045830
	Gray Hammer't'n	J0045828
	Gecko Green	J0046455
	Hot Pink	J0046456
	Neon Yellow	J0046454

Shift Knobs

Use this kit to put a new knob on your old manual transmission shifter. The kit includes an adapter and the shift knob.

J0031233 engraved *Steinjäger* logo

J0031234 engraved *When Baad is Good®*

J0031236 engraved with your message/logo



YJ Sway Bar Hanger
See Page 36



SUSPENSION PARTS

FOR YOUR XJ



XJ

Quick Disconnect Front End Links

J0045815 2-4" Lift

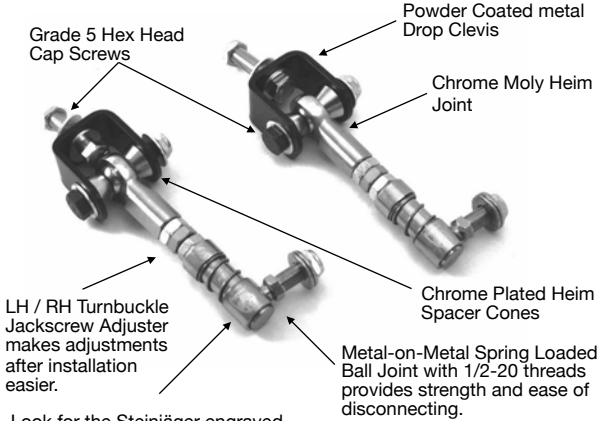

Look for the Steinjäger engraved trademarked Logo to ensure you have genuine Steinjäger End Links!

Replacement Door Pin Kit

J0043671



Replacement door pins are needed to reinstall your factory doors after running doorless. 1 Kit required per door. Kit includes 2 Pins & 2 Cotter pins.

Upper Control Arm Clevis



J0043464

Bore: 0.438"
Length to Eye: 5.75"
Jaw Width: 2.000"
Thread" 3/4-16 LH

Shift Knobs



J0043466

engraved *Steinjäger* logo

J0043467

engraved *When Baad is Good®*



Sway Bar Hangers
See Page 36



Front Track Bars
See Page 60



Axle Tie Down Brackets
See Page 61



Tie Rods
See Page 61

Steinjäger

PARTS FOR CJ-7 & CJ-8

USA MADE FOR CJ-7 AND CJ-8

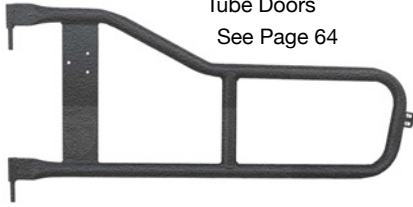

Tube Doors
See Page 64



Door Cargo Net Inserts
See Page 65



Tube Door Mirror Kit
See Page 49

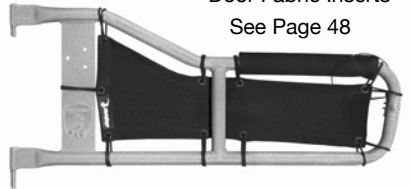

Door Fabric Inserts
See Page 48



Foot Pegs
See Page 51



Door Hanger
See Page 47



Can Holder for Door Hinge
See Page 18



Coat Hook
See Page 15

STEINJÄGER DECALS

Decals

Steinjäger

J0017853 0.750" x 3.10"



J0023975 6" x 8"

J0045034 12" x 18"

Steinjäger

J0017852 2.125" x 4.75"

Steinjäger
Suspensions

J0030943 16.000" x 36.00"



J0046792 3 x 11.5"



J0046793 3 x 11.5"

Perforated Window Decals

Steinjäger
Suspensions

J0028964 12.000" x 24.00"

Steinjäger

J0028963 12.000" x 14.00"

Steinjäger

SPORTSWEAR AND SWAG

STEINJÄGER

Banners



J0030550 30" x 30"

Dog Tags



J0031025 2 sided

Patches (Sew On)



J0023976 2.3" x 3.0"

Tattoos (Temporary)



J0041466 2" x 3"

Black Hats



J0041468 L

Gray Hats



J0041528 L

Pit Shirts



J0017848 XS
J0017849 L
J0017850 XL
J0017851 XXL

Banners



J0045025 30" x 60"

SPORTSWEAR

STEINJÄGER

Our shirts are 100% cotton. Machine Wash. Images printed by us in the USA.



J0029536 S
J0029537 M
J0029538 L



J0029539 XL
J0029540 XXL



J0045014 S
J0030885 M
J0030886 L



J0030887 XL
J0030888 XXL



J0041506 S
J0041507 M
J0041508 L



J0041509 XL
J0041510 XXL



J0041511 S
J0041512 M
J0041513 L



J0041514 XL
J0041515 XXL

Steinjäger
WHEN HARD IS GOOD.

J0046736 S
J0046737 M
J0046738 L

J0046739 XL
J0046740 XXL



Steinjäger

SPORTSWEAR

STEINJÄGER

Our shirts are 100% cotton. Machine Wash. Images printed by us in the USA.



J0045009 S
J0045010 M
J0045011 L

J0045012 XL
J0045013 XXL



J0041496 S
J0041497 M
J0041498 L

J0041499 XL
J0041500 XXL



J0041471 S
J0041472 M
J0041473 L

J0041474 XL
J0041475 XXL



J0041501 S
J0041502 M
J0041503 L

J0041504 XL
J0041505 XXL



J0041491 S
J0041492 M
J0041493 L

J0041494 XL
J0041495 XXL

SPORTSWEAR

STEINJÄGER

Our Hoodies are a 50/50 blend of cotton with spandex cuffs, a front pouch pocket, relaxed waistband, and fully cover seamed. Printed by us in the USA.



Black



J0041550 S
 J0041551 M
 J0041552 L
 J0041553 XL
 J0041554 XXL

Blue



J0041530 S
 J0041531 M
 J0041532 L
 J0041533 XL
 J0041534 XXL

Gray



J0041545 S
 J0041546 M
 J0041547 L
 J0041548 XL
 J0041549 XXL

Orange



J0041535 S
 J0041536 M
 J0041537 L
 J0041538 XL
 J0041539 XXL

Pink



J0041540 S
 J0041541 M
 J0041542 L
 J0041543 XL
 J0041544 XXL

Printed by us in the USA

